



 **deltalab**  
member of **SCGP**

General Catalogue



[www.deltalabgroup.com](http://www.deltalabgroup.com)



[communication@deltalabgroup.com](mailto:communication@deltalabgroup.com)



Plaza de la Verneda, 1.  
P. I. La Llana. 08191. Rubí.  
Barcelona, Spain.



+ 34 93 699 50 00



+ 34 93 699 45 12

The image shows a rectangular box containing the text "FSC".

FSC

All rights reserved. No part of this catalogue may be reproduced without the prior permission in writing of DELTALAB S.L.

All information presented in this catalogue is correct except in the case of typing errors. DELTALAB S.L. reserves the right to alter the characteristics of products presented in our catalogue when said changes are beyond control of this company.



**Dear Customers, Distributors, Suppliers and Friends,**

It is a great occasion to address you through this new edition of DELTALAB's Catalogue 2025.

Deltalab member of SCGP, the Group of Companies situated in Europe and Asia, focus on providing labware, medical ware and laboratory solutions with advanced technology, through our history of 48 years. To date, it can be said that quality, innovation, product variety, and response to the requirements of our customers for ultimate satisfaction have shaped the essence of the value we provide as you can see in this DELTALAB'S Catalogue 2025.

At Deltalab member of SCGP, our people share a common mission and set of core values: innovation, quality, service, efficiency and sustainability. These are always linked and executed to our daily work, with emphasis on placing customers' priorities first. We think globally, act locally, and envision the next future. With our professional and creative team, we foresee, analyze, redesign, and develop the best solutions for accelerating research & innovation, improving healthcare and diagnostic challenges; automation, accuracy, reliability, speed-, promoting laboratory productivity and capability across industries, as well as taking responsibility to protect environment. Our continual strategies on increase in R&D and Innovation, co-creation with our stakeholders, investment in the right production scale of pioneer product, and keeping up with regulatory evolution are the key to success in the fast moving & competitive global markets. It is anticipate that these will enhance your success too.























We hope you find this new edition of our Catalogue to be useful tool to understand and appreciate the broad & remarkable scope of products that meet your needs and expectations. As we continue to bring new products to market, we also welcome the opportunity to collaborate on any product ideas you may have.

Your invaluable trust, collaboration and partnership are sincerely appreciated.

**Pongsuda Pongtanya, PhD**  
Managing Director

## NOMENCLATURE

---

- 

Stackable
- 

Graduated
- 
Alphanumeric Identification
- 
Floats
- 
DNase and RNase free
- 



Autoclavable  
(see more information about autoclaving in page 300)
- 
Suitable for PCR
- 
Suitable for QPCR (Real Time PCR)
- 
High resistance tube
- 
Packaged in bags
- 
Product suitable for food use
- 
New
- 
Directive 98/79/EC or Regulation 2017/746  
(in Vitro Diagnostic medical device)
- 
Directive 93/42/EEC or Regulation 2017/745  
Class I or Class Is (sterile) (low risk medical device)
- 
Directive 93/42/EEC or Regulation 2017/745  
Class IIa (Moderate risk, sterile medical device)
- 
Regulation 2016/425  
(Personal protective equipment)

The technical data (dimensions, capacities and resistances) specified in this catalogue are approximated.  
The resistances (to chemical products, temperature, centrifugation...) may suffer variations depending on external conditions.  
We recommend to test the product under the forecasted conditions of use. Please do not hesitate to ask for samples if necessary.

## DELTALAB ISO CERTIFICATIONS

Deltalab's Quality Management System is certified as per ISO 9001:2015 and ISO 13485:2016 standards.

Since August 2019, Deltalab has been granted the **ISO 14001:2015 Certification**. This standard ensures that our companies have an Environmental Management System, which allows us to control the environmental impact of our products and activities. Deltalab, being a company **committed with the environment protection**, has decided to implement the mentioned Environmental Management System to reduce as much as possible the environmental impact.

The plastic materials of the products manufactured and commercialized by Deltalab are of high quality and are adequate to the needs of every product. For example, they are suitable for food contact, free of latex and other harmful substances such as heavy metals, phthalates, bisphenol or asbestos. Provided the products made of plastic are not chemically polluted, they are fully recyclable and biodegradable, and must be disposed of following the law in every country.

The packaging cardboard materials used in for the products commercialized by Deltalab are biodegradable and recyclable. To ensure a responsible management of the natural resources, these materials follow the FSC guidelines.

### CERTIFICATIONS OF THE INTEGRATED MANAGEMENT SYSTEM (quality and environment)



ISO 9001: 2015  
Quality management systems.



ISO 13485:2016  
Medical devices.  
Quality management systems.  
Requirements for regulatory purposes.



ISO 14001: 2015  
Environmental management systems

## **CE MARK OF MEDICAL DEVICES (MD) AND MEDICAL DEVICES FOR IN VITRO DIAGNOSTICS (IVD)**

---

The CE Mark concerns those products that, affecting human beings, may involve a risk to their health. Therefore the CE Mark warrants that a product has been designed and manufactured so that it complies with the following requirements:

- **Does not compromise the health or clinical status of a patient.**
- **Does not endanger the user's health or safety.**
- **Does not compromise the health or safety of third parties.**
- **Minimizes the risk of errors of use thanks to its ergonomic features and the environment in which it is intended to be used.**
- **It takes into account the technical knowledge, expertise, experience, training, and medical and physical conditions of the intended users.**

The CE Mark requires that facilities, work organisation, and systems are subject to rigorous both internal and external quality controls. It also guarantees the highest level of safety when using those products intended for the sample collection and handling of human samples, directly and also for taking human clinical samples and their subsequent in vitro diagnosis.

The CE Mark guarantees that the products will be freely commercialised within the European Union.

## MEDICAL DEVICES (MD)

---

According to Regulation UE N° 2017/745 on Medical Devices (that will replace Directive 93/42/CEE) a Medical Device is any instrument, apparatus, appliance, software, implant, reagent, material or other article intended by the manufacturer to be used, alone or in combination, for human beings for one or more of the following specific medical purposes:

- Diagnosis, prevention, monitoring, prediction, prognosis, treatment or alleviation of disease,
- Diagnosis, monitoring, treatment, alleviation of, or compensation for, an injury or disability,
- Investigation, replacement or modification of the anatomy or of a physiological or pathological process or state,
- Providing information by means of in vitro examination of specimen derived from the human body, including organ, blood and tissue donations, and which does not achieve its principal intended action by pharmacological, immunological or metabolic means, in or on the human body, but which may be assisted in its function by such means.

This Regulation, that will enter into force in May 2020, establishes 4 categories of medical devices, depending on the risk (time of contact and invasivity). DELTALAB manufactures and commercialises products of transient use classified as **Class I (sterile and non-sterile) and Class IIa:**

- **Class I (Non sterile):**

- **Low risk, invasive medical devices**

- It includes: non sterile tongue depressors, speculums, etc. Inspection gloves are considered both as MD Class I and PPE (Personal Protective Equipment). All of them are self-certification products, so No Notified Body is required.

- **Class I (sterile):**

- **Low risk, sterile, invasive medical devices**

- Among others: sterile tongue depressors, sterile Ayre spatulas, sterile cytology brushes, flocked swabs with and without transport media. They are certified by a Notified Body.

- **Class IIa (sterile):**

- **Moderated risk, sterile surgically invasive medical devices**

- This includes traditional swabs with and without transport medium and Deltaswab® flocked swabs with and without transport medium. Certification by a Notified Body is required.

- The CE Mark allows these swabs to be used in surgical operations as an invasive product.**



## **MEDICAL DEVICES FOR IN VITRO DIAGNOSTIC (IVD)**

---

According to Regulation EU N° 2017/746 on medical devices for in vitro diagnosis (that will replace Directive 98/79/EC), an in vitro medical device is “any medical device which is a reagent, reagent product, calibrator, control material, kit, instrument, apparatus, piece of equipment, software or system, whether used alone, solely or principally for the purpose of providing information on one or more of the following:

- concerning a physiological or pathological process or state;
- concerning congenital physical or mental impairments;
- concerning the predisposition to a medical condition or a disease;
- to determine the safety and compatibility with potential recipients;
- to predict treatment response or reactions;
- to define or monitoring therapeutic measures.

Specimen receptacles shall also be deemed to be in vitro diagnostic medical devices;

Specimen receptacles means a device, whether of a vacuum-type or not, specifically intended by its manufacturer for the primary containment and preservation of specimens derived from the human body for the purpose of in vitro diagnostic examination. Examples: Urine analysis bottles, blood extraction tubes, tubes with means of transport for combined use with swabs, capillaries, enrichment media, etc.

Medical Devices for in vitro diagnosis are not considered material for general laboratory use .

## **PPE PRODUCTS (Personal Protective Equipment)**

---

According to Regulation EU N° 2016/425m that repeals Directive 89/686/EEC, a PPE product is “any device or system to be worn or used by a human being, which protects him from one or various risks that may endanger his health and/or security”.

Security glasses and protection gloves are included. Inspection gloves are considered both as Medical Device and PPE as they protect the user while being a low risk, invasive medical device.

## USEFUL INFORMATION

---

### PRODUCT PACKAGING

#### SYMBOLS USED IN LABELING AND INFORMATION ON MEDICAL DEVICES

(in accordance with UNE-EN ISO 15223-1: 2016)

	Manufacturer		Do not use if package is damaged
	Manufacturing date		Temperature limit
	Batch code		Do not reuse
	Catalogue number		Consult instructions for use
	Sterilized using aseptic processing techniques		Caution
	Sterilized using ethylene oxide		In vitro diagnostic medical device
	Sterilized using irradiation		Medical device
	Unique sterile barrier system		Unique device identifier
	Use-by date		Website with information for the patient

## TRANSPORT

---

- **CONTAINERS: CAPACITY:**

- 20 feet: 28 m<sup>3</sup> maximum
- 40 feet: 58 m<sup>3</sup> maximum
- 40 HC feet: 68 m<sup>3</sup> maximum

\* Calculated package by package, not by pallet, for maximum space optimization.

- **PALLETS:**

- maximum air transport height: 1.50 m
- maximum height land transport: 2.40 m
- maximum height sea transport: 2.10 m
- width x depth european pallet: 80 x 120 cm
- width x depth american pallet: 100 x 120 cm

## SALES CONDITIONS

---

- Goods are shipped at the purchaser's risk and on the purchaser's account.
- Goods are considered delivered, and at the responsibility of the purchaser, from their shipment from our warehouses. Any problem of transport or other is therefore the entire responsibility of the purchaser from that moment.
- Goods delivered are the property of DELTALAB S.L. until paid in full. In case of discrepancy, we will be governed by the courts of Barcelona.
- **MINIMUM ORDERING QUANTITY** (per total order): According to our price list.
- **MINIMUM ORDER QUANTITY** (per product): In those products indicated, it is possible to acquire minor quantities from the standard selling unit. In those cases, a surcharge is applied in order to cover the manipulation costs. Orders over the standard selling unit must be multiple of this standard selling unit. Orders must be in complete case quantities unless indicated otherwise.
- **ORDERS:** They must be made in writing, indicating the item code, name, units, price or offer. In case of doubt, the product code will take precedence.
- **CLAIMS AND RETURNS:** Any claim on the items in our catalogue must be made in writing within the deadlines indicated in the current price rate and its return requires the prior authorization of DELTALAB S.L. The customer must indicate the code, lot and delivery note number of the product subject to the claim.  
  
Returns of products with sterile CE marking or items made of materials suitable for contact with food are not accepted.
- **PACKAGING:** Our products are properly packaged and coded (code, description, quantity and lot number). This catalog indicates weights and volumes in kilograms and cubic meters.
- **SPECIAL AND CUSTOM PRODUCTS:** We can supply some customized products, with another cap colour, other containers or packaging, etc. Consult our sales department.

You can see our current complete sales conditions at DELTALABs Price list

**For reasons which are beyond our control we reserve the right to modify the product specifications.**

## SUMMARY

---

	01	Microbiology	10
	02	Cell culture. Molecular biology	58
	03	Hematology. Biochemistry	80
	04	Histology. Microscopy and staining	96
	05	Containers. Sampling	120
	06	Tubes, microtubes and cryovials	148
	07	Cold storage	170
	08	Liquid handling	182
	09	Sample storage	208
	10	Hygiene, safety and general labware	238
	11	Laboratory and industrial packaging	276
	12	Technical information and index	296



# 01. MICROBIOLOGY

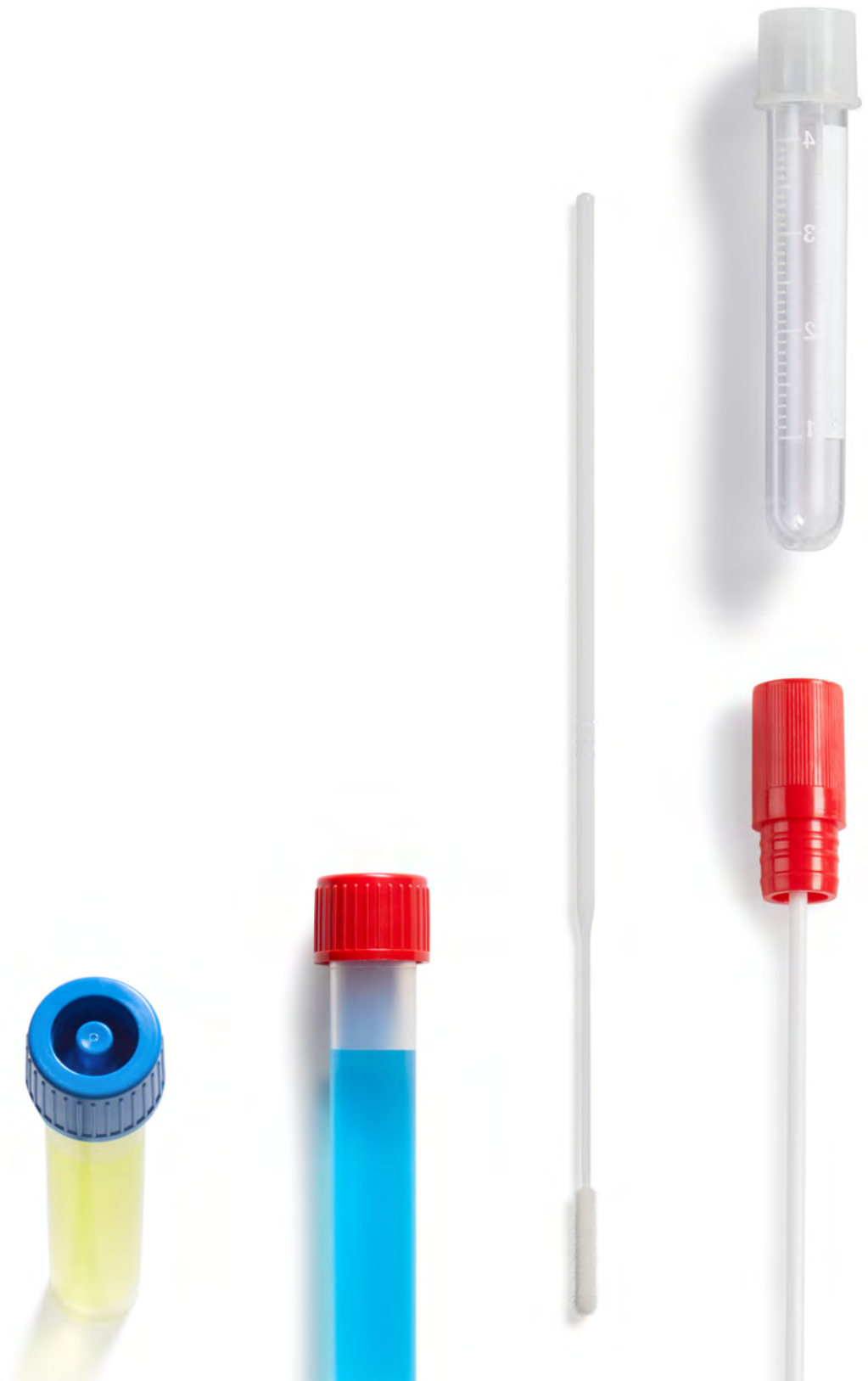

## SWABS FOR MICROBIOLOGICAL SAMPLING

- Swabs are used for biological sampling.
- Specially used for processing samples which, after being coloured, will be analysed by microscopy.
- Also suitable for isolations in culture medium.
- Another important use is its capacity to spread dishes by dissemination techniques (for example for susceptibility testing by Kirby-Bauer or by E-test).

## STERILE SWABS

The swabs intended for the collection and transport of microbiological samples are considered invasive medical devices for temporary use. As such, they comply with the safety and performance requirements determined by EU Regulation 2017/745 (on medical devices).

According to the rules of classification of this Regulation these swabs belong to class IIa since they are of surgical use.

The **Centro Nacional de Certificación de Productos Sanitarios** (CNCps - ON nº0318) is the institution who notified these swabs.

## QUALITY STANDARDS – REQUIREMENTS FULFILLED BY STERILE SWABS

1. UNE-EN ISO 556-1 Sanitary products sterilisation. Requirements to be designed as “STERILE”. Part 1: sterilized sanitary products requirements. Requirements for medical devices in their terminal state.
2. UNE-EN ISO 868-5 Packaging materials for medical devices sterilised in their final stage. Part 5: Sealable bags and rolls made of porous materials and plastic film. Requirements and test methods.
3. UNE-EN ISO 11737-1 Sterilization of medical devices. Microbiological methods. Part 1: determination of a population of microorganisms.
4. UNE-EN ISO 11737-2 Sterilization of medical devices. Microbiological methods. Part 2: Sterility tests performed for the definition, validation and maintenance of a sterilization process.
5. UNE-EN ISO 11135-1 Sterilization of medical devices. Ethylene oxide. Part 1: requirements for development, validation and control of the routine of a sterilization process of medical devices.
6. UNE-EN ISO 11137-1 Sterilization of health care products. Radiation. Part 1: requirements for the development, validation, and control of the routine of a sterilization process of PS.
7. UNE-EN ISO 11137-2 Sterilization of health care products. Radiation. Part 2: setting the sterilization dose.
8. UNE-EN ISO 15223-1 Sanitary products. Symbols to use on labels, labelling and information to be supplied. Part 1: general requirements.
9. UNE-EN ISO 14971 Sanitary products. Application of risk on management.
10. UNE-EN ISO 13485 Sanitary products. Systems of quality management. Requirements for regulatory purposes.



## SWABS USE ACCORDING TO THE MATERIAL

### SWAB HEADS

Made of various materials, including cotton, polyester and viscose. Each swab contains more or less 0.04g of fiber and its absorption capacity is 0.2-0.3ml, with cotton usually having a better absorption of liquid, although the difference is minimal.

- **Cotton/Pure Cotton:**

Fibrous substance, white and soft. Being a vegetable fiber can include traces of some substance (fatty acids, oils, etc.) that affect labile or demanding microorganisms.

- **Polyester (Dacron):**

For use in direct antigen, PCR, IFA tests. Its drawback is that it contains fatty acids and inhibitory detergents. It has flame retardant properties.

- **Viscose (Rayon):**

Artificial silk obtained from cellulose. It is a more aseptic material and the one with less inhibitory effects has in bacterial growth. Therefore, it is the best material for cell recovery.

- **Flocked fibres:**

Material with high absorption and overall sample elution.



### SWABS SHAFT

The shaft is available in different materials according to its application: In wood, in polystyrene (breakable without leaving splinters) and also in aluminum.

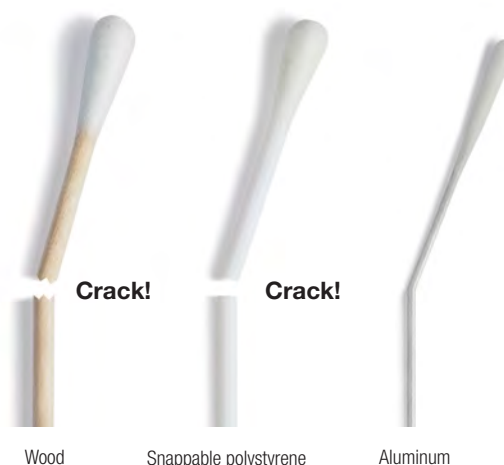

## PRESENTATIONS



**In bulk:**  
the non-sterile swabs presented in bags of 100 units.



**Peel-pack package:**  
Plastic unit bag - plastic or medical paper - plastic (according to reference).



**Flow-pack package:**  
single bag. Polypropylene bioriented bag.



**Package in polypropylene tube:**  
The product is identified on the label, that acts as a seal.

All the above packages have the following parameters printed on: product code, product description, lot number, expiry date, CE mark, manufacturer name and address, sterilisation method and single use mark (Ⓢ).



## TRADITIONAL SWABS WITHOUT TRANSPORT MEDIUM

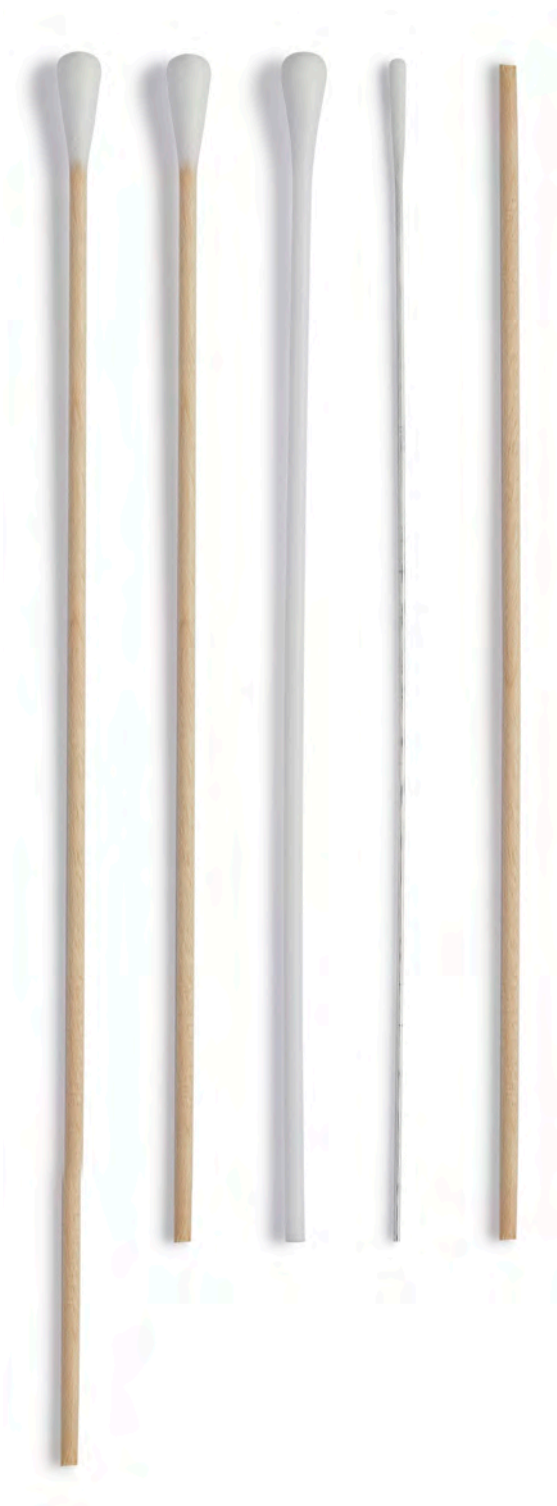

### Non sterile swabs

Non-sterile swabs presented in bags of 100 units, except code **300205**, supplied bulk.

#### Dimensions:

**300232:** 200 x 2.5 mm. Tip 5 mm de diameter.

**300230:** 150 x 2.2 mm. Tip 5 mm de diameter.

**300260:** 150 x 2.5 mm. Tip 5 mm de diameter.

**300260.1:** 150 x 2.5 mm. Tip 5 mm de diameter.

**300243:** 147 x 2.5 mm. Tip 5 mm de diameter.

**300205:** 147 x 2.2 mm.

Model **300232** is longer than the traditional swabs and is designed for those hard to reach places.

For use in **gynaecology** when taking endocervical cells while using the speculum.



code	shaft material	tip material	case quantity	case weight	case volume
<b>300232</b>	extra large wood (200 mm)	cotton	80 x 100	5.0	0.032
<b>300230</b>	standard wood (150 mm)	cotton	100 x 100	4.65	0.032
<b>300260</b>	polypropylene	cotton	40 x 100	2.5	0.012
<b>300260.1</b>	polystyrene	viscose	40 x 100	2.5	0.014
<b>300243</b>	aluminum	cotton	100 x 100	2.8	0.005
<b>300205*</b>	wooden shaft only	-	1 x 1,000	2.5	0.010

\* Non CE product.

Expiry date: 60 months

## Sterile swabs

Sterile swabs individually wrapped in peel-pack or flow pack, depending on the model. **Sterilized.**

For use when samples do not need to be transported.

It is recommended our transport swabs in tubes when sample transport is required (see next page).

1. Flow-pack: plastic.
2. Peel-pack: plastic + plastic.

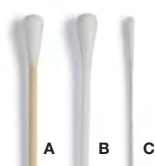

A: Wood  
B: Snappable polystyrene  
C: Aluminum



code	shaft material	tip material	sterile	package	case quantity	case weight	case volume
300200	wood	cotton	STERILE R	peel-pack	2 x 1,000	2.25	0.029
310200	wood	cotton	STERILE R	flow-pack	2 x 1,000	2.60	0.029
300201	snappable PS	cotton	STERILE R	peel-pack	2 x 1,000	3.52	0.027
300202	snappable PS	viscose	STERILE R	peel-pack	2 x 1,000	3.50	0.029
310202	snappable PS	viscose	STERILE R	flow-pack	2 x 1,000	2.02	0.029
300203	aluminum	cotton	STERILE EO	peel-pack	2 x 1,000	2.40	0.029

Cases per pallet: 54.

Expiry date: 48 month.



## Sterile swabs (2 units)

Two Sterile swabs wrapped in peel-pack, depending on the model. **Sterilized by ethylene oxide.**

One swab is designed for cleaning the sampling area.

The other swab is designed for sample collection.

For use when samples do not need to be transported.

It is recommended our transport swabs in tubes when sample transport is required 1,000 peel-packs with 2 units each one per case.

Peel-pack: medical paper + plastic.



code	shaft material	tip material	sterile	package	case quantity	case weight	case volume
300210	wood	cotton	STERILE EO	peel-pack	1.000	2.65	0.024
300212.1	snappable PS	viscose	STERILE EO	peel-pack	1.000 peels	2.72	0.025

Cases per pallet: 54.

Expiry date: 48 month.





### Sterile swab in round tube

Sterile dry swabs supplied in shockproof round bottom polypropylene tube, with a label sealing the cap.

**Dimensions of tube:** Ø 13 x 165 mm.

**Sterilized by ethylene oxide.**



code	shaft material	tip material	case quantity	case weight	case volume	cases per pallet
300250	wood	cotton	4 x 500	14.00	0.060	24
300261	snappable PS	cotton	4 x 500	14.90	0.070	24
300252	snappable PS	viscose	4 x 500	15.00	0.066	24
300263	snappable PS	polyester	4 x 500	15.00	0.062	24
300251	aluminum	cotton	4 x 500	15.00	0.066	24
300253	aluminum	viscose	4 x 500	13.90	0.070	24

**Expiry date:** 48 months



### Human DNAsa, RNAsa and DNA free certified swabs, sterile

**Human DNA free Certified. Sterilized by ethylene oxide.**

The swab is supplied in a polypropylene tube, which protects the sample up to the laboratory prior to its analysis. The stick of the swab is made of polystyrene while the head is produced with viscose or polyester according to the code. The tube is labeled indicating code, description, lot, expiry date and providing an identifying area to note down collection details (site, date, etc.). Moreover, the label seals the tube with the cap of the swab, acting like a tamper evident system.



code	shaft material	tip material	selling unit	case quantity	case weight	case volume
300252DNA	polystyrene	viscose	500	4 x 500	14.20	0.070

**Expiry date:** 48 months

This product is not considered a medical device and does not carry CE marking because it is not for a subsequent diagnosis of a pathology, but is designed for saliva sampling, for genetic analysis (identification of human DNA) within the scope of the investigation and the forensic market.

## TRANSPORT SWABS WITH MEDIA



Manufactured in Clean Room  
+  
Sterilized by Radiation

### Safety

- Paperless, plastic peel-pack is an extraordinary safe system to maintain pack integrity and sterility

### Comfort

- Space saving
- Collapsible internal case
- Easy warehouse identification
- Selling unit easy to commercialize
- New standardised pack quantity for all our swabs
- The peel-pack has a small slit at the top to allow easy opening

### Information

- Full range of transport medias listed on the package
- Clear dual CE Marking IVD + MD printed in both, peel-pack and case
- Instructions for use printed on the peel-pack and on the inner box. Also available online.

### Design

- Attractive peel-pack and friendly users guide
- Dimensions of the peel-pack: 38 x 210 mm
- Eye-catching case designed exclusively for swabs
- Drawings of a swab and a tube on both the peel-pack and the case for first sight identification

### Traceability

- Each single peel-pack is printed with the catalogue number, UDI, lot number, expiry date and product description.
- Both external and internal cases are also identified with catalogue number, UDI, lot number, expiry date and product description.

### Environmentally friendly

- Peel pack made of one material only: easy recycling!

## CE SWABS:

As the two main components of a transport swab have different purposes and different ways of interaction with the patient, both have different CE treatment:

1. **Swab:** for microbiological sample collection. As a surgical invasive product of temporary use, is classified as CLASS IIa product in compliance with EU Regulation 2017/745.
2. **Tube:** with transport and preservation media container facilitator of survival and transport of biological samples prior to analysis. Classified as in vitro diagnostic IVD (according to EU Regulation No. 2017/746, which replace Directive 98/79/EC).

## TRANSPORT MEDIA:

The media used to transport the sample, has the appropriate chemical composition that maintains the bioburden levels with the minimum physiological activity, achieving thus the minimal quantitative and qualitative variation of the sample from the collection to its analysis.

## COMPONENTS:

Each set consists in a tube and a swab, packed in a peel-pack bag (A) and sterilized by radiation.

- (B) **Tube with transport media:** Made of rigid polypropylene with round bottom.
- (C) Polyethylene **cap** specially designed to close hermetically; non slippery surface when using gloves.
- (D) Coloured **label** in each tube with the following parameters printed: transport media type, sterilisation method, manufacturer name, CE mark, "single use" and "see the instructions" marks, lot number and expiry date, as well as spaces to write patient name, date, time, medical report number, source and kind of sample. The label seals the cap and the tube.
- (E) **Swab** fitted in a second cap with a shaft which ends in a tip of synthetic or organic material hardly adhered to the shaft. The cap provides a leakproof seal after sample collection.

Both the peel-pack package and the label of the tube are printed with the following information: transport media type, sterilization method, manufacturer name, **CE** mark, "single use" and "see the instructions" marks, lot number, and expiry date. Peel pack also includes UDI.



## Amies. Sterile

Universal transport media for bacteria in microbiological samples. It is a modification of the medium Cary Blair, itself of the medium Stuart. Basically, the glycerophosphate is changed from the original composition to inorganic phosphate and methylene blue for neutral pharmaceutical coal. In addition, it adds calcium and magnesium ions, which help preserve the permeability of the bacterial cell. This media assures the viability of organisms such as:

- Neisseria sp.
- Haemophilus sp.
- Corynebacterium sp.
- Trichomonas vaginalis*
- Streptococcus pyogenes*
- Streptococcus pneumoniae*
- Shigella flexneri*
- Salmonella typhi*
- Brucella abortus*
- Enterobacterias, etc.

The presence of charcoal on the media neutralises inhibitors and bacterial toxins, and improves the recovery ratio of *Neisseria gonorrhoeae* and *Vibrio cholerae*

Some microorganisms can resist on the media for up to 3 days, although the recovery of microorganisms is better if cultured in the first 24 hours. Amies transport swabs are available with or without charcoal.

**Swabs are sterilized by radiation.**

**Expiry date:** 30 months.



code	shaft material	tip material	case quantity	case weight	case volume
300287	snappable PS	viscose	6 x 100	9.33	0.059
300285*	snappable PS	viscose	6 x 100	9.37	0.058
300281	aluminum	viscose	6 x 100	9.08	0.056
300281/1*	aluminum	viscose	6 x 100	9.15	0.052

\*Amies with charcoal included.  
Cases per pallet: 32.

## Liquid Amies. Sterile

This is a variation of the traditional Amies media swab where the media is presented as liquid form without agar. Suitable for conservation of pathogens such as:

- Haemophilus sp.
- Corynebacterium sp.
- Trichomonas vaginalis*
- Streptococcus pyogenes*
- Streptococcus pneumoniae*
- Shigella flexneri*
- Salmonella typhi*
- Brucella abortus*
- Neisseria gonorrhoeae*
- Staphylococcus epidermidis*
- Escherichia coli, etc.

**Swabs are sterilized by radiation.**

**Expiry date:** 30 months.



code	shaft material	tip material	case quantity	case weight	case volume
300284.SE	snappable PS	viscose	6 x 100	7.60	0.055

Cases per pallet: 32.



## Stuart swabs. Sterile

The modified Stuart media allows the conservation and transportation of a large number of pathological microorganisms, such as:

*Neisseria gonorrhoeae*  
*Haemophilus influenzae*  
*Neisseria meningitidis*  
*Bordetella pertusis*  
*Corynebacterium diphtheriae*  
*Trichomonas vaginalis*  
*Staphylococcus aureus*  
*Streptococcus* sp.  
*Salmonella* sp.  
*Shigella* sp.  
 etc.

The most unstable organisms will remain viable for up to 24 hours and other for several days. The media is reduced due to the presence of thioglycolate, which diffcults the enzymatic reactions of the bacteria. The multiplication of the bacteria is prevented due to the lack of nitrogen in the media.

Swabs are **sterilized by radiation**.

**Expiry date:** 30 months from sterilisation date.



code	shaft material	tip material	case quantity	case weight	case volume
300290	wood	cotton	6 x 100	9.40	0.057
300291	aluminum	cotton	6 x 100	9.10	0.057
300295	snappable PS	viscose	6 x 100	8.65	0.060

Cases per pallet: 32.



## Cary Blair. Sterile

Cary Blair is another modification of Stuart media.

The glycerophosphate has been substituted by inorganic phosphate since glycerophosphate is a metabolite for some bacteria, so they could grow and disperse the pathogens amount.

The methylene blue has also been removed and the pH increased to 8.4. This is a media originally developed for faecal samples but is also used successfully for anaerobic transport, such as:

*Neisseria gonorrhoeae*  
*Vibrio cholerae*  
*Vibrio parahaemolyticus*  
*Haemophilus influenzae*  
*Neisseria meningitidis*  
*Streptococcus pneumoniae*  
*Shigella flexneri*  
*Pasteurella pestis*  
*Campylobacter* Spp., etc.

Swabs are **sterilized by radiation**.

**Expiry date:** 30 months from sterilization date.



code	shaft material	tip material	case quantity	case weight	case volume
300280	wood	cotton	6 x 100	8.50	0.052
300280.2	snappable PS	viscose	6 x 100	8.50	0.056

Cases per pallet: 32.





## Chlamydia. Sterile

Liquid media, suitable for Chlamydia.  
For cervical samples it is recommended to firstly use a dry swab to clear the cervical channel.

**Sterilized by radiation.**  
**Expiry date: 12 months.**



code	shaft material	tip material	case quantity	case weight	case volume
<b>300299.SE</b>	snappable PS	polyester	6 x 100	7.80	0.056

Minimum order quantity: 100 units.  
Cases per pallet: 32.



## FLOCKED SWABS WITHOUT TRANSPORT MEDIUM

Deltalab offers a wide range of flocked swabs, with or without breaking point, that perform the most efficient absorption and elution for the collection of microbiological samples. These swabs are presented in tube or flow-pack without transport medium.



mod.	code	description	breakpoint mm	case quantity	case weight	case volume
1	300264	Dry swab PS + flocked standard 100mm in tube	100 mm	4 x 500	14.20	0.065
2	300267	Dry swab PS + flocked nasopharyngeal 100mm in tube	100 mm	4 x 500	14.20	0.065
3	310206K	Dry swab PS + flocked standard 80mm in Flow-pack	80 mm	2 x 1000	2.02	0.029
4	310207K	Dry swab PS + flocked nasopharyngeal 80mm in Flow-pack	80 mm	2 x 1000	2.02	0.029



## FLOCKED BRUSHES WITH LIQUID TRANSPORT MEDIUM



Range of swabs for the collection and transport of microbiological samples in liquid medium. The Deltaswabs system is compatible with automation equipment for inoculation and seeding of samples, as well as with molecular diagnostic techniques. Compared to traditional swabs, with this range we obtain:

1. Greater reliability in sample recovery: high absorption and elution capacity of the flocked swab.
2. Greater sample viability since it remains completely suspended in the medium.
3. It allows obtaining different homogeneous inocula from the same sample.
4. It adapts to any work protocol.

In addition, possible cross-contamination is minimized due to less handling and maximum tightness. The patient obtains greater comfort thanks to the softer swab cover. The Deltaswab system allows direct spreading on the slide, as it does not contain the agar medium and ensures the correct transport and storage of samples both at room temperature (20°C-25°C) and at refrigeration temperature (4°C-8°C).

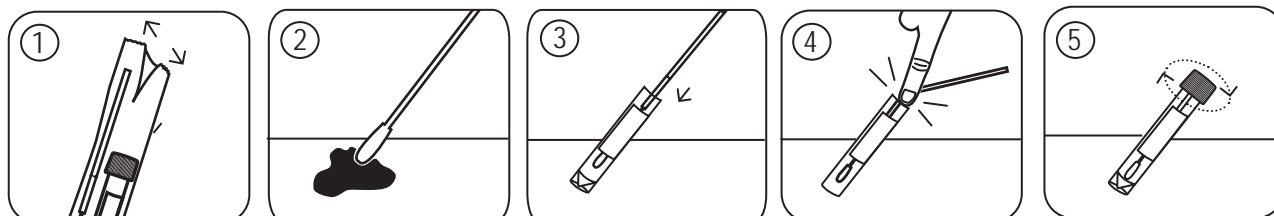
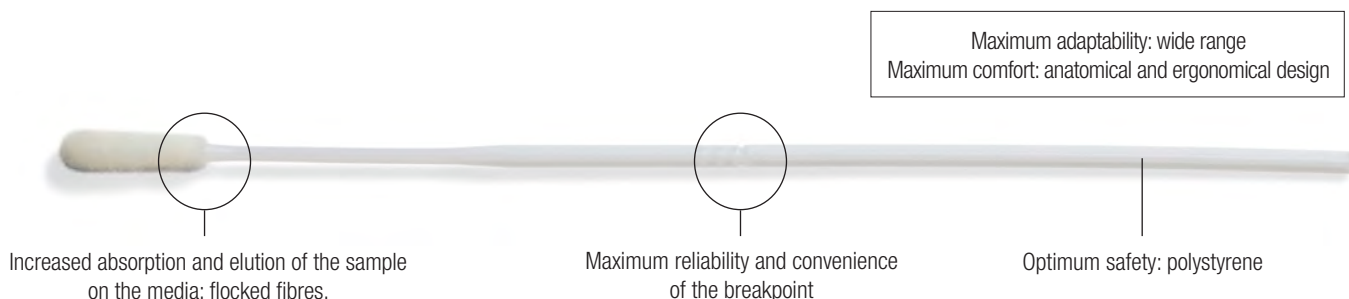



## FLOCKED SWABS WITH LIQUID TRANSPORT MEDIUM

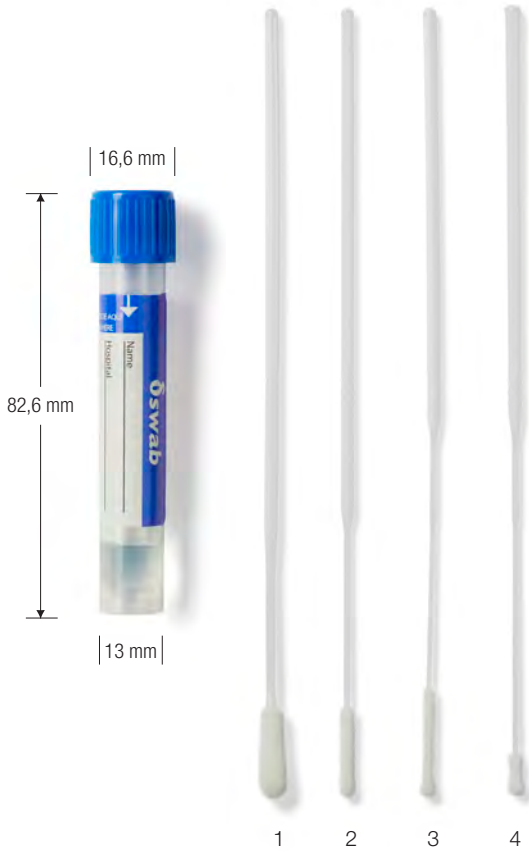

### Amies

Particularly suited for microbiological sample collection and transport. It maintains the viability of Aerobes, Facultative Anaerobes and Anaerobes Bacteria for a minimum of 48 hours both at room temperature (20-25°C) and at refrigeration temperature (2-8°C) and 24 hours with Fastidious Bacteria, following CLSI Quality Control of Microbiology Transport System: Approved Standard - Second Edition. Designed both for traditional and automated sample streaking.

Compatible with the molecular diagnostic techniques and for direct extension on glass slides.

Peel-pack package.

**Brush: radiation sterile.**

**Tube: sterile by aseptic techniques.**



mod.	code	ml	description	breakpoint mm	case quantity	case weight	case volume
1	304221KF	1	with standard flocked swab	80	6 x 100	5.6	0.056
2	304222KF	1	with urethral flocked swab	80	6 x 100	5.6	0.056
3	304223KF	1	with nasopharyngeal flocked swab	80	6 x 100	5.7	0.056
4	304224KF	1	with minitip flocked swab	80	6 x 100	5.7	0.056
3	304225F	1	with nasopharyngeal flocked swab	100	6 x 100	5.6	0.056

Expiry date: 30 months.



### Cary Blair

Specially suited for the collection and transport of faecal samples. Maintains the viability of the fecal pathogens for a minimum of 48 hours without overgrowth, following CLSI Quality Control of Microbiology Transport System: Approved Standard - Second Edition. Designed for carrying out sample collection directly from the rectum or from faeces.

Designed for traditional and automated sample streaking. Compatible with the molecular diagnostic techniques by PCR and for direct extension on glass slides.

Peel-pack package.

**Brush: radiation sterile.**

**Tube: sterile by aseptic techniques.**



code	ml	description	breakpoint mm	case quantity	case weight	case volume
304260KF	2	with standard flocked swab	80	6 x 100	6.3	0.056

Expiry date: 24 months.



## VICUM®

Particularly suited for collecting and transporting microbiological samples which contain Virus, Chlamydia, Ureaplasma and/or Mycoplasma. Includes antibiotics which inhibit the growth of Bacteria and Fungi; this ensures reliability in terms of sample recovery. Maintains the infectability of viruses for a minimum of 96 hours both at room temperature (20-25°C) and at refrigeration temperature (2-8°C), following CLSI Quality Control of Microbiology Transport System: Approved Standard - Second Edition. Each tube contains glass beads to facilitate cell lysis, sample homogeneousness and maximize the elution of the sample from the swab. Designed for cell cultivation and compatible with molecular diagnostic techniques by quantitative PCR.

Flow-pack package, except for code 304233.2S presented in peel-pack.

**Brush: radiation sterile.**

**Tube: sterile by aseptic techniques.**



mod.	code	ml	description	breakpoint mm	case quantity	case weight	case volume
1 B	304238KF	2	with standard flocced swab	80	6 x 90	6.59	0.056
2 B	304236KF	2	with urethral flocced swab	80	6 x 90	6.59	0.056
3 B	304234KF	2	with nasopharyngeal flocced swab	80	6 x 90	6.59	0.056
3 B	304230F	2	with nasopharyngeal flocced swab	100	6 x 90	6.59	0.056
4 B	304239KF	2	with minitip flocced swab	80	6 x 90	6.59	0.056
1 A	304233F	3	with standard flocced swab	100	6 x 70	8.91	0.056
1/3A	304233.2S	3	with 2 standard flocced swab / nasopharyngeal	100	6 x 40	5.09	0.056

Expiry date: 24 months

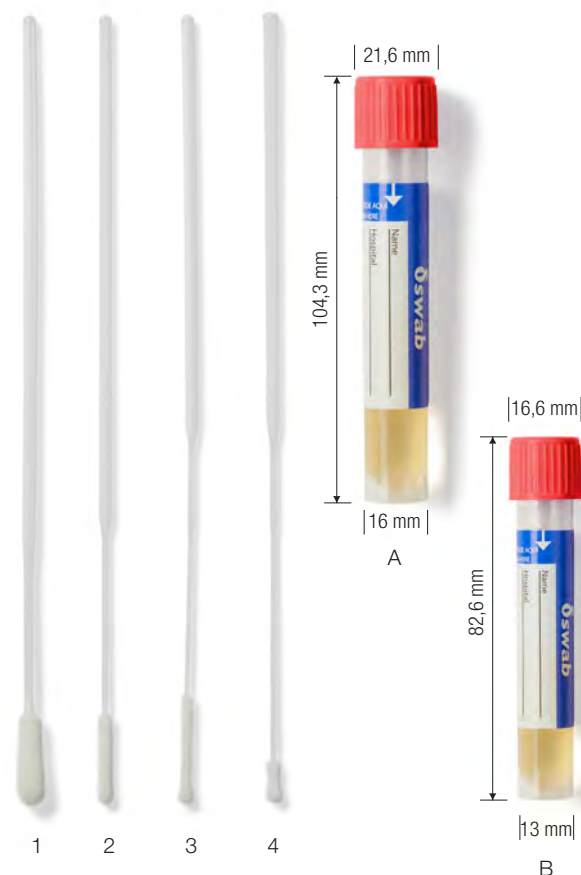

## Virus

Particularly suited for collecting and transporting microbiological samples which contain viruses. By including antibiotics which inhibit the growth of Bacteria and Fungi, it ensures the trustworthiness of the sample.

It maintains the infectability of viruses for up to 96 hours, both at room temperature (20-25°C) and at refrigeration temperature (4-8°C), following CLSI Quality Control of Microbiology Transport System: Approved Standard - Second Edition.

Designed for cell cultivation and to be compatible with the molecular diagnostic techniques by quantitative PCR.

Peel-pack package.

**Brush: radiation sterile.**

**Tube: sterile by aseptic techniques.**



mod.	code	ml	description	breakpoint mm	case quantity	case weight	case volume
1	304243KF	1	with standard flocced swab	80	6 x 100	5.7	0.056
2	304305KF	1	with nasopharyngeal flocced swab	80	6 x 100	5.5	0.056
1-2	304305KF.2S	3	with standard + nasopharyngeal flocced swab	80	6 x 100	6.7	0.056
Virus medium with inactivating							
2	304305KFI	3	with standard flocced swab	80	6 x 100	5.7	0.056
1	304243KFI	3	with nasopharyngeal flocced swab	80	6 x 100	5.5	0.056

Expiry date: 18 months





ENRICHMENT MEDIA



LIM Broth

Selective enrichment medium for Group B Streptococcus, including *S. agalactiae*. The kit consists of a tube with conical bottom, skirted and screw cap, containing 2 ml LIM broth, and a standard flocked swab. Packed in peel pack (plastic peel pack) with the basic information and instructions printed.

**Brush: radiation sterile.**  
**Tube: sterile by aseptic techniques.**



code	description	tube height mm	cap Ø mm	case quantity	case weight	case volume
304213KF	2 ml LIM	82.6	16.6	6 x 90	6.59	0.056

Expiry date: 16 months



Selenite

Enrichment medium that inhibits the proliferation of bacterial microbiote. It is particularly suited for isolating *Salmonella* from faecal samples, food and/or water. It is used as an enrichment medium for clinical and industrial samples. Easy and practical. Compatible with manual and automated systems of microbiological culture and suitable for molecular assays.

**Sterile by aseptic techniques.**



code	description	tube height mm	cap Ø mm	case quantity	case weight	case volume
304210	2 ml Selenite	82.6	16.6	6 x 60	2.84	0.025

Expiry date: 24 months



Thioglycolate

Widely used enrichment medium for isolation and cultivation of Aerobic and Anaerobic Bacteria and Fastidious Bacteria. It is used as an enrichment media for clinical samples. Easy and practical. Compatible with manual and automated systems of microbiological culture and suitable for molecular assays.

**Sterile by aseptic techniques.**



code	description	tube height mm	cap Ø mm	case quantity	case weight	case volume
304211	2 ml Thioglycolate	82.6	16.6	6 x 60	2.84	0.025

Expiry date: 12 months

## CRYOINSTANT: Cryoplashes for the conservation of microbiological strains

Sterile system for the conservation of microbiological strains (for example, fungi in sporulation phase), consisting of a 2 ml cryovial with a skirt, containing 25 glass cryoprobes treated with cryoprotectants that act as a preservative.

Thanks to this system we can:

- Have a **perfect medium of conservation**
- Obtain up to **25 replicas** of the same microbial generation to use progressively for years
- Facilitate the inoculation of the bacteriological medium, since each pearl is equivalent to a culture
- Avoid the defrosting of the entire vial every time we extract a pearl
- Avoid the formation of ice crystals in recovery
- **Minimize the risk of cross contamination**
- **Save freezer space**

### COMPONENTS

The cryovial is made of polypropylene and is externally threaded. Resists up to **-190 °C**. Long skirt cap, with silicone gasket To facilitate the classification of samples, our cryovials are offered with caps and pearls in five different colors (except code 409113/6, which is an assortment).

This system allows rapid identification of the sample, differentiating each type of microorganism according to the colour of the cap and the pearl. The cryovials are presented in a rack of 100 units, made of cardboard resistant to **-100 °C**. Each box is supplied labeled with indication of code, batch, expiration, cap colour, and shrink wrapped.

**Rack dimensions:** 150 x 150 x 55mm. (More information about these boxes on page 214. See code M-600).

**Expiration:** 48 months from the date of manufacture. **Sterile by autoclave.**

### HOW TO USE

1. Take the strain sample using a loop (see our loops on page 38 and 39).
2. Inoculate the vial by inserting the loop into the preservative medium.
3. Close the vial and shake it gently so that the strain is impregnated in the cryoplashes.
4. Extract the remaining preservative medium using a Pasteur pipette (see our Pasteur pipettes on pages 198-203).
5. Close the cryovial and freeze.
6. Every time we want to reproduce the strain, we will extract one of the cryoplashes with a loop or a clamp.
7. We will place the cryop pearl on a plate with medium, ensuring that the entire surface of the pearl enters in contact with the medium.

code	cap and pearls colour	case quantity	case weight	case volume
409113/1	○	100	0.59	0.002
409113/2	●	100	0.59	0.002
409113/3	●	100	0.59	0.002
409113/4	●	100	0.59	0.002
409113/5	●	100	0.59	0.002
409113/6	assorted: 5 colours x 20 cryovials	100	0.59	0.002

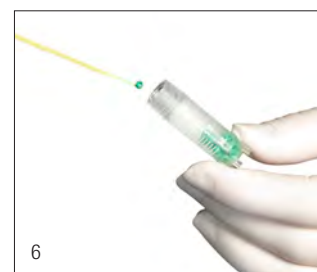

# Self-sampling kits for the detection of sexually transmitted diseases

Detalab presents the new self-sampling kits for the diagnosis of sexually transmitted infections.

These kits are designed and prepared so that the non-professional user can take the sample or samples from his or her own body without any difficulty.

The self-sampling kit facilitates the diagnosis of this type of diseases, avoiding any embarrassment on the part of the affected person, who can take the sample calmly and privately in their own safe space.



## Nasal self-sampling kit with virus medium

Sterile invasive system for self-sampling with virus transport medium for subsequent microbiological analysis. Especially indicated for the collection and transport of microbiological samples containing viruses. By including antibiotics that inhibit the growth of bacteria and fungi, it ensures suitability in sample recovery. Maintains the viability of viruses for up to 96 hours both at room temperature and refrigeration. Designed for cell culture and to be compatible with molecular diagnostic techniques.

- Tube with 3 ml of virus transport medium with a mauve cap indicating the type of transport medium.
- Standard flocked swab with a breaking point at 80 mm.
- Presentation in peel-pack.



code	description	case quantity	case weight	case volume
304244K	3 ml virus medium + standard flocked swab	6 x 60	2.84	0.025

Regulation (EU) 2017/745 on medical devices (MDR). **Expiry date:** 18 months.

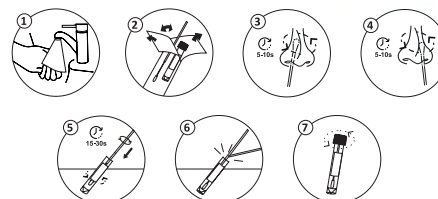

## Kit for the detection of sexually transmitted infections

Sterile invasive system for self-sampling by direct contact with the patient, with and without transport medium, for the purpose of subsequent in vitro diagnostic testing. The product is intended for use by lay users (non-professionals). Product intended for self-sampling in different anatomical areas oral (A), vaginal/ urethral (B) and rectal (C).

- 3 sets 304221KF consisting of a standard swab + tube with AMIES transport medium.
- 2 sets 304238KF consisting of a standard swab + tube with VICUM® transport medium.
- 1 set E300016KP.2 consisting of two thin swabs.
- Stickers labelled A, B1, B2 or C to stick to the tubes with transport medium after taking the samples.



code	description	case quantity	case weight	case volume
200390	(3 sets) 304221KF + (2 sets) 304238KF + (1 set) E300016KP.2	14	4.00	0.056

Regulation (EU) 2017/745 on medical devices (MDR). **Expiry date:** 24 months.



## Vaginal self-sampling kit

Sterile invasive product for self-collection of vaginal samples by lay users for subsequent sending to the clinical laboratory, for the purpose of performing a subsequent examination by in vitro diagnosis.

- A standard flocked swab with a breaking point at 100 mm.
- 12ml round-bottom tube with skirt, in a single bag.
- Presentation of the set in peel-pack.



code	description	case quantity	case weight	case volume
1 200391	standard flocked brush bagged in flow-pack + 12ml tube	6 x 60	2.84	0.025
2 200392	standard flocked brush in tube + 12ml tube	6 x 60	2.84	0.025

Regulation (EU) 2017/745 on medical devices (MDR). **Expiry date:** 48 months.

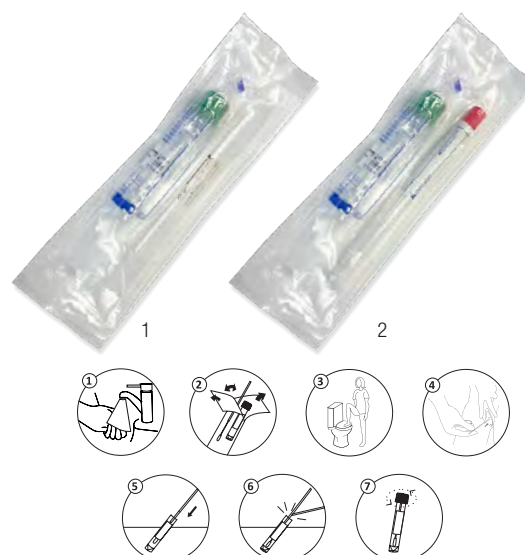

# Surface control for the food industry

MICROBIOLOGY

The presence of pathogenic microorganisms in controlled environments in manufacturing facilities can be detrimental to the final product, the consumer, as well as the company. Bacteria, molds and yeasts are found everywhere in our environment.

DeltaKlean is a variant of the swab sampling method, as it combines the swab test with a specific culture medium, and provides us with a result of the presence or absence of the target microorganism.

A reliable, convenient and easy-to-perform analysis and control system that will take food safety to the next level.



## Swab for surface control: Aerobic

Swab with culture medium and growth indicator for the analysis of microbial load directly from surfaces. The medium includes an additive to indicate biological activity.

### Interpretation of results

A colour change from yellow to pink is indicative of moderate microbial growth on the surface. A colour change from yellow to red is indicative of heavy microbial growth on the surface.



Absence of microbial growth

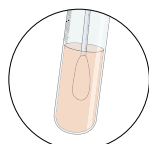

Moderate microbial growth

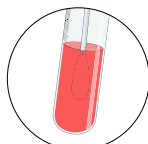

Strong microbial growth

### Microbiological control

*Staphylococcus aureus* ATCC® 25923, WDCM 00034: Good - medium pink/red.

*Escherichia coli* ATCC® 25922, WDCM 00013: Good - medium pink/red.

*Enterococcus faecalis* ATCC® 19433, WDCM 00009: Good - medium pink/red.

*Proteus mirabilis* ATCC® 29906, WDCM 00023: Good - medium pink/red.

Detection range of 10-50 CFU.

Incubation at 37±1°C reading at 18-24 h.



code	description	case quantity	case weight	case volume
200180	Swabs for Aerobic control	25	2.84	0.025



## Swab for surface control: Listeria spp

Swab with culture medium and growth indicator for the detection of Listeria spp. directly from surfaces. The medium includes a pH indicator to indicate biological activity.

### Interpretation of results

A colour change from amber to black is indicative of the presence of Listeria spp. on the surface.

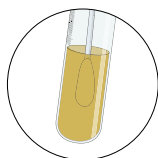

Absence of Listeria spp.

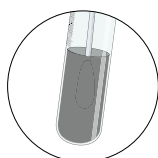

Presence of Listeria spp.

### Microbiological control

*Escherichia coli* ATCC® 25922, WDCM 00013: Inhibited - yellow medium.

*Enterococcus faecalis* ATCC® 19433, WDCM 00009: Inhibited - yellow medium.

*L. monocytogenes* ATCC® 35152, WDCM 00109: Good - black medium.

*Listeria innocua* ATCC® 33090, WDCM 00017: Good - black medium.

Detection range of 10-50 CFU.

Incubation at 37±1°C reading at 18-24 h.



code	description	case quantity	case weight	case volume
200181	Swabs for control of Listeria spp	25	2.84	0.025





## Swab for surface control: Salmonella spp

Swab with culture medium and growth indicator for the detection of *Salmonella* spp. directly from surfaces. The medium includes a pH indicator to indicate biological activity.

### Interpretation of results

A colour change from red to red/black is indicative of the presence of *Salmonella* spp on the surface. A colour change from red to yellow/black is indicative of the presence of Coliforms on the surface.

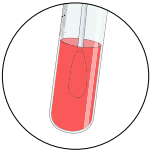

Absence of *Salmonella* spp

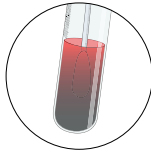

Presence of *Salmonella* spp

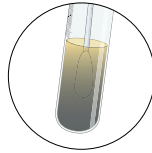

Absence of Coliforms

### Microbiological control

*Salmonella typhimurium* ATCC® 14028, WDCM 00031: Good - medium black/red.

*Salmonella enterica* ATCC® 13076, WDCM 00030: Good - medium black/red.

*Escherichia coli* ATCC® 25922, WDCM 00013: Good - medium yellow.

*Citrobacter freundii* ATCC® 8090: Good - medium yellow.

*Shigella flexneri* ATCC® 12022: Good - medium yellow.

*Enterococcus faecalis* ATCC® 29212, WDCM 00087: Inhibited - medium red.

Detection range of 10-50 CFU.

Incubation at 37±1°C reading at 18-24 h.



code	description	case quantity	case weight	case volume
200182	Swabs for <i>Salmonella</i> spp control	25	2.84	0.025



## Swab for surface control: Molds and yeasts

Swab with culture medium and growth indicator for the analysis of moulds and yeasts directly from surfaces. The medium incorporates a pH indicator to indicate biological activity.

### Interpretation of results

A colour change from violet to amber is indicative of molds and/or yeasts on the surface.



Absence of yeasts and/or molds



Presence of yeasts and/or molds

### Microbiological control

*Escherichia coli* ATCC® 25922, WDCM 00013: Inhibited - medium violet.

*Enterococcus faecalis* ATCC® 19433, WDCM 00009: Inhibited - medium violet.

*Candida albicans* ATCC® 10231, WDCM 00054: Good - medium yellow.

*Aspergillus brasiliensis* ATCC® 16404, WDCM 00053: Good - medium yellow.

*S. cerevisiae* ATCC® 9763, WDCM 00058: Good - medium yellow.

Detection range of 10-50 CFU.

Incubation at 37±1°C reading at 18-24 h.



code	description	case quantity	case weight	case volume
200183	Swabs for mold and yeast control	25	2.84	0.025



## Swab for surface control: E.Coli and Coliforms

Swab with culture medium and growth indicator for the detection of E. coli and coliforms directly from surfaces. The medium includes a pH indicator to indicate biological activity.

### Interpretation of results

A colour change from yellow to green is indicative of the presence of Coliforms on the surface. A colour change from yellow to blue in the presence of UV-A fluorescence is indicative of the presence of E. coli on the surface.



Absence of E.Coli and Coliforms

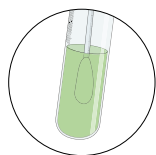

Presence de Coliforms

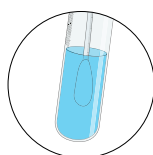

Presence de E.Coli

### Microbiological control

*Escherichia coli* ATCC® 25922, WDCM 00013: Good - Medium blue - Fluorescence.  
*Escherichia coli* ATCC® 8739, WDCM 00012: Good - Medium blue - Fluorescence.  
*Citrobacter freundii* ATCC® 43864, WDCM 00006: Good - Medium blue - No fluorescence.

Detection range of 10-50 CFU.

Incubation at 37±1°C reading at 18-24 h.



code	description	case quantity	case weight	case volume
200184	Swabs for E. Coli and Coliform control	25	2.84	0.025



## Surface Kit

Surface kits are supplied with a swab and a tube containing a buffered broth with neutralising agents. Kits are intended for surface sampling for subsequent microbiological analysis.

The kit is a single use product and is **sterilized by radiation**.

The swab is composed of a polystyrene support with a breakpoint (only reference **200398**) and a viscose tip. The tube incorporates a pressure or screwed cap.

Presented in unit packaging in peel-pack format.

Available the mismo kit with medium peptona, consult with the sales department.

See Whirl-Pak bags for surface areas on page 57.



1

Recommended for food, cosmetic, environmental, veterinary and pharmacy industry, among others.

mod.	code	description	sterile	case quantity	case weight	case volume
1	200398	10 ml neutralising broth in skirted tube + viscose swab	STERILE R	2 x100	4.50	0.030
2	200399	5 ml neutralising broth in non skirted tube + viscose swab	STERILE R	6 x100	10.26	0.0560
	200396P	Plantilla para muestreo superficies 4x5	no	20	0.75	0.0051

Expiry date: 18 months.



2





### 90 x 14 mm Petri Dish

Made in polystyrene. Supplied in groups of 20 units, packaged in heat sealed bags. Codes **200200 & 200200E** are **aseptic** and codes **200209 & 200209E** are **sterile by radiation**. Suitable for automatic filling machines.

code	description	sterile	aseptic	case quantity	case weight	case volume	cases per pallet
<b>With three vents</b>							
200200	Ø 90 x 14 mm	no	✓	25 x 20	7.32	0.071	28
<b>NEW</b> 200200E*	Ø 90 x 14 mm	no	✓	25 x 20	7.32	0.071	28
200209	Ø 90 x 14 mm	<b>STERILE R</b>	✓	25 x 20	7.39	0.071	28
<b>NEW</b> 200209E*	Ø 90 x 14 mm	<b>STERILE R</b>	✓	25 x 20	7.39	0.071	28
<b>Non vented dishes for anaerobic culture</b>							
200200.4	Ø 90 x 14 mm	non	✓	25 x 20	6.90	0.071	28

\* New mold installation to increase production capacity.



### 90 x 14 mm Petri Dish, two compartments

Made in polystyrene. **Aseptic**. With three vents. Supplied in groups of 20 units, packaged in heat sealed bags. Suitable for automatic filling machines.

code	description	aseptic	case quantity	case weight	case volume	cases per pallet
200202	Ø 90 x 14 mm 2 compartments	✓	25 x 20	7.75	0.072	28



### 90 x 14 mm Petri Dish, three compartments

Made in polystyrene. **Aseptic**. With three vents. Supplied in groups of 20 units, packaged in heat sealed bags. Suitable for automatic filling machines.

code	description	aseptic	case quantity	case weight	case volume	cases per pallet
200203	Ø 90 x 14 mm 3 compartments	✓	25 x 20	7.82	0.070	28



### 90 x 15 mm Petri Dish, four compartments

Made in polystyrene. **Aseptic**. Vented. Supplied in groups of 24 units, packaged in heat sealed bags. Suitable for automatic filling machines.

code	description	aseptic	case quantity	case weight	case volume	cases per pallet
200210	Ø 90 x 15 mm 4 compartments	✓	24 x 25	9.20	0.077	28

### Petri Dish 90 x 15 mm with internal cross

Made in polystyrene. **Aseptic.**  
 With four vents. Stackable.  
 With a mark on a side that helps orientation and a writing area on the bottom.  
 Supplied in groups of 25 units, packaged in heat sealed bags.  
 Suitable for automatic filling machines.  
 Internal cross guarantees a totally flat base.

code	description	aseptic	case quantity	case weight	case volume	cases per pallet
200200.5	Ø 90 x 15 mm internal cross	✓	24 x 25	7.50	0.076	20



### 90 x 25 mm Petri Dish

Made in polystyrene. **Aseptic.**  
 Supplied in groups of 24 units, packaged in heat sealed bags.  
 Suitable for automatic filling machines.

code	description	aseptic	case quantity	case weight	case volume	cases per pallet
200215	Ø 90 x 25 mm	✓	24 x 13	8.63	0.076	24



### 140 x 20 mm Petri Dish

Made in polystyrene. With three vents.  
 Suitable for automatic filling machines.  
 Code **200214** is **aseptic**.  
 Code **200219** is **sterile by radiation**.

code	description	sterile	aseptic	case quantity	case weight	case volume	cases per pallet
200214	Ø 140 x 20 mm	no	✓	11 x 15	7.40	0.074	30
200219	Ø 140 x 20 mm	<b>STERILE R</b>		11 x 15	7.25	0.072	30

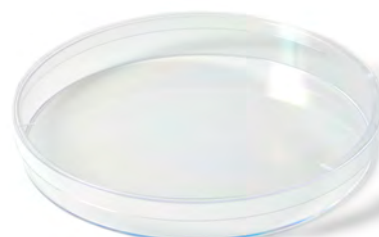

### 120 x 120 mm squared Petri Dish

Made in polystyrene. **Aseptic.** With four vents.  
 Supplied in groups of 10 units, packaged in heat sealed bags.  
 Suitable for automatic filling machines.

code	description	aseptic	case quantity	case weight	case volume	cases per pallet
200204A	120 x 120 mm	✓	24 x 10	11.18	0.072	28



### 55 x 14 mm Petri Dish

Made in polystyrene. With three vents.  
 Supplied in groups of 15 units, packaged in heat sealed bags.  
 Suitable for automatic filling machines.  
 Code **200201** is **aseptic**.  
 Code **200201.B** is **sterile by radiation**.

code	description	sterile	aseptic	case quantity	case weight	case volume	cases per pallet
200201	Ø 55 x 14 mm	no	✓	80 x 15	8.40	0.068	30
200201.B	Ø 55 x 14 mm	<b>STERILE R</b>		80 x 15	8.46	0.068	30





## Petri dish baskets

These stainless steel baskets are suitable for dishes of diameter up to 10 cm.  
Two models available to hold 16 or 32 Petri dishes.

We can supply customer-designed models.

code	description	L x W x H mm (height without handle)	case quantity	case weight	case volume
H-600	1 section, holds up to 16 dishes	105x110x250	1	0.13	0.005
H-601	2 sections, holds up to 32 dishes	105x215x250	1	0.31	0.009

Height with handle: 360 mm.

## Jar for anaerobiosis incubation

### Anaerobic Petri dish incubation system.

Jar of methacrylate designed for use with any anaerobiosis that generate special atmospheres.

Up to 14 90mm diameter petri plates.

Metal cap fixed by locking pressure system.

Stainless steel rack.

Viton® O-ring.

Compatible with all the usual reagents in microbiology.

Available cover in blue or red.



code	dimensions* (mm)	cover colour	case quantity	case weight	case volume
H-626	125 x 260	blue	1	1.17	0.0072
H-627	125 x 260	red	1	1.17	0.0072

\*Diameter x height.

## Contact plates

**Aseptic production.** Used in the pharmaceutical industry, hospital environments for determining bacterial contamination of surfaces such as the skin, operating tables, refrigerated gondolas, and work surfaces.

They are manufactured in transparent polystyrene.

The moulded grid at the bottom makes it possible to identify the detected contamination per cm<sup>2</sup> and it facilitates the counting of colonies.

**Stable stacking:** The shape of the lid makes stacking perfectly stable during transport and incubation, and saves space on work surfaces.

**Dimensions of the dish:** 65,7 mm x 14,7 mm height.

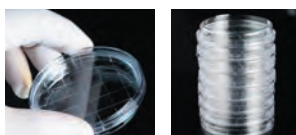

code	description	sterile	case quantity	case weight	case volume	cases per pallet
200208	Rodac contact plate	no	25 x 20	5.00	0.031	70
200218	Rodac contact plate	<b>STERILE R</b>	25 x 20	4.90	0.030	70

## Moulded contact plate rack

Useful for safe transport and incubation of Rodac contact plates and helpful to streamline bench top sample processing. Each rack holds up to 60 contact plates with lids (minimum diameter: 65 mm, maximum diameter: 72 mm) configured in six columns of ten plates. Up to 4 racks can be stacked together, and all interlocked to prevent accidental knock over. Access slots under each stack of contact plates allows a stack of plates to be safely removed from the rack using a secure ring that places a finger under the bottom plate and thumb on top of the lid of the top plate. A large centre divider provides space for labelling and incorporates a handle. All parts are moulded with white polypropylene and are steam **autoclavable at 121 °C**. Racks are supplied individually bagged, flat, and can be easily assembled (instructions included).



code	dimensions* (mm)	case quantity	case weight	case volume
H-610	266 x 165 x 178	1	0.39	0.002

\*Lenght x width x height.

## Moulded 90 or 100 mm Petri dish rack

Useful for safe transport and incubation of 90 or 100 mm Petri dishes and helpful to streamline bench top sample processing.

Each rack holds up to forty-two Petri dishes with lids, configured in interlocked columns of seven plates. Up to 4 racks can be stacked together, and all interlock to prevent accidental knock over. Access slots under the bottom Petri dishes allows a stack of dishes to be safely removed from the rack using a secure ring that places a finger under the bottom dish and thumb on top of the lid of the top dish.

All parts are moulded with white polypropylene and are steam **autoclavable at 121 °C**. Racks are supplied individually bagged, flat, and can be easily assembled (instructions included).



code	dimensions* (mm)	case quantity	case weight	case volume
H-611	330 x 210 x 178	1	0.40	0.005

\*Lenght x width x height.



### Stackable Petri dish incubation tray

This polypropylene tray increases overall capacity of the incubator. Designed to hold five 100 mm diameter or fifteen 60 mm diameter Petri dishes, it's provided with two large label areas for critical sample identification by marker or label.

With 16 vents.

**Not autoclavable.**



code	dimensions (mm)	case quantity	case weight	case volume
H-615	251 x 35 x 237	3	0.82	0.011

### Microtitre plates, sterile

Made of high transparency polystyrene.

Standard 96-well plates.

**Three models available depending on the bottom of the well.**

- **Flat bottom plates ("LI" shaped plate)** are more suitable for optical reading (for example, by means of a spectrophotometer). They are also suitable for cell culture in suspension, as well as for those ELISA applications in which the treatment of the surface is not required to improve the adhesion between the plate and the antigen or antibody.
- The **tapered bottom plates ("V" shaped plate)** are very practical when you need to recover the entire sample or to separate components by centrifugation. They can be used for complementing the fixation technique
- **Round bottom plates ("U" shaped plate)** are also used to recover the entire sample or to separate components by centrifugation.

Other applications:

- Dilution
- Preparation of serial samples
- Protein precipitation
- Haemagglutination

The cover, in transparent polystyrene, is supplied separately (codes **900015** or **900015.1**).

These plates can also be covered using the transparent sealing film or the plate sealing mat (see page 68).

Both sterile and non-sterile models are supplied in an individual bag.

**Dimensions of the plate:** 127.7 x 85.8 mm.

code	description	sterile	well plate estimate volume	case quantity	case weight	case volume
<b>900010</b>	microtitre plate "U" form	<b>STERILE R</b>	281 µl	50	2.15	0.013
<b>900010.1</b>	microtitre plate "U" form	no	281 µl	50	2.50	0.013
<b>900011</b>	microtitre plate "L" form	<b>STERILE R</b>	404 µl	50	2.33	0.013
<b>900011.1</b>	microtitre plate "L" form	no	404 µl	50	2.33	0.013
<b>900012</b>	microtitre plate "V" form	<b>STERILE R</b>	219 µl	50	2.33	0.013
<b>900012.1</b>	microtitre plate "V" form	no	219 µl	50	2.33	0.013
<b>900015</b>	lid for microtitre plate	<b>STERILE R</b>	–	50	1.28	0.016
<b>900015.1</b>	lid for microtitre plate	no	–	50	1.16	0.013

## Cell spreader. Sterile

Designed for surface spreading. Made of white polystyrene. **Sterilized by ethylene oxide. Total length:** 149 mm, **base length:** 40 mm. Base length allows spreading liquid samples over any type of Petri dish and avoids contact with the dish walls. The curved Spreader extremity and rounded corners avoid damaging media surface while spreading. The tip bent and rounded edges minimize the possibility of breakage of the solid medium during extension. It allows their use in places where sterilization before use is not possible (for instance when samples are collected far from the lab). Available in peel-pack containing 1 or 5 units, marked with code, expiry date, lot and sterilization method.

code	presentation	case quantity	case weight	case volume
200500.1	5 units peel-pack	1,000	3.32	0.018
200510.1	1 unit peel-pack	1,000	3.6	0.079

## Nichrome wire loops

Nichrome wire loops for microbiology. Comparing them to the traditional loops made of platinum and rhodium, the nickel and chrome alloy results much more competitive in terms of durability and price. Moreover, it offers a totally smooth surface, and rapid cooling after heat sterilisation.

### Non-calibrated loops (mod. A):

Non-calibrated nichrome loops, without holder, saving money and storage space. Supplied in groups of 25 units, in one tube, specifying code, description, and lot.

### Calibrated loops (mod. B):

Calibrated nichrome loops. Supplied individually in a capped tube, labeled with the code, description and lot.

### Non-calibrated loops with holder (mod. C):

Non-calibrated loop made of nichrome alloy. Light aluminum holder golden colour, partially protected by a transparent, insulating, non-skid plastic.

code	description	dimensions mm	case quantity	case weight	case volume
302762	Non-calibrated loop 2 mm Ø	75	25	0.025	0.000001
302764	Non-calibrated loop 4 mm Ø	75	25	0.30	0.0001
302771	Calibrated loop 1 µl	80	1	0.01	0.00004
302792	Non-calibrated loop (2 mm Ø) with holder	275	5	0.059	0.002
302794	Non-calibrated loop (4 mm Ø) with holder	275	5	0.057	0.002





## Streaking needles

Sterile polypropylene planting needle. Flexible, red. **Product sterilized by radiation.**

code	description	sterile	case quantity	case weight	case volume
668811	10 units peel-pack	STERILE R	6 x 1,000	7.78	0.030

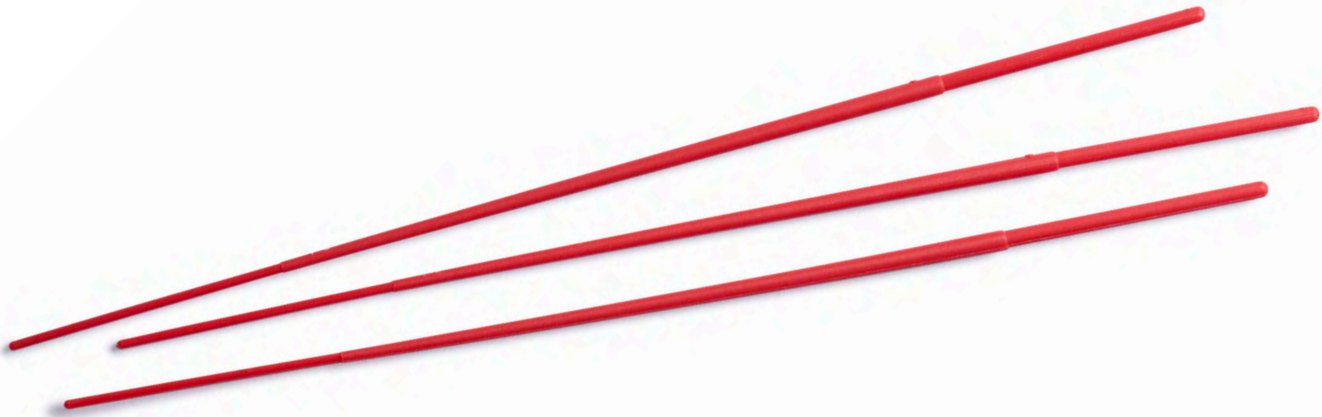

## Sterile calibrated loops

Inoculation loops used for collection and inoculation by streaking or puncturing method. Flexible loops made of HIPS material. Hexagonal shaft with stripes. They are ideal for inoculation in gel surface by streaking.

### Sterilized by radiation.

Two sizes available: 1 µl and 10 µl.

Not recommended for colony counting. Sterile inoculating loops.

Batch and expiry date printed on the bag.

The packaging offers a double closure with a zipper system that closes the coat once opened.

### Innoculation loops 1 µl:

Internal diameter : 0.75 ± 0.08 mm

Length : 196 mm

### Innoculation loops 10 µl:

Internal diameter : 4.1 ± 0.08 mm

Length : 200 mm

code	µl	presentation	colour	case quantity	case weight	case volume
302713	1	10 ud. zip lock	green	10 x 1,000	14.21	0.072
302733	1	20 ud. zip lock	green	10 x 1,000	12.75	0.072
302714	10	10 ud. zip lock	blue	10 x 1,000	14.3	0.072
302734	10	20 ud. zip lock	blue	10 x 1,000	12.8	0.070

## Sterile calibrated loops

Loops made of polystyrene, high robustness and adequate flexibility for comfortable and efficient use. **Sterilized by radiation.**  
 Double use loops: at one of the ends there is a loop for streaking in Petri dishes, using both qualitative and quantitative techniques. At the other end there is a fine tip specially designed for counting colonies. Available in 2 volumes: 1 and 10 µl. The green and blue colors are used to easily differentiate the 2 volumes in the laboratory. They offer great ergonomics and gripping thanks to its hexagonal design of each section which provide ease of orientation while using it. There are 3 presentations: individual pack, 10 and 20 units. All of them are supplied in a plastic packaging with easy opening. The loops are calibrated. **Deltalab** certifies the control of the dimensional accuracy of the diameter of the loop by means of specific gauge (**Calibration certificate available under request**).

Internal diameter 1 µl handle:  $1.42 \pm 0.05$  mm  
 Internal diameter 10 µl handle:  $3.98 \pm 0.05$  mm

code	µl	presentation	colour	case quantity	case weight	case volume
302743	1	individual flow pack	green	2 x 600	1.90	0.029
302744	1	peelable flow pack 10 units	green	2 x 1,400	2.95	0.029
302745	1	peelable flow pack 20 units	green	2 x 2,500	4.31	0.029
302753	10	individual flow pack	blue	2 x 600	1.90	0.029
302754	10	peelable flow pack 10 units	blue	2 x 1,400	3.00	0.029
302755	10	peelable flow pack 20 units	blue	2 x 2,500	4.34	0.029



## 12 ml screw cap tubes, round bottom

Made of **autoclavable (121 °C)** transparent polypropylene or polystyrene. Green cap made of high density polyethylene.

**Dimensions:** 15 x 102 mm. The external skirt allows the tubes to remain **free-standing**. Supplied screwed. Recommended volume: 12 ml. The sterile model (ethylene oxide) is supplied individually in flow-pack bag, with indication of batch, expiration date, etc.

According to the guidelines for sterile products. Resistance to centrifugation: **PS: 7,500 xg. PP: 15,000 xg.**

**Attention:** For autoclaving, the cap should be loose on the thread and not tightly fitted.



mod.	code	sterile	description	autoclavable	maximum volume ml	recommended volume ml	case quantity	case weight	case volume	cases pallet
1	301403	no	polystyrene		14.4	12	6 x 250	12.90	0.082	20
2	301402	STERILE EO	polystyrene individually wrapped		14.4	12	6 x 250	13.40	0.096	16
3	401402	STERILE EO	polypropylene individually wrapped	✓	14.2	12	6 x 250	12.03	0.096	16
4	401403	no	high transparency polypropylene	✓	14.2	12	6 x 250	11.11	0.082	20

### Dimensions (±0,09) :

code	external cap Ø mm A	external tube Ø mm B	internal tube Ø mm C	length with cap mm D	length without cap mm E
301402, 301403	20.9	16.3	14.4	103.9	102.5
401402, 401403	20.9	16.2	14.3	102.9	101.5

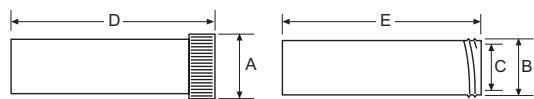

## Sterile culture tubes in polystyrene

Tubes supplied with either a two position ribbed polyethylene cap, which can be left loose for aerobic work or sealed for anaerobic cultures.

They are biologically inert, exempt from mold release agents, and withstand up to **1,400 xg** and at a temperature between **-190°C to 120°C**.

Packaged in self-standing resealable zip-lock bags of 125 units.

Graduation up to 4 ml and up to 14 ml. 1 ml graduation.



Loose position  
for aerobic work



PosSealed position for  
anaerobic cultures

code	dimensions mm	volume	case quantity	case weight	case volume
300807	12 x 75	5 ml	8 x 125	4.24	0.033
300808	17 x 100	14 ml	8 x 125	7.14	0.060

## 15 ml and 50 ml centrifugal tubes

Made of polypropylene, suitable for both clinical and research applications.

Latex and heavy metal free material. **Only non-sterile models are free of DNase, RNase, ATP, human DNA and endotoxins.**

High transparency of the material for a clear visualization during experiments specially for molecular biology.

Tube and cap designed with the system of flat threads for a complete leakproof.

Highly smooth hydrophobic surface for minimum disturbance during centrifugation.

Silk-screen black graduation in the tube and large white frosted portion for easy writing.

**Autoclavable at 121 °C.**

Centrifugation resistance: **14.000 xg**, except code **429931: 7.500 xg** and codes **429950, 429951: 3.500 xg**

It is recommended to use adapters to centrifuge and avoid malformations.

Available models: 15 ml non-skirted and 50 ml skirted and non-skirted.



code	description	presentation	sterile	case weight	case volume	cases pallet
<b>15 ml tubes</b>						
429940	non-skirted tube	500 tubes in bulk	no	500	4.50	0.034
429945	non-skirted tube	20 bag of 25 tubes	no	500	4.50	0.0281
429942	non-skirted tube	20 bag of 25 tubes	STERILE R	500	4.35	0.04
<b>50 ml tubes</b>						
429930	non-skirted tube	20 bag of 25 tubes	no	500	7.70	0.09
429931	non-skirted tube	20 bag of 25 tubes	STERILE R	500	7.44	0.108
429950	skirted tube	20 bag of 25 tubes	no	500	8.80	0.09
429951	skirted tube	20 bag of 25 tubes	STERILE R	500	8.80	0.108



## 15 ml conical tubes

Tubes made of transparent polypropylene, conical bottom, suitable for centrifugation tests in immunology, microbiology, etc. Continuous thread, external moulded graduations in 0,5 ml increments.

Wrinkled area (55 x 10 mm).

Blue cap in polyethylene with hermetic closure thanks to its internal elastic obturation.

Code **429910** is autoclavable (**121°C**) with the cap not being closed, just placed on the thread.

Autoclave not recommended for the codes **429920** and **429946**, as they have been **sterilized by radiation**.

Code **429920** is supplied sterile (100 units bags).

The bag specifies IVD, lot number, expiration date, etc.

Code **429946** is supplied sterile **in individual bags**. Resistance to centrifugation: **7,000 xg** (non sterile model) and **5,000 xg** (sterile models).

It is recommended to use adapters to centrifuge and avoid malformations.

Length (with cap): 120 mm. External mouth diameter: 17 mm. External cap diameter: 20,9 mm.



POLYPROPYLENE RACKS  
Pag. 225



code	sterile	autoclavable	case quantity	case weight	case volume	cases pallet
429910	no	✓	500	3.94	0.030	54
429920	STERILE R		5 x 100	3.90	0.029	54
429946	STERILE R		500	3.96	0.040	40



Please find racks for these tubes in chapter **Sample Storage**



## 50 ml conical tube

Tubes made of transparent polypropylene, conical bottom, suitable for centrifugation tests in immunology, microbiology, etc.

Perfect to analyse Koch bacillus. Continuous thread, external moulded graduations in 5 ml increments.

Blue cap in high density polyethylene with hermetical closure thanks to its internal elastic obturation.

Skirted and non skirted versions, **sterilized by radiation** and non sterilized versions. Sterile codes are either supplied in individual bags (codes **429926**, **429927**), in bags of 100 units (codes **429926.10**, **429927.10**), or in bags of 25 units (codes **429926.25**, **429927.25**) and resist up to **7,000 xg**.

Autoclave not recommended as they have been ionised.

Non sterile codes withstand up to **12,000 xg** and are autoclavable (**121 °C**) with the cap loose on the thread and not tightly fitted.

Every version is supplied capped, excepting code **429900SP**, which is supplied uncapped, with the cap in a separated bag.

You need to use the proper adapters to the tube of the code **429926** during the centrifugation to avoid malformations.

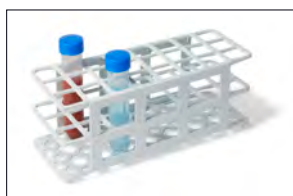

**POLYPROPYLENE RACKS:**

- 19568
- 19570



**METAL RACKS:**

- R-292 • R-293
- R-281 • R-282
- R-283



code	sterile	description	external cap Ø mm	internal tube Ø mm	external tube Ø mm	length with cap mm	case quantity	case weight	case volume	cases pallet
429900	no	non skirted	34.4	27.2	29.5	117.5	500	7.80	0.072	20
429900SP	no	non skirted, unscrewed cap	34.4	27.2	29.5	117.5	500	7.90	0.082	20
429901	no	skirted	34.4	27.2	29.5	117.5	500	8.50	0.082	20
429926	<b>STERILE R</b>	non skirted, individually wrapped	34.4	27.2	29.5	117.5	500	8.00	0.080	20
429926.25	<b>STERILE R</b>	non skirted, bag 25 units	34.4	27.2	29.5	117.5	20x25	8.30	0.082	20
429926.10	<b>STERILE R</b>	non skirted, bag 100 units	34.4	27.2	29.5	117.5	5x100	7.90	0.082	20
429927	<b>STERILE R</b>	skirted, individually wrapped	34.4	27.2	29.5	117.5	500	8.80	0.082	20
429927.25	<b>STERILE R</b>	skirted, bag 25 units	34.4	27.2	29.5	117.5	20x25	8.80	0.082	20
429927.10	<b>STERILE R</b>	skirted, bag 100 units	34.4	27.2	29.5	117.5	5x100	8.50	0.082	20



Please find racks for these tubes in chapter **Sample Storage**





### Pipetting bulb

This one-handed design is the simplest safety pipette filler to use available. Manufactured in natural orange rubber. Approx. drawn capacity: 25 ml. Single hand use, only two operating points. Evacuate via the automatic valve. Standard model, accommodates all pipettes. The inside bulb can be cleaned by removing the patented valve and rinsing out.



1. Evacuate the air by pressing the bulb, as the drawing indicates
2. Intake by pressing on point B (↑)
3. Drain the liquid by pressing on point A (↓)
4. Blow out the pipette by pressing as the drawing indicates (point C).

code	description	bag quantity	bag weight	bag volume
19200	pipetting bulb	1	0.05	0.0004

### Pipetting bulb

Made of rubber.  
Used to avoid mouth pipetting and contamination risk.  
Can be opened, cleaned and **autoclaved**.  
Ideal for Wintrobe and Westergren pipettes.



code	description	bag quantity	bag weight	bag volume
19201	red pipetting bulb	1	0.04	0.0002

### Pipette pumps

Several models for various pipette volumes.  
Designed for fast and efficient pipetting with simple, one handed operation.  
Pipettes fit smoothly into collar.  
Rotate the knurled thumb wheel on the side for precision filling or dispensing, and press the fast release lever for quick emptying.

Easy to use and easily disassembled for cleaning.  
Sizes are colour coded. Pipette pumps resist acids and alkalies.

Presentation in individual box.



code	description	colour	bag quantity	bag weight	bag volume
W-100	up to 2 ml	blue	1	0.06	0.0002
W-110	up to 10 ml	green	1	0.06	0.0002
W-120	up to 25 ml	red	1	0.06	0.0002

## Sterile serological pipettes

Made of glass polystyrene. Single use only.

Serological pipettes have an accuracy of +/- 2% at full scale.

### Sterilized by radiation.

Manufactured in one, two or three pieces depending on the volume.

They guarantee maximum precision without liquid retention at the welding level and offer a total dispensing. Pyrogenic, non-cytotoxic and non-hemolytic.

Volumes from 1 ml to 50 ml, identified with a polyolefin (does not contain synthetic fibers) white cotton and screen printed in colour according to volume.

The peel-pack of the models presented in this way is fiber-free and easy to open. Black graduations, bright and unalterable. Negative scale and double inverted scale (ascending and descending graduations).

### DNase and RNase free.

Manufactured in a room with controlled environment, class 100,000.

### BSE / TSE free.

This product does not contain latex.



Find trays, rotary stands and other products for pipettes in chapter **Safety and General Labware**



See our plastic Pasteur pipettes in chapter **Liquid Handling**



Please find racks for these pipettes in chapter **Sample Storage**



Three models of tips available:

A = TAPE END,

B = WIDE TIP,

C = OPEN TIP

(recommended for viscose samples).

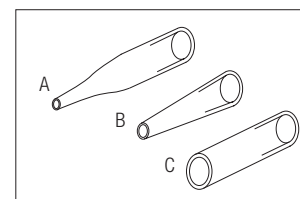

code	capacity ml	presentation	cotton colour	tip	graduation ml	negative graduation ml	total capacity ml	case quantity	case weight	case volume
900030.C	1	1 peel-pack	●	A	0/0.9	until -0.3	1.3	500	2.59	0.019
900031.C	1	bag of 25	●	A	0/0.9	until -0.3	1.3	40 x 25	4.02	0.019
900130.C	1	1 peel-pack	●	C	0/0.9	until -0.3	1.3	500	2.59	0.019
900032.C	2	1 peel-pack	●	A	0/1.8	until -0.6	2.6	500	3.74	0.019
900033.C	2	bag of 25	●	A	0/1.8	until -0.6	2.6	40 x 25	6.70	0.019
900034.C	5	1 peel-pack	●	A	0/4	until -3	8	200	2.42	0.014
900038.C	5	bag of 25	●	A	0/4	until -3	8	20 x 25	6.38	0.019
900144.C	5	1 peel-pack	●	B	0/4	until -3	8	200	2.42	0.014
900036.C	10	1 peel-pack	●	A	0/9	until -3	13	200	2.73	0.014
900037.C	10	bag of 25	●	A	0/9	until -3	13	16 x 25	5.5	0.019
900136.C	10	1 peel-pack	●	C	0/9	until -3	13	200	2.32	0.013
900146.C	10	1 peel-pack	●	B	0/9	until -3	13	200	3.82	0.014
900041.C	25	1 peel-pack	●	A	0/23	until -8	33	150	3.07	0.019
900043.C	50	1 peel-pack	●	A	0/46	until -10	60	100	2.54	0.019

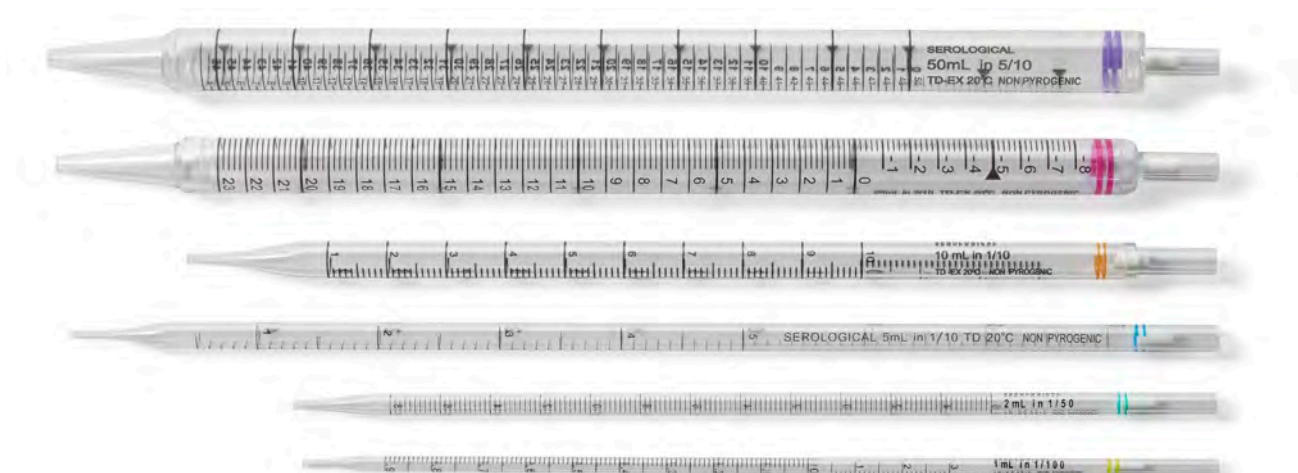



# New filtration range



Deltalab presents a new range of products for microfiltration, consisting of polycarbonate, cellulose nitrate and polyethersulfone membrane filters, as well as hydrophobic and hydrophilic cellulose acetate, nylon and PTFE syringe filters.

Membrane microfiltration is a technical process that allows solid particles to be retained from a fluid (liquid or gas) by passing through a microporous filter medium. Membrane filters, being surface filters with a very precise microporous structure, are used to retain and separate particles or microorganisms from a sample for analysis.

Particles larger than the absolute porosity of the filter are retained on its surface, while smaller particles pass through the filter unless other interactions retain them inside.

Microfiltration covers a smaller particle retention range than that of filtration with filter papers (depth filters). In addition, membrane filters are used in microbiological quality control procedures in various industries, such as food, beverage, pharmaceutical, cosmetics, water analysis, among others.

The DELTAGO range also includes syringe filters, designed to provide fast and efficient filtration of organic and aqueous solutions.



## Polycarbonate membranes

Polycarbonate membranes are manufactured from a high-quality polycarbonate film using track-etched technology. The resulting membrane is a thin, translucent, microporous polycarbonate film with a smooth, flat surface.

Its pore structure is uniform and very precise with a fairly homogeneous pore size distribution.

The surface makes them ideal for the identification of microorganisms using microscopy or binocular lenses.

It provides perfect sample control, capturing 100% of microorganisms larger than the pore size of the membrane.

Maximum working temperature: 140 °C.

Applications:

- Particle analysis.
- Epifluorescence microscopy.
- Fluid clarification.
- Cytology.
- Biological assays, cell biology and cell cultures.
- Removal of red blood cells from plasma.
- Water microbiology (Legionella analysis in drinking water according to ISO 11731).
- Environmental analysis (detection of AOX in water).



code	thickness	diameter	sterile	case quantity
100-2001	0.2 µm	47 mm	no	100

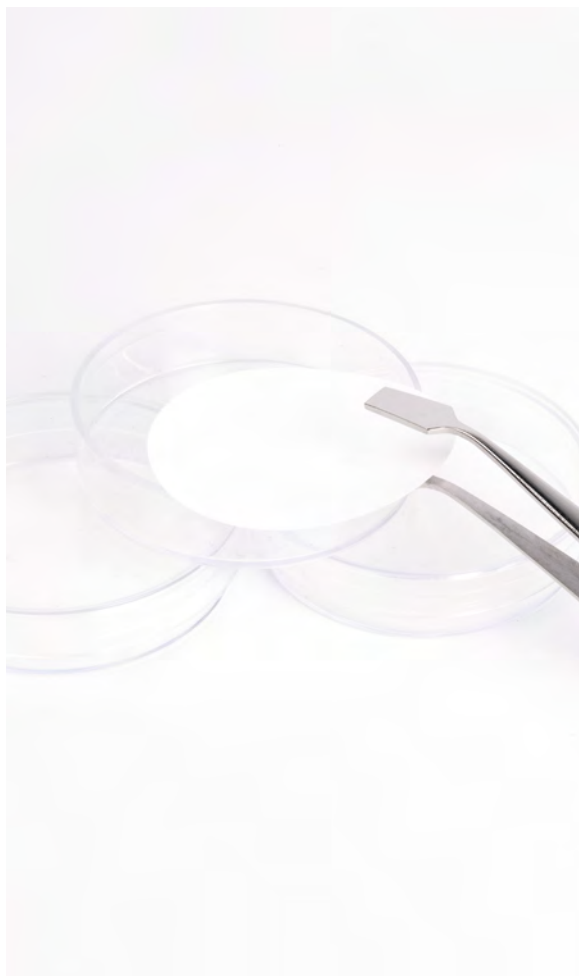

## Gridded cellulose nitrate filters

Gridded membranes made of mixed cellulose esters, sterile and individually packaged, for colony counting in routine microbiological quality control.

They are ready-to-use membranes and save preparation time.

The grid size is 3.1 x 3.1 mm.

Available in various colours to ensure the best contrast with the colonies.

Maximum working temperature: 130°C. Autoclavable and with high flow rate.

Applications:

- Clarification and sterilisation of aqueous solutions
- Microbiological analysis and colony counting
- Particle size analysis
- Pre-filtration and clarification of samples before further analysis
- Removal of particles in suspensions to determine the degree of impurity.



code	thickness	diameter	color	sterile	case quantity
100-1001	0.45 µm	47 mm	black	STERILE	100
100-1002	0.45 µm	47 mm	black	STERILE	1,000
100-1003	0.45 µm	47 mm	white	STERILE	100
100-1004	0.45 µm	47 mm	white	STERILE	1,000

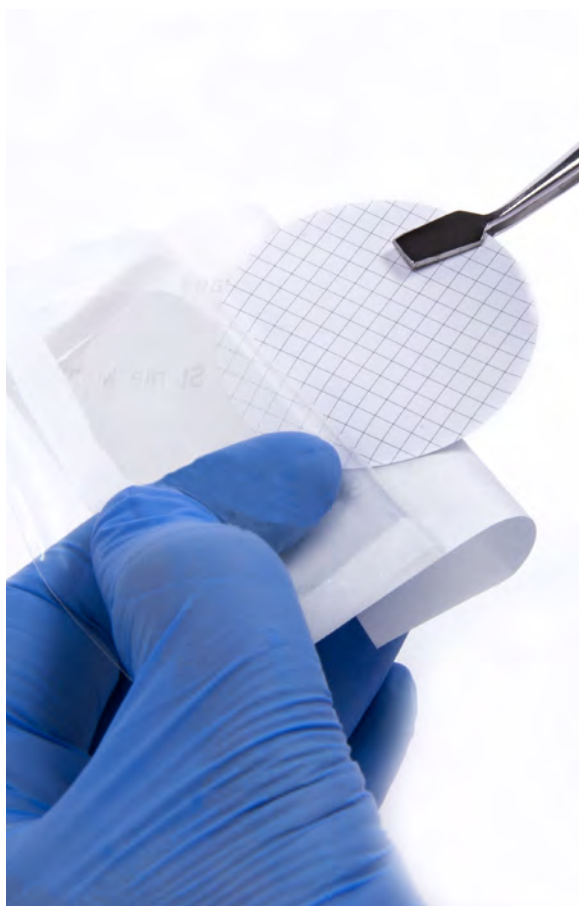

## PES membrane filters

This membrane is constructed from a temperature-resistant, acid- and base-resistant polyethersulfone polymer.

These membrane filters are recommended for biological applications in aqueous solutions and protein filtration.

They are designed to retain particles during general filtration. Their low protein adsorption and low drug binding characteristics make them ideal for use in life science applications.

Excellent flow rate, even with viscous liquids.

Sterilization: **autoclave at 121 °C**, with Y radiation or ethylene oxide

Applications:

- Filtration and sterilization of proteins and enzymes.
- Sterilization of biological fluids, serum and tissue culture media.
- Biological and clinical analysis.
- Filtration and sterilization of pharmaceutical solutions.
- Determination of the presence of Legionella for the concentration or elution method according to ISO 11731:2017.



code	thickness	diameter	sterile	case quantity
100-3001	0.2 µm	47 mm	STERILE	100
100-3002	0.2 µm	47 mm	STERILE	1,000



## Cellulose acetate syringe filters

Cellulose acetate syringe filters are manufactured for fast and efficient filtration of up to 100ml of liquid.

These ready-to-use units offer high flow rates at low inlet pressures.

Available in 5 pore sizes: hydrophilic membrane, low protein adsorption, high flow rate, high strength and stability, up to 100ml sample volume.

Applications:

- Preparation of biological fluid samples.
- Filtration of proteins and enzymes.
- Filtration of cell cultures.
- Clarification of aqueous and alcoholic solutions.



code	thickness	diameter	sterile	case quantity
100-4001	0.20 µm	25 mm	no	10
100-4004	0.45 µm	25 mm	no	50
100-4002	0.20 µm	25 mm	STERILE	50
100-4003	0.45 µm	25 mm	STERILE	100



## Nylon syringe filters

SNY syringe filters offer a polyamide 66 (Nylon) membrane in a polypropylene housing.

Due to their high chemical compatibility and physical strength, these syringe filters are recommended for filtering HPLC samples.

Hydrophilic membrane, wide range of chemical compatibility, autoclavable.

Applications:

- Filtration and clarification of samples.
- Sterilization of aqueous and dilute organic solvents.
- Preparation of HPLC samples.



code	thickness	diameter	sterile	case quantity
100-5001	0,20 µm	25 mm	no	100
100-5002	0,45 µm	25 mm	no	100



## Hydrophobic PTFE & Hydrophilic PTFE/L syringe filters

Hydrophobic PTFE/H syringe filters are indicated for cleaning small volume samples for HPLC or GC analysis, where maximum chemical resistance is required. Hydrophobic membrane, high chemical resistance to most solvents and acids, autoclavable.

Hydrophilic PTFE/L syringe filters are suitable for aqueous and aggressive organic solvent-based solutions and especially ideal for HPLC samples. The modified membrane exhibits broad chemical resistance and unsurpassed temperature stability to address aggressive sample cases or high temperature situations.



code	thickness	diameter	sterile	case quantity
<b>PTFE/H hidrofóbico:</b>				
100-6001	0.20 µm	13 mm	no	100
100-6003	0.20 µm	25 mm	no	100
100-6005	0.45 µm	13 mm	no	100
100-6007	0.45 µm	25 mm	no	100
<b>PTFE/L hidrofílico:</b>				
100-6002	0.20 µm	13 mm	no	100
100-6004	0.20 µm	25 mm	no	100
100-6006	0.45 µm	13 mm	no	100
100-6008	0.45 µm	25 mm	no	100



# Bottle for collecting water and microbiological analysis

The container contains 24 mg/l of sodium thiosulfate, which neutralizes the bactericidal effect of chlorine during sample transport.

The container is graduated up to 100 ml and includes molded graduations and a label with space to note the sample identification.

This container is made of high transparency polypropylene and has a red, high-density polyethylene screw cap with a discontinuous thread and ribbed for easy handling. The closure is airtight and highly secure thanks to the internal shutter incorporated in the cap.

The product is developed following the ISO 5667-3:2012 Water quality: sampling standard and complies with the European Directive 2020/2184/CE and subsequent amendments.

Its storage does not require special environmental conditions, although it is preferable to avoid sudden temperature changes.

This container allows the user to comply with the European standard UNE10030/2023 for Legionella control.



## 120 ml bottle with thiosulfate for water analysis

The bottle contains 24 mg/l of sodium thiosulfate, which neutralises the bactericidal effect of chlorine during sample transport.

The container is graduated up to 100 ml and includes a moulded graduation and a label with space to write down the sample identification.

This bottle is made of highly transparent polypropylene and has a cap with a discontinuous, red, ribbed high-density polyethylene thread for easy handling. The closure is airtight and highly secure thanks to the internal shutter incorporated in the cap.

Product developed in accordance with ISO 5667-3:2012 Water quality: sampling, and complies with European Directive 2020/2184/EC and subsequent amendments.

Its storage does not require special environmental conditions, although it is preferable to avoid sudden changes in temperature.



code	description	sterile	capacity ml	case quantity	case weight	case volume	cases pallet
409766	bottle with thiosulfate	STERILE R	120	350	6.30	0.140	16

We can supply bottles with different concentrations of thiosulfate according to the regulations applied in each country. For bottles of other volumes, please contact our sales department.

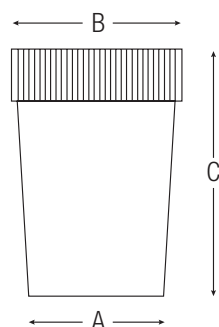

**Dimensions:**  
 Outer diameter (A): 48.3 mm  
 Outer diameter with plug (B): 62.1 mm  
 Total length with plug (C): 74.3 mm



## Sterile jars for water sampling

Transparent squared jars made of PET.

Wide mouth and grips at two sides, easing the sample collection.

Red cap made of polypropylene with internal liner made of polyan with a label that performs as tamper evident.

**Sterilized by radiation.** Each bottle is labelled specifying description, code, lot, and expiry date.

Internal mouth diameter: 55 mm

Jar weight (gr):

500 ml jar: 44 g - 1,000 ml jar: 65 g

**Available with or without sodium thiosulfate.**

**With liquid sodium thiosulfate (24 mg/l):** Ideal to analyze water meant for human consumption, swimming pools, and any other water where chlorine may modify the composition of the sample while being transported.

**Empty, without thiosulfate:** Ideal to sample unchlorinated water for microbiological analysis, as well as for other sampling requiring sterile bottles.



code	sterile	capacity ml	case quantity	case weight	case volume	cases per pallet
jars with thiosulfate						
282340	STERILE R	500	44	2.68	0.036	40
282341	STERILE R	1,000	48	4.30	0.076	20
jars without thiosulfate						
282350	STERILE R	500	44	2.68	0.036	40
282351	STERILE R	1,000	48	4.30	0.076	20

We can supply any other concentration according to each country's standards.

We can also dose thiosulfate in other jars from our catalogue.

Optionally presented in individual bags if requested.

For different presentations, please contact with sales department.



See industrial funnels on chapter  
Laboratory and industrial packaging

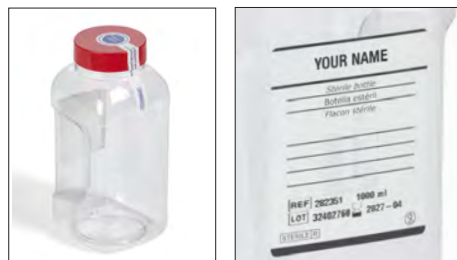

## Sterile bottles for water sampling

Rectangular body and cap made of polyethylene. The minor sides are gripped for a better handling. The larger sides are flat for labelling. Tamper evident red cap with an internal joint. Hermetical closure.

### Sterilized by radiation.

Each bottle is labelled specifying description, code, lot, and expiry date.

### Dimensions:

500 ml bottle: 83 x 65 x 135 mm - 1,000 ml bottle: 83 x 65 x 235 mm.

Internal mouth diameter: 28 mm.

Unitary weight (empty bottle):

500 ml bottle: 40 g - 1,000 ml bottle: 61 g.

### Available with or without sodium thiosulfate.

**Bottles with liquid sodium thiosulfate (24 mg/l):** Ideal to analyse water meant for human consumption, swimming pools, and any other water where chlorine may modify the composition of the sample while being transported.

**Sterile bottles:** Ideal to sample unchlorinated water for microbiological analysis, as well as for other sampling requiring sterile bottles.



code	description	sterile	capacity ml	case quantity	case weight	case volume	cases per pallet
282320	bottle with thiosulfate	STERILE R	500	24	1.35	0.025	48
282321	bottle with thiosulfate	STERILE R	1,000	20	1.67	0.033	42
282323	bottle with thiosulfate	STERILE R	500	111	6.00	0.110	16
282323.BU	bottle with thiosulfate, individually wrapped	STERILE R	500	111	6.04	0.110	16
282324	bottle with thiosulfate	STERILE R	1,000	68	5.15	0.100	16
282324.BU	bottle with thiosulfate, individually wrapped	STERILE R	1,000	68	5.41	0.110	16
282330	bottle sterile	STERILE R	500	24	1.36	0.025	48
282331	bottle sterile	STERILE R	1,000	20	1.37	0.033	42
282333	bottle sterile	STERILE R	500	111	5.92	0.110	16
282334	bottle sterile	STERILE R	1,000	68	5.15	0.110	16

We can supply any other concentration according to each country's standards.

For other volume bottles, please contact our sales department.

Optionally presented in individual bags if requested.







### Whirl-Pak® bags with sodium thiosulfate

Bags used for collecting samples of drinking water and treated waters of swimming pools, sewage, etc. These bags tend to stand on their own, they are pre-sterilized, they are unbreakable, compact, with matte band for identification and closure. It is totally waterproof. They contain 10mg sodium thiosulfate tablets inside for each 100ml of water.



code	description	capacity ml	dimen. cm	thickness microns	case quantity	case weight	case volume
292601	Stand-up bag with thiosulfate	100	7.5 x 18.5	63.5	100	0.45	0.002
292602	Stand-up bag with thiosulfate	300	11.5 x 23	76.2	100	0.68	0.003
292605	Stand-up bag with thiosulfate	500	15 x 23	76.2	100	1.14	0.010
292606	Stand-up bag with thiosulfate	1,000	15 x 38	101.6	100	1.7	0.015

### Long-handled dippers

Polypropylene cup and polyethylene handle. For convenient sampling from tanks, vats, streams, ponds, lakes, etc. These dippers are light, easy to use and portable. The polypropylene cups have threaded fittings that screw onto the handle. Two pouring spouts on the 500 ml dipper make it useful for left or right handed people to pour from either side.

The end of the handle has a hook for hanging.

Autoclavable container (up to 121°C).



code	description	quantity	weight	volume
19575	91 cm handle, 500 ml container	1	0.30	0.009
19576	183 cm handle, 500 ml container	1	0.76	0.020
19577	container 500 ml (fits either handle)	1	0.30	0.005

Please ask the sales department for other lengths.

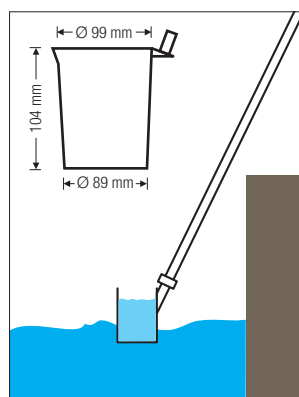

### Sterile homogeniser lateral filter bag

Filter bag suitable for PCR and small volumes, it can be used with very short pipettes.

The unique and patented Pull-Up system allows to pinch the bag and pull up the filtered liquid for easy pipetting.

Nonwoven side filter having a porosity of 50 microns, rigid and transparent. The filtration is performed during homogenization, it is not necessary to wait for the sedimentation of particles.

Compatible with any lab blender.

**Sterile by radiation.**

code	packaging	case quantity	case weight	case volume
983045	homogeniser lateral filter bag 400 ml	10x25	2.72	0.010



### Sterile homogeniser full size filter bag

Bag made of transparent polyethylene (PE) divided in two parts by a filter: **15005**: the filter is integrated into the bag.

**122000**: joined to the bag by a point in the upper part of the sheet.

The sample is inserted into one of the compartments and, after being homogenised and filtered, the solid particles remain in the initial compartment, while the liquid ones pass to the other compartment and can be extracted with a pipette without any risk of obstruction.



code	packaging	sterile	case quantity	case weight	case volume
15005	bag 180x310 mm	STERILE R	10 x 50	6.50	0.047
122000	bag 190x300 mm	STERILE R	20 x 25	5.92	0.020

code	filter	recommended working volume (ml)	maximum capacity (ml)	bag graduation
15005	286 holes/cm <sup>2</sup>	50-400	1.600	YES (each 100 ml)
122000	280 microns	1.600	1.600	NO



15005



122000

### Tissue grinders-homogenisers

Borosilicate glass vessels and serrated plunger. Tips: head made of TEFLON. Shaft made of stainless steel. Fully **autoclavable**. The distance between the glass and the plunger is  $\pm 200 \mu\text{m}$ .



**Glass vessels:**

code	volume ml	body Ø mm	height mm	case quantity	case weight	case volume
196102	2	8	120	1	0.01	0.001
196105	5	12	132	1	0.01	0.001
196110	10	16	150	1	0.02	0.001
196115	15	19	155	1	0.03	0.001

**Plunger-serrated tips:**

code	for tube of mm	height mm	case quantity	case weight	case volume
196302	2	230	1	0.06	0.001
196305	5	235	1	0.06	0.001
196310	10	270	1	0.06	0.001
196315	15	270	1	0.02	0.001



## Sterile Whirl-Pak® blender bags with and without filter

Bags made of a low density polyethylene blend, resulting in an **extra-resistant and transparent bag**. Leakproof closure with several metallic rounded sticks.

Codes **200373**, **200374** and **200376** feature a **filter layer** of finely **perforated polyethylene**, to separate the liquid and solids. This allows the **easy pipetting of the sample**. There are 6.45 holes per cm<sup>2</sup>, each one measuring 330 microns diameter. Bags with a **one-piece seam**, avoiding the possible risks of the loss of the corners bags. They feature a write-on strip (excluding codes **200342** y **200343**). **Ethylene Oxide sterilized**. Made with materials suitable for food or food industry.



mod.	code	description	food use	capacity ml	dimensions cm	thickness microns	case quantity	case weight	case volume
1	<b>200342</b>	standard bag	✓	390	13 x 19	76	500	2.50	0.0170
1	<b>200343</b>	standard bag	✓	720	15 x 23	102	500	3.88	0.0168
2	<b>200351</b>	bag with write-on strip	✓	1,650	19 x 30	102	500	5.66	0.0182
3	<b>200373</b>	bag with filter and write-on strip	✓	720	15 x 23	102	250	1.98	0.0166
3	<b>200376</b>	bag with filter and write-on strip	✓	1,650	19 x 30	102	250	3.88	0.0180
3	<b>200374</b>	bag with filter and write-on strip	✓	2,041	19 x 38	102	250	4.28	0.0170

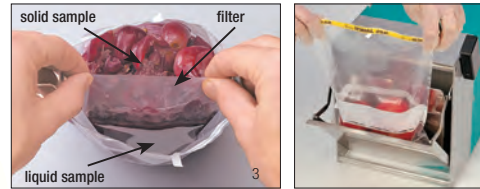

## Sterile bags for STOMACHER® blenders

Made of polyethylene. Thickness: gauge 300. Ideal for mixing and blending bacterial samples or when collecting toxic substances from food, fabrics, etc.

**Irradiation sterilized.** Supplied in bags of 25 units.

Code **15006** is a stainless steel rack for 14 bags. Side handles incorporated.

To close bags. They may be used with the rack **15006**.

Made of a blue tubular piece (230 mm) and a white clip (197 mm) which tightens the bag around the blue tube.

Code **983047** is a clip to close and adjust bags onto the rack.

Also available non sterile versions. Please ask for the minimum order quantity and delivery time. Add an "S" at the end of the code.

mod.	code	description	capacity ml	case quantity	case weight	case volume
1	<b>15001</b>	bag 100 x 155 mm	80	100 x 25	5.00	0.014
2	<b>15003</b>	bag 180 x 300 mm	400	20 x 25	4.20	0.014
3	<b>15004</b>	bag 380 x 580 mm	3,500	200	6.12	0.013
4	<b>15006</b>	rack 390 x 200 x 240 mm	-	1	1.77	0.039
5	<b>983047</b>	clips*	-	200	4.30	0.04

\* Tubular piece: 230mm | Clip: 197 mm | Diameter: 10mm

## Whirl-Pak® surface sampling bags

New Whirl-Pak bags with spoon, hydrated sponge with sample collection medium. The buffered medium of the 200381 model contains monopotassium phosphate, sodium thiosulfate and aryl sulphonate complex.

### Code 200381

Cellulose sponge, hydrated with 10 ml of neutralizing buffer. The buffer will neutralize surface sanitizers, including quaternary ammonium compounds, phenolics, iodine preps, chlorine preps, mercurials, formaldehyde, and glutaraldehyde. Diluent has a 24-month shelf life from the date of manufacture. Neutralizing buffer contains monopotassium phosphate, sodium thiosulfate, and aryl sulfonate complex.

### Code 200382

532 ml write-on bag contains a sterile, disposable polystyrene plastic spoon of approximately 1 teaspoon capacity.



mod.	code	presentation	sterile	capacity ml	dimensions cm	thickness microns	case quantity	case weight	case volume
1	200381	Bag with hydrated sponge with medium	STERILE EO	532	11.5 x 23	63.5	100	2.5	0.019
2	200382	Bag with spoon	STERILE EO	532	11.5 x 23	63.5	100	1.02	0.007

## Meat sampling kit

Designed according to the international standard **ISO 17604**, which is taken as reference on European Directives and Rules about microbiology of food and animal feeding stuff – carcass sampling for microbiological analysis.

Kit 200393.VSP consists of:

- Bottle with 25 ml of sterile buffered peptone water
- Abrasive sponge presented in a sterile bag

The template is sold separately (code 200393P).

Expiry date: 16 months.

code	packaging	sterile	case quantity	case weight	case volume
<b>NEW</b> 200393.VSP	carcass sampling kit with sponge	STERILE R	10	3.00	0.010
200393P	template meat sampling	STERILE R	20	0.75	0.0051

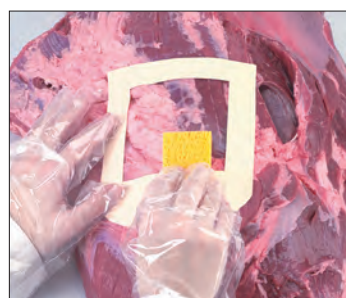



# 02. CELL CULTURE. MOLECULAR BIOLOGY





## Cell and tissue culture multiwell plates

Ideal for cell growth and cell yields on multiple, comparative and other analysis. Single position lid reduces the risks of cross-contamination and handling mistakes. Wells are labelled with alphanumeric codes for easy identification. Suitable for all common instruments and automation.

**Surface treated.**

**Lid included. Individually packaged.**



code	n° of wells	surface cm <sup>2</sup>	sterile	case quantity	case weight	case volume
D200001	6	9.6	STERILE R	100	6.55	0.075
D200002	12	3.85	STERILE R	100	8.80	0.075
D200003	24	1.93	STERILE R	100	8.55	0.075
D200004	48	0.83	STERILE R	100	8.45	0.075
D200005	96	0.33	STERILE R	100	8.35	0.075
D200006	96	0.58	STERILE R	100	8.56	0.062

## Cell and tissue culture flasks

Cell and tissue culture flasks are perfect for cell growth with optimal performance in cases of small to medium initial sample volumes. Available as surface treated and untreated surfaces. Flask surface is flat and free of streaks to maximize the usable growth area. The innovative angled neck design provides good access for pipettes and scrapers. Both sides of the flask have engraved graduations, and **all references can be vented or non-vented, depending on how the cap is closed.** There are models with and without a filter in the cap.

Strict integrity tested. Packaged in packs of 10 units.

**Sterilized by radiation. Non-pyrogenic. DNase/RNase-free.**



	lid with filter	lid without filter	description	max. vol. ml	surface cm <sup>2</sup>	sterile	case quantity	case weight	case volume
suspension	D200020	D200010	non treated	25	12.5	STERILE R	200	3.00	0.030
	D200021	D200011	non treated	50	25	STERILE R	200	5.40	0.040
	D200022	D200012	treated	25	12.5	STERILE R	200	3.00	0.030
adhesion	D200023	D200013	treated	50	25	STERILE R	200	5.40	0.040
	D200024	D200014	treated	250	75	STERILE R	200	7.40	0.076
	D200025	D200015	treated	600	182	STERILE R	200	6.30	0.060



## Cell and tissue culture dishes

Cell and tissue culture dishes are ideal containers for cell growth and yields point to a small and medium volume of input, and are also useful in sample separation, pretreatment, storage, etc.

Surface treated. The uniform thickness of the flat bottom wall guarantees a bottom without distortion.

**Sterilized by radiation. Non-pyrogenic. DNase/RNase-free.**



	code	diameter mm	cell growth area cm <sup>2</sup>	sterile	case quantity	case weight	case volume
	P35 D200035	33.2	8.5	STERILE R	96 x 10	5.00	0.028
	P60 D200060	53.3	21.2	STERILE R	60 x 10	10.50	0.050
	P100 D200100	88.5	60.8	STERILE R	30 x 10	10.08	0.076
	P150 D200150	136.1	143.0	STERILE R	12 x 10	8.20	0.082



## Cell scrapers (normal and rotatable)

Normal version and rotating version. Material: blades/PE, handle/ABS. **Special developed to make the process of scraping off and collecting cells more easier and effective.**

Free rotating blade to twist to the desired direction. Total access to all corners. Small raised knobs on the handle

**Individually packaged. Sterilized by radiation. Non-pyrogenic. DNase/RNase-free.**



code	description	Length cm	sterile	case quantity	case weight	case volume
D200034	Cell scraper	25	STERILE R	100	1.3	0.01
D200030	Rotable cell scraper	30	STERILE R	150	2.5	0.019



## Cell strainer

Cell strainers are manufactured from a strong nylon mesh with evenly spaced mesh pores and gamma resistant. These cell strainers are sterile, rapid, easy-to-use devices for isolating primary cells to consistently obtain a uniform single-cell suspension from tissues. Protect your valuable flow cytometry and cell sorting instrumentation by reliably removing clumps and debris from cell suspensions and clinical samples prior to analysis. Improved uniformity of single cell suspensions. Made of a strong nylon mesh with evenly spaced mesh pores. The extended lip on the strainer enables aseptic handling with forceps

Ready-to-use. **Individually packaged.**

**Sterilized by radiation. Non-pyrogenic. DNase/RNase-free.**



code	capacity (µm)	colour	sterile	case quantity	case weight	case volume
D200031	40	blue	STERILE R	200	1.32	0.018
D200032	70	natural	STERILE R	200	1.32	0.018
D200033	100	yellow	STERILE R	200	1.32	0.018







## Vacuum filtration

Vacuum filters are very useful in large volume samples separation and purification. Available with 5 membrane sorts of PVDF and PES. 2 membrane pore sizes of 0.22µm and 0.45µm. 4 volumes size of 150, 250, 500 and 1000ml.

Individually packaged.  
Sterilized by radiation.  
Non pyrogenic. **DNase/RNase-free.**



code	funnel capacity	pore size (µm)	membrane	diameter (mm)	sterile	case quantity	case weight	case volume
D300002	150	0.22	PES	50	STERILE R	12 x 1	3.65	0.066
D300003	250	0.22	PES	50	STERILE R	12 x 1	3.65	0.066
D300004	500	0.22	PES	75	STERILE R	12 x 1	3.65	0.066
D300001	500	0.45	PVDF	75	STERILE R	12 x 1	3.65	0.066
D300000	1,000	0.22	PVDF	91	STERILE R	12 x 1	3.65	0.066
D300005	1,000	0.22	PES	91	STERILE R	12 x 1	3.65	0.066

## 15 ml and 50 ml centrifugation tubes

Made of polypropylene, suitable for both clinical and research applications. **Material free of latex and heavy metals.** Only non-sterile models the material is free from DNase, RNase and pyrogens. Centrifugation resistance: **14.000 xg**, except code **429931: 7.500 xg** and codes **429950, 429951: 3.500 xg**. See more technical information on page 41.

**DNase/RNase-free.**



code	description	presentation	sterile	case weight	case volume	cases pallet
<b>15 ml tubes</b>						
429940	non-skirted tube	500 tubes in bulk	no	500	4.50	0.034
429945	non-skirted tube	20 bags of 25 tubes	no	500	4.50	0.0281
429942	non-skirted tube	20 bags of 25 tubes	STERILE R	500	4.35	0.04
<b>50 ml tubes</b>						
429930	non-skirted tube	20 bags of 25 tubes	no	500	7.70	0.09
429931	non-skirted tube	20 bags of 25 tubes	STERILE R	500	7.44	0.108
429950	skirted tube	20 bags of 25 tubes	no	500	8.80	0.09
429951	skirted tube	20 bags of 25 tubes	STERILE R	500	8.80	0.108



## Sterile culture tubes in polystyrene

Tubes supplied with either a two position ribbed polyethylene cap, which can be left loose for aerobic work or sealed for anaerobic cultures. They are biologically inert, exempt from mold release agents, and withstand up to **1,400 xg** and at a temperature between **-190°C to 120°C**. Packaged in self-standing resealable zip-lock bags of 125 units.



Loose position for aerobic work



PosSealed position for anaerobic cultures

code	dimensions mm	volume	case quantity	case weight	case volume
300807	12 x 75	5ml	8 x 125	4.24	0.033
300808	17 x 100	14ml	8 x 125	7.14	0.060



## Sterile serological pipettes

Made of glass polystyrene. Single use only. Serological pipettes have an accuracy of +/- 2% at full scale. **Sterilized by radiation**. Manufactured in one, two or three pieces depending on the volume. **DNase and RNase free. BSE / TSE free.** Pyrogenic, non-cytotoxic and non-hemolytic. See more technical information on page 45.

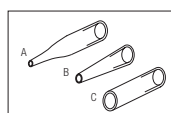

Three models of tips available:  
A = TAPE END  
B = WIDE TIP  
C = OPEN TIP (recommended for viscose samples).



code	capacity ml	presentation	cotton colour	tip	graduation ml	negative graduation ml	total capacity ml	case quantity	case weight	case volume
900030.C	1	1 peel-pack	Yellow	A	0/0.9	until -0.3	1.3	500	2.59	0.019
900031.C	1	bag of 25	Yellow	A	0/0.9	until -0.3	1.3	40 x 25	4.02	0.019
900130.C	1	1 peel-pack	Yellow	C	0/0.9	until -0.3	1.3	500	2.59	0.019
900032.C	2	1 peel-pack	Green	A	0/1.8	until -0.6	2.6	500	3.74	0.019
900033.C	2	bag of 25	Green	A	0/1.8	until -0.6	2.6	40 x 25	6.70	0.019
900034.C	5	1 peel-pack	Blue	A	0/4	until -3	8	200	2.42	0.014
900038.C	5	bag of 25	Blue	A	0/4	until -3	8	20 x 25	6.38	0.019
900144.C	5	1 peel-pack	Blue	B	0/4	until -3	8	200	2.42	0.014
900036.C	10	1 peel-pack	Orange	A	0/9	until -3	13	200	2.73	0.014
900037.C	10	bag of 25	Orange	A	0/9	until -3	13	16 x 25	5.5	0.019
900136.C	10	1 peel-pack	Orange	C	0/9	until -3	13	200	2.32	0.013
900146.C	10	1 peel-pack	Orange	B	0/9	until -3	13	200	3.82	0.014
900041.C	25	1 peel-pack	Pink	A	0/23	until -8	33	150	3.07	0.019
900043.C	50	1 peel-pack	Purple	A	0/46	until -10	60	100	2.54	0.019

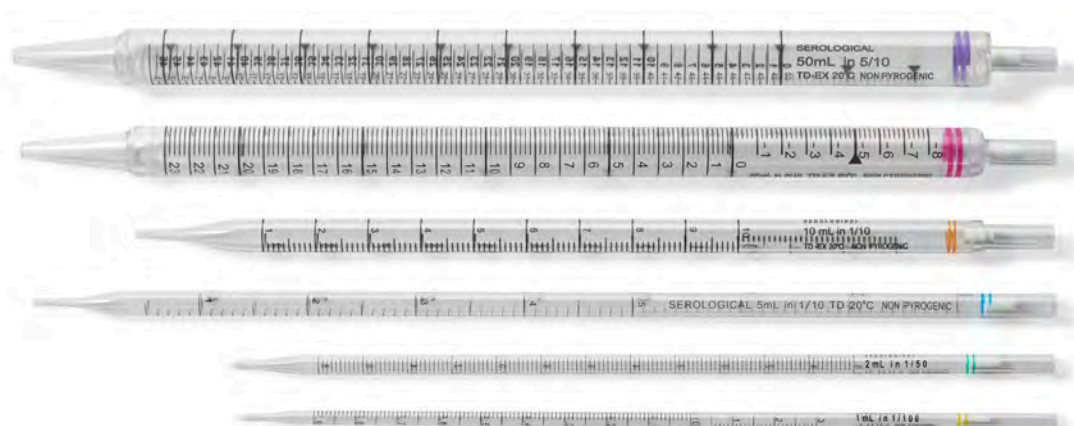



## Screw thread microtubes

Made of **autoclavable** polypropylene, they can be used at extreme temperatures from **-190 °C to +121 °C**. Two versions available: in transparent polypropylene, or opaque brown (**UV resistant**, designed to be used with light sensitive samples). **Certified RNase, DNase and pyrogen free**. Tubes and caps can be centrifuged at **17,000 xg**. Caps are supplied separately, see below.

**Dimensions:** 11 x 44 mm.



mod.	code	volume ml	skirt	case quantity	case weight	case volume
<b>Transparent polypropylene</b>						
1	<b>409110.1</b>	0.5	yes	1,000	1.47	0.010
2	<b>409110.2</b>	1.5	yes	1,000	1.45	0.009
3	<b>409110.3</b>	1.5	no	1,000	1.13	0.007
4	<b>409110.4</b>	2.0	yes	1,000	1.30	0.013
<b>Brown polypropylene</b>						
5	<b>409113.1</b>	0.5	yes	1,000	1.54	0.009
6	<b>409113.2</b>	1.5	yes	1,000	1.34	0.009
7	<b>409113.3</b>	1.5	no	1,000	1.14	0.007
8	<b>409113.4</b>	2	yes	1,000	1.34	0.009

## Caps for screw thread microtubes

Made of polypropylene.

Caps are available either with an attachment loop or without loop. Both models have a sealing O-ring (red) of silicone to ensure a positive leakproof seal.

**Cap dimensions:** 13 x 8 mm.



mod.	code	description	case quantity	case weight	case volume
<b>Transparent polypropylene</b>					
1	<b>409007.N</b>	cap with loop	1,000	0.41	0.003
2	<b>409008.N</b>	cap without loop	1,000	0.40	0.002
<b>Brown polypropylene</b>					
3	<b>409007.M</b>	brown cap with loop	1,000	0.45	0.003
4	<b>409008.M</b>	brown cap without loop	1,000	0.55	0.010

## Screw cap microtubes, with cap. Sterile

Tubes and caps in medical grade, transparent polypropylene.

The cap embodies a non-reactive gas-propylene o-ring.

Suitable for **autoclave, liquid nitrogen (gaz) and boiling processes**.

Perfect for long term storage. Withstand temperatures from **-190 °C**.

**DNase, RNase, DNA, and PCR inhibitors free.**

Centrifugation Resistance: **20,000 xg**.

Graduated models feature a frosted area for writing.

Microtubes are supplied capped, in bags of 50 units.

**Dimensions:** 44.45 x 12.95 mm



code	volume ml	skirted	sterile	graduation	case quantity	case weight	case volume
<b>409115/4</b>	0.5 ml	yes	<b>STERILE R</b>	✗	50 x 50	5.90	0.030
<b>409115/2</b>	1.5 ml	no	<b>STERILE R</b>	✓	50 x 50	5.90	0.030
<b>409115/6</b>	2 ml	yes	<b>STERILE R</b>	✓	50 x 50	5.90	0.030
<b>409115/3</b>	2 ml	no	<b>STERILE R</b>	✓	50 x 50	5.90	0.030



## Screw thread microtubes

Made of transparent polypropylene. Suitable for use in liquid nitrogen, **autoclave** and for boiling applications, and can be used at temperatures down to **-190 °C**. Products ideal for long term sample storage. **Certified RNase, DNase and PCR inhibitors free**. Withstand centrifugation at **20,000 xg**. The codes **409111/4**, **409111/5** and **409111/6**, with external moulded slots for better handling with gloves. **Dimensions:** 10.3 x 44.5 mm (except code **409111/2**: 10.3 x 43.6 mm). Caps are supplied separately, see below.

mod.	code	description	skirted	graduation	case quantity	case weight	case volume
1	409111/4	0.5 ml	yes	✗	500	0.78	0.005
2	409111/2	1.5 ml	no	✓	500	0.61	0.005
3	409111/5	1.5 ml	yes	✗	500	0.73	0.005
4	409111/3	2.0 ml	no	✓	500	0.71	0.005
5	409111/6	2.0 ml	yes	✗	500	0.76	0.005
6	409111/7	2.0 ml	yes	✓	500	0.73	0.005

## Caps for screw thread microtubes

Made of medical grade polypropylene. Featuring an internal O-ring to ensure leakproof seal. **Certified RNase, DNase and PCR inhibitors free**. **Dimensions** 13.0 x 6.0 mm.



code	colour	case quantity	case weight	case volume
409112/0	natural	500	0.019	0.0009
409112/1	blue	500	0.019	0.0009
409112/2	green	500	0.019	0.0009
409112/4	red	500	0.019	0.0009
409112/6	yellow	500	0.019	0.0009



## Screw thread tamper evident microtubes

Microtubes and caps are made of autoclavable ultra clear polypropylene. Ribbed cap with internal silicone O-ring for a positive **leakproof seal**. Super fast ¼ turn thread design. **Tamper evident** seal that proves if microtube has been opened. They can be used at extreme temperatures from **-196 °C** to **121 °C**.

**Rnase, Dnase and Pyrogen free.**

Resistance to centrifugation: **17,000 xg**.

**Microtube dimensions:** 11 x 44 mm.

**Cap dimensions (with tamper-evident ring):** 15 x 9 mm



1. Screw cap until locking ring clicks over serrated tube neck.
2. Contents are now protected until cap is removed and tamper-evident ring is detached.



mod.	code	volume ml	case quantity	case weight	case volume
1	409110.4T	2	1.000	2.06	0.013
2	409110.2T	1.5	1.000	2.06	0.013

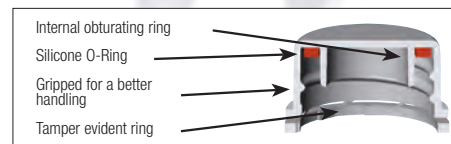



### Human DNase, RNase and DNA free certified swabs, sterile

**Human DNA free Certified.** The swab is supplied in a polypropylene tube, which protects the sample up to the laboratory prior to its analysis.

The stick of the swab is made of polystyrene while the head is produced with viscose or polyester according to the code.

The tube is labeled indicating code, description, lot, expiry date and providing an identifying area to note down collection details (site, date, etc.).

Moreover, the label seals the tube with the cap of the swab, acting like a tamper evident system.

Sterilized by ethylene oxyde.



code	description	selling unit	case quantity	case weight	case volume
300252DNA	polystyrene + viscose	500	4 x 500	14.20	0.070

Expiry date: 48 months.

### Cryovials with external threads

Non skirted versions withstand centrifugation up to **14,000 xg**.



code	volume ml	skirt	dimensions mm*	case quantity	case weight	case volume
409105.1	1.2	yes	12.5 x 42	10 x 100	2.50	0.014
409103.1	2.0	no	12.5 x 47	10 x 100	2.70	0.017
409106.1	2.0	yes	12.5 x 49	10 x 100	2.68	0.015
409107	3.0	yes	12.5 x 71	10 x 100	3.88	0.023
409108	4.0	yes	12.5 x 77	10 x 100	3.90	0.028
409109	5.0	yes	12.5 x 92	10 x 100	4.60	0.023
401410	10.0	yes	17.0 x 84	10 x 50	2.80	0.020

\* Capped.

### Cryovials with internal threads

Non skirted versions withstand centrifugation up to **14,000 xg**.



See Colour coded inserts at page 174



code	volume ml	skirt	dimensions mm*	case quantity	case weight	case volume
409001	1.2	yes	12.5 x 41	10 x 100	1.94	0.015
409002	2.0	no	12.5 x 48	10 x 100	2.22	0.016
409002.1	2.0	yes	12.5 x 49	10 x 100	2.24	0.015
409003	4.0	no	12.5 x 70	10 x 100	3.79	0.028
409003.1	4.0	yes	12.5 x 72	10 x 100	3.90	0.028
409003.2	5.0	no	12.5 x 90	10 x 100	4.60	0.024

\* Capped.

## 0.2 ml Real Time PCR tubes

Tubes made of polypropylene, featuring attached hinged caps.  
Flat caps are easily pierceable and offer optical quality, thus allowing their application in **Real Time PCR**.  
Available in strips of 8 tubes (see code **4095.1NP** in the following page).  
Certified **RNAse, DNase and PCR inhibitors free**.



code	description	case quantity	case weight	case volume
4094.5N	PCR 0.2 ml QPCR tube	1,000	0.25	0.003

## 0.2 ml PCR tubes

Tubes made of polypropylene, featuring attached hinged caps.  
**Caps are flat and easily pierceable.**  
See strips of these tubes on the following page (codes **4094.3N** and **4094.4N**).  
Certified **RNAse, DNase and PCR inhibitors free**.



code	colour	case quantity	case weight	case volume
4094.1N	natural	1,000	0.24	0.003
4094.1A	blue	1,000	0.24	0.003
4094.1R	red	1,000	0.24	0.003
4094.1AM	yellow	1,000	0.24	0.003

Ask for minimum quantity and delivery time for other colours.

## 0.2 ml PCR tubes

Made of polypropylene.  
Tubes with attached domed cap.  
Certified **RNAse, DNase and PCR inhibitors free**.



code	description	colour	case quantity	case weight	case volume
4095.9N	individual tube with cap	natural	1,000	0.25	0.003



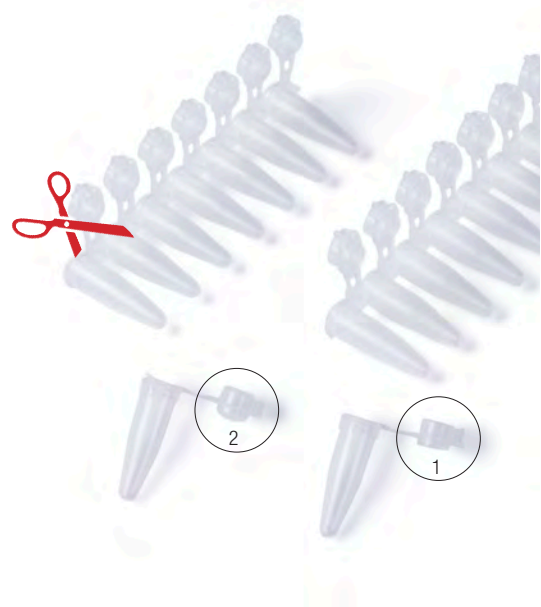
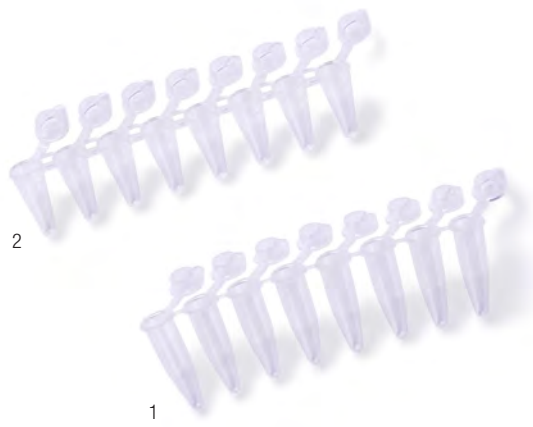
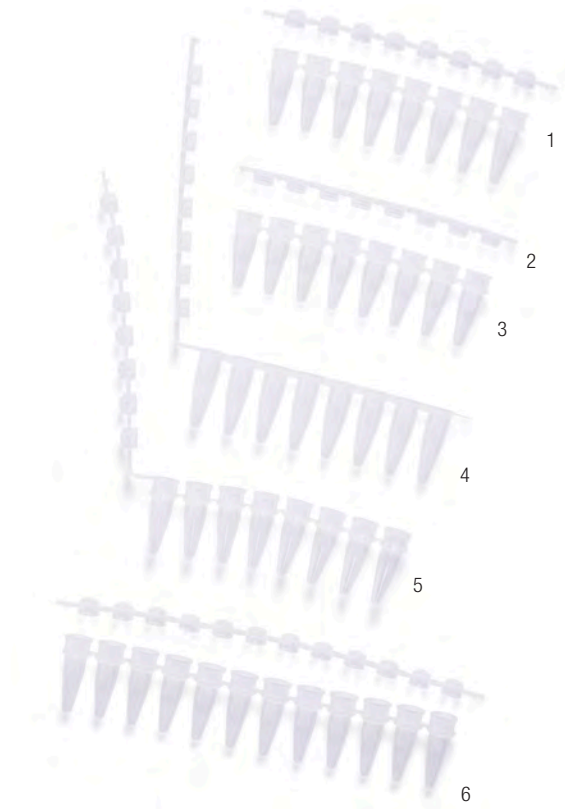

### 0.2 ml PCR tubes in strips

Made of natural colour polypropylene. Different models available:

- Strip of 8 or 12 tubes with its corresponding strip of 8 or 12 domed caps.
- Strip of 8 tubes with its attached hinged strip of domed caps.
- Strip of 8 tubes with its attached hinged strip of flat caps, suitable for **Real Time PCR**.
- Strip of 8 flat caps, suitable for **Real Time PCR**.

Cap and tube strips allow easy handling and inventory of tubes and caps. Cap strips prevent cross-contamination from tube to tube.

Code **4095.7N** is also suitable for plates. **Certified RNase, DNase, pyrogen and PCR inhibitors free.**



	code	description	case quantity	case weight	case volume
1	<b>4095.2N</b>	8 tube strip + 8 domed cap strip	125 strips	0.30	0.0036
2	<b>4095.7N</b>	strip of 8 flat caps	125 strips	0.07	0.0008
3	<b>4095.6N</b>	8 tube strip	125 strips	0.22	0.0028
4	<b>4095.1NP</b>	8 tube strip attached to 8 flat cap strips	125 strips	0.23	0.0036
5	<b>4095.1N</b>	8 tube strip attached to 8 domed cap strips	125 strips	0.23	0.0036
6	<b>4095.4N</b>	12 tube strip attached to 12 domed cap strips	80 strips	0.20	0.0028

Ask for another colours.

### 0.2 ml PCR tubes in strips

Tubes made of polypropylene, featuring attached hinged caps.

Suitable for **Real Time PCR**.

See individual tubes on page 67 (**4094.1N**). Caps are flat and easily pierceable. In bags of 10 strips.

Available in standard height (code **4094.3N**) and low profile (code **4094.4N**) that minimizes the effects of condensation and it allows working with small samples even less than 20 µl. **Certified RNase, DNase, pyrogen and PCR inhibitors free.**



	code	description	case quantity	case weight	case volume
1	<b>4094.3N</b>	strip of 8 tubes and 8 attached caps	120 strips	0.27	0.0036
2	<b>4094.4N</b>	strip of 8 tubes and 8 attached caps <b>low profile</b>	120 strips	0.22	0.0028

### 0.2 ml PCR tubes in strips

Made of polypropylene.

The strip includes 8 integral 0.2 ml tubes with ultra thin sidewalls and bottoms with individually attached caps. Available with either **flat (needle pierceable)** or **dome-topped individually** attached hinged caps.

Every cap embodies a shield in order to prevent contamination when being opened.

While easily opened and closed with one hand, their positive sealing will fully protect the contents from evaporation during the whole thermal cycle. These strips can be cut to any length while each tube has its own attached cap.

**Certified RNase, DNase and pyrogen free.**



	code	cap	case quantity	case weight	case volume
1	<b>4096.2N</b>	flat	125 strips	0.40	0.055
2	<b>4096.3N</b>	domed	125 strips	0.43	0.003



## Real Time PCR

**Polimerase Chain Reaction is one of the most common techniques in every lab where Molecular Biology is being used.** Its applications comprise **Diagnostics, Genetic and Prenatal testing, Tissue Typing, Forensics, Pharmacological evaluation**, among others.

One of the **most useful PCR techniques** is the **Real Time PCR**, also known as **Quantitative PCR (QPCR)**. Its main advantage in front of standard PCR is that it saves time as the quantification is being held during DNA amplification. While standard PCR needs a quantifying process after DNA amplification, **QPCR gives results in real time**.

PCR standard consumables are mainly made of transparent polypropylene. After some years of experience, laboratory technicians have found that **crosstalking among transparent wells may affect the real time quantification**. **Opaque white wells and tubes** have proved to avoid this well-to-well crosstalking, thus **ensuring an exact and reliable quantification**.

Opac wells also allows luminosity absorption.

The following pages include the newest innovations in this brand new area; like **bi-mould technologies**, which allow the manufacture of an opaque tube attached to an optically clear cap.

White well technology is available in both strips of tubes or also 96 well plates.

CELL CULTURE. MOLECULAR BIOLOGY

### 0.2 ml, Real Time PCR tubes in strips

Tubes made of polypropylene.

Strip of 8 tubes, each one featuring an attached flat cap.

Strips are manufactured by biomaterial molding, so the tubes are made of opaque white PP, while caps are compounded of transparent, optically clear PP. Opaque white tubes perform the highest performance in **Real Time PCR**, as they avoid crosstalking between wells.

Specially conceived for **Real Time PCR**.

Caps are easily pierceable.

In bags of 10 strips.

**Certified RNase, DNase and PCR inhibitors free.**

**Autoclavable at 121°C.**



code	description	case quantity	case weight	case volume
4094.5BP	strip of 8 white 0.2 ml QPCR tubes and 8 attached caps	120	0.27	0.004

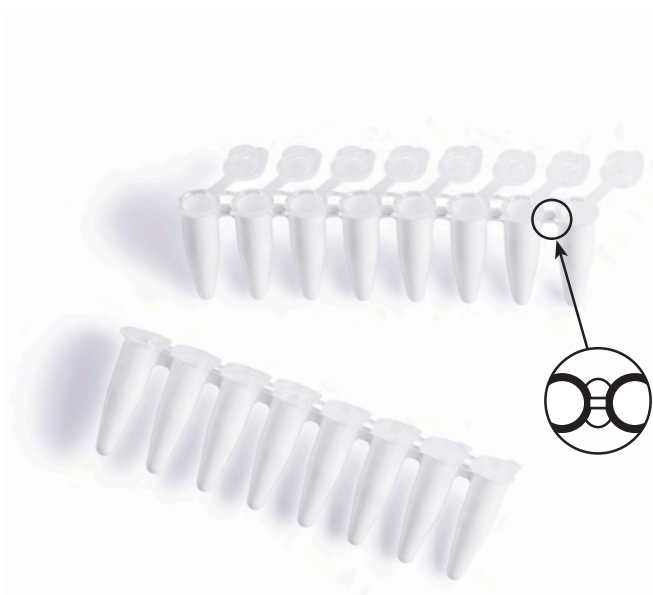

### 0.2 ml, Real Time PCR tubes in strips

Tubes made of polypropylene.

Strip of 8 tubes, featuring an attached strip of 8 flat caps. Strips are manufactured by biomaterial molding, so the tubes are made of opaque white PP, while caps are compounded of transparent, optically clear PP. Opaque white tubes perform the highest performance in **Real Time PCR**, as they avoid crosstalking between wells. Specially conceived for **Real Time PCR**.

Caps are easily pierceable.

**Certified RNase, DNase, pyrogen and PCR inhibitors free.**

**Autoclavable at 121°C.**



code	description	case quantity	case weight	case volume
4095.1BP	strip of 8 white 0.2 ml QPCR tubes and 8 caps	125	0.23	0.004







### Graduated 0.5 ml PCR tubes

Made of **autoclavable** polypropylene.  
Attached hinged caps are flat and easily pierceable.  
Tubes are easily opened and closed with one hand.  
Tubes have moulded-in graduations in 0.1 ml increments from 0.1 up to 0.6 ml, and a frosted panel on their side for writing or labelling.  
**Certified RNase, DNase and pyrogen free.**



code	colour	case quantity	case weight	case volume
4094.2N	natural	1,000	0.38	0.005
4094.2AM	yellow	1,000	0.38	0.005
4094.2A	blue	1,000	0.38	0.005
4094.2R	red	1,000	0.38	0.005

### Graduated 0.5 ml PCR tubes

Same features as the above tubes, but with a domed cap.



code	colour	case quantity	case weight	case volume
4095.5N	natural	1,000	0.46	0.005

### 384 wells plate skirted

Made of transparent polypropylene. 384 wells plate.  
Each well has a capacity of 50 µl.  
A low rim around the top of each well helps to prevent accidental cross-contamination  
All wells are thin walled for an excellent thermal transfer.  
Orientation cut is at position A 24 (upper right).  
A black printed alphanumeric grid helps sample identification.  
Suitable for **PCR** and **real time PCR (QPCR)**.  
Dimensions according to the **SBS** standard.  
**RNase, DNase, DNA and PCR inhibitors free.**



code	description	case quantity	case weight	case volume
900384	PCR 384 PLATE	10 x 10	3.20	0.026

Minimum order quantity: 10



PCR Plates – COMPATIBILITY CHART			900111	900110 unskirted	900122 semi skirt	900112 semi-skirt	900138 semi skirt	900123 skirted	900384 skirted	9000098 unskirted	9000095 white, skirted	9000093 black, skirted	
Well Shape													
Standard well. (Overall height approx. 21 mm, max. capacity approx. 350 µl)			●		●					●			
Low profile well. (Overall height approx. 16 mm, max. capacity approx. 200 µl)				●		●	●	●	50 µl			●	
AMERSHAM	Thermal Cyclers	MegaBace 500						●			●		
		MegaBace 1000						●			●		
		MegaBace 4000							●				
APOLLO BRAND	Thermal Cyclers	ATC401	●							●	●		
APPLIED BIOSYSTEMS	Thermal Cyclers	GeneAmp® 2700	●		●				●		●		
		GeneAmp® 2720									●		
		GeneAmp® 9600	●		●							●	
		GeneAmp® 9700	●		●							●	●
		GeneAmp® 9800 FAST BLOCK				●							
		Veriti 0,1 ml				●							
		Veriti 0,2 ml			●								
		Veriti 384								●			
	"Real Time" Cyclers	5700	●		●							●	
		PRISM 7000	●		●							●	
		7300	●		●							●	
		7500	●		●							●	
		7500 "Fast"				●							
		7700	●		●							●	
		7900								●		●	
		7900HT Fast	●			●							
		7900HT Standard 96											
		7900HT, 384								●			
		Step one / Step One Plus		●		●							
		ViiA7™					●			●		●	
		Sequencers	PRISM 310				●						●
	PRISM 3100				●							●	
	3130 (XL)				●							●	
	3700 DNA				●					●		●	
	PRISM 3730 (XL)				●							●	
	BECKMAN	Sequencers	CEQ	●								●	
	BIOMETRA	Thermal Cyclers	Uno	●	●	●			●			●	●
Uno II			●	●	●				●		●	●	
T1 Thermal Cycler			●	●	●			●	●		●	●	
Tgradient			●	●	●							●	●
Trobot			●	●	●				●	●		●	●
TProfessional			●	●					●	●		●	●
BIO-RAD/MJ RESEARCH	Thermal Cyclers	C1000/S1000	●	●	●			●	●		●	●	
		DNA Engine family	●	●	●			●	●				
		Dyad/Dyad Disciple	●	●	●				●	●			
		Gene cycler	●										
		iCycler	●		●			●			●		
		Mini Gradient	●	●								●	
		MyCycler	●									●	
		Personal	●		●								
		PTC-100	●	●	●				●	●		●	●
		PTC-200	●	●	●				●	●		●	●
	"Real Time" Cyclers	PTC-221										●	●
		PTC-225 Tetrad	●	●	●				●	●		●	●
		CFX384™								●			●
		CFX96™							●				●
		Chromo4™		●					●				●
		iCycler™	●		●					●		●	
		iq™4 / iq™5	●		●					●		●	
		MiniOpticon™										●	
		MyiQ	●		●				●			●	
		MyiQ2	●		●				●			●	
Sequencers	Opticon™, Opticon 2™		●					●				●	
	BaseStation							●					



PCR Plates – COMPATIBILITY CHART			900111	900110 unskirted	900122 semi skirt	900112 semi-skirt	900113B semi skirt	900123 skirted	900384 skirted	900098 unskirted	900095 white, skirted 900093 black, skirted	
Well Shape												
Standard well. (Overall height approx. 21 mm, max. capacity approx. 350 µl)			●		●					●		
Low profile well. (Overall height approx. 16 mm, max. capacity approx. 200 µl)				●		●	●	●	50 µl		●	
CORBETT RESEARCH	Thermal Cyclers	PalmCycler 96		●	●			●				
		PalmCycler 384							●			
EPPENDORF	Thermal Cyclers	Mastercycler	●	●	●			●				
		Mastercycler Gradient								●	●	
		Mastercycler ep Gradient	●		●			●			●	
		Mastercycler M384								●		
		Mastercycler Nexus	●	●	●			●				
		Mastercycler Nexus Eco	●	●	●			●				
		Mastercycler Pro	●	●	●			●			●	
		<i>“Real Time” Cyclers</i>	Mastercycler ep Realplex	●		●			●		●	
ERICOM	Thermal Cyclers	Power Block I	●	●								
		Deltacycler I	●	●	●						●	
		Deltacycler II	●	●							●	
		Single Block	●	●	●						●	
ESCO	Thermal Cyclers	Swift	●		●							
		Gene	●		●			●	●			
G-STORM	Thermal Cyclers	GS1	●	●	●							
		GS2	●	●	●							
		GS4	●	●	●							
		GS5X	●	●	●							
		GSxs	●	●	●							
MWG	Thermal Cyclers	Primus 96	●	●	●			●		●	●	
		Primus 384							●			
	<i>“Real Time” Cyclers</i>	TheQ Lifecycler	●	●			●			●	●	
PEQLAB	Thermal Cyclers	peqSTAR 96								●		
ROCHE	Thermal Cyclers	LightCycler 96					●					
		<i>“Real Time” Cyclers</i>	LightCycler 480				●					
SENSOQUEST	Thermal Cyclers	LabCycler Basic 96								●	●	
		LabCycler Gradient 96								●	●	
STRATAGENE	Thermal Cyclers	Robocycler 96	●		●					●		
		RoboCycler® Gradient	●		●			●				
		Gradient Cycler									●	●
		Mastercycler® Gradient									●	●
		MasterCycler®EP Gradient/Pro									●	●
		M384										
	Surecycler 8808			●					●			
	<i>“Real Time” Cyclers</i>	Mx4000®	●							●		
	Mx3000P®, Mx3005P™	●							●			
	Mastercycler® ep realplex								●	●		
TAKARA	Thermal Cyclers	TP240						●				
		TP3000	●	●	●			●		●	●	
TECHNE	Thermal Cyclers	Genius	●	●	●					●	●	
		Genius Quad	●	●	●					●	●	
		Genius TC-412	●	●	●			●		●	●	
		Genius, Touchgene, TC-512, TC-5000								●	●	
		Prime / Prime G Full Size	●		●			●	●			
		TC Plus								●	●	
		Touchgene	●	●	●							
		Touchgene Gradient (TC512)	●	●	●			●	●	●	●	
<i>“Real Time” Cyclers</i>	Touchgene X	●	●				●	●				
THERMO HYBAID	Thermal Cyclers	Quantica			●			●				
		MBS Satellite system	●	●	●			●	●	●	●	
		MultiBlock System								●	●	
		Omn-E								●	●	
		Omnigene	●	●	●			●	●	●	●	
		PCR Express and Omni-E	●	●	●			●	●	●	●	
		PCR Sprint	●	●	●			●			●	
		Px2 and PxE	●	●	●			●	●	●	●	
TRANSGENOMIC	Sequencers	Proflex	●		●				●			
		Touchdown	●	●	●			●	●	●	●	
		Wave						●		●		

## 96-well flexible PCR plate

Made of polypropylene.

It is suitable for both real time and standard PCR thermocyclers.

This 96-well PCR plate is thin-walled for rapid thermal transfer. Flexible, the plate could be easily cut into sections of 24, 32 or 48 tubes.

An alphanumeric grid helps sample identification, and to facilitate orientation, the bottom right corner of the plate is cut away.

**Certified RNase and DNase free.**

**Dimensions:** 120 x 73 x 20 mm.

Dimensions according to the **SBS** standard.



code	colour	case quantity	case weight	case volume
900098	natural	10	0.22	0.0024

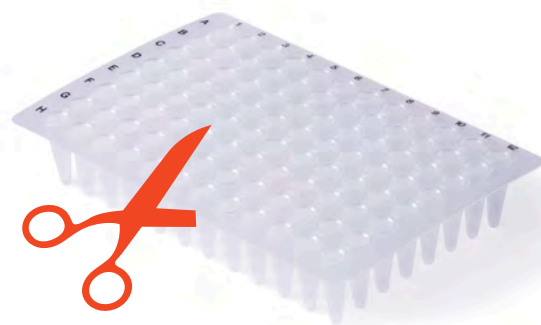

## 96-well low profile skirted PCR plate

Made of polypropylene. Each "low profile" well has a capacity of 200 µl. A low rim around the top of each well helps to prevent accidental cross-contamination and makes easy the sealing with film.

All wells are thin walled for an excellent thermal transfer.

This plate has a skirt approximately 15 mm high that can be filled using automatic fluid handling systems or standard multichannel pipettors.

A black printed alphanumeric grid helps sample identification.

Orientation cut is at position A 12 (upper right).

**RNase, DNase, DNA and PCR inhibitors free.**

Suitable for PCR and real time **PCR (QPCR)**.

Dimensions according to the **SBS** standard.



code	colour	case quantity	case weight	case volume
900123	natural	10	0.30	0.003



## Opaque skirted 96 well PCR plate

Made of polypropylene.

Alphanumeric identification.

The skirt around the plate provides a labelling area. Conical-bottomed wells.

The plate can be handled by robotic equipment and is ideal with automated pipetting systems. To facilitate orientation, the bottom right corner of the plate is cut away.

Well dimensions: 5.5 mm. Well depth: 14 mm.

Code **900093**: Black plate for fluorescent PCR.

Code **900095**: White plate for luminescence (optical absorption) PCR.

**Certified RNase and DNase free.**

**Dimensions:** 126 x 84 x 15 mm.

**Well plate volume:** 100 µl.



code	description	case quantity	case weight	case volume
900093	96 well black plate	5 x 10	1.35	0.010
900095	96 well white plate	5 x 10	1.35	0.010



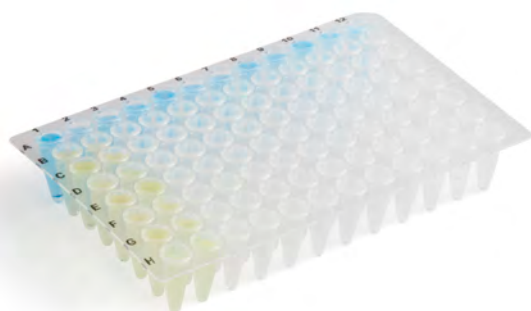

## 96 well standard plate

Made of transparent polypropylene.

96 wells standard plate with a capacity of 350 µl each well.

A low rim around the top of each well helps to prevent accidental cross-contamination and makes easy the sealing with film.

All wells are thin walled for an excellent thermal transfer.

A black printed alphanumeric grid helps sample identification.

Orientation cut is at position A 12 (upper right).

**RNase, DNase, DNA and PCR inhibitors free.**

Suitable for PCR and real time PCR (QPCR).

Dimensions according to the SBS standard.



code	colour	case quantity	case weight	case volume
900111	natural	10 x 10	2.72	0.027

## 96-well low profile PCR plate

Made of transparent polypropylene.

Low profile well (15 mm high).

Perfect to work with samples of 100 µl or even less.

A low rim around the top of each well helps to prevent accidental cross-contamination.

The orientation cut is at position H 12 (lower right).

A printed alphanumeric grid helps sample identification.

**DNase, RNase, DNA and PCR inhibitors free.**

It is suitable for both standard or Real Time PCR.

Dimensions according to the SBS standard.



code	description	case quantity	case weight	case volume
900110	low profile PCR plate	5 x 20	1.9	0.018



## 96 well semi-skirt plate

Made of transparent polypropylene.

This plate has a semi skirt ±7.5 mm high.

Each well has a capacity of 200 µl and embodies a low rim around its top which prevents accidental cross-contamination and it makes easy the sealing with foils.

Orientation cut is at position A 12 (upper right).

Alphanumeric identification printed in black.

**DNase, RNase, DNA and PCR inhibitors free.**

Dimensions according to the SBS standard.



code	description	case quantity	case weight	case volume
900122	semi-skirt PCR plate	10	0.32	0.003



## 96 wells low profile, semi-skirted white plate

### Specially designed for Roche thermocycler.

Made of white polypropylene. Semi-skirt "low profile" 96 well. Each well has a capacity of 200 µl.

A low rim around the top of each well helps to prevent accidental cross-contamination and makes easy the sealing with film.

Orientation cut is at position H 12 (bottom right).

A black printed alphanumeric grid helps sample identification.

### RNase, DNase, DNA and PCR inhibitors free.

Suitable for PCR and real time PCR.

Dimensions according to the SBS standard.



code	description	case quantity	case weight	case volume
900113B	semi-skirt PCR plate	10 x 10	2.96	0.027

## 96 well, low profile, semi-skirted plate

### Specially designed for ABI "Fast" thermocycler.

Made of transparent polypropylene with frosted appearance.

Semi-skirt "low profile" 96 well.

Each well has a capacity of 200 µl.

A low rim around the top of each well helps to prevent accidental cross-contamination.

Orientation cut is at position A 1 (upper left).

A black printed alphanumeric grid helps sample identification.

### RNase, DNase, DNA and PCR inhibitors free.

Suitable for PCR and real time PCR (QPCR).

Dimensions according to the SBS standard.



code	description	case quantity	case weight	case volume
900112	semi-skirt PCR plate	10 x 10	2.96	0.027





### PCR sealing mat

Manufactured from a non reactive rubber, this PCR sealing mat ensures a secure, leak free seal during the PCR cycling process.

It is designed to seal **96 well PCR plates**, but may also be cut to fit 24/32/48 well plates.

The mat is marked "*this side up*" for a proper positioning into the plate (sharp cone side up). This sealing mat may be sterilized in an **autoclave** or cleaned by immersion in a bleach solution.

**DNase, RNase, DNA and PCR inhibitors free.**



code	description	case quantity	case weight	case volume
900305	PCR sealing mat	10 x 5	1.20	0.012

### Adhesive sealing film

Sealing film for use with microplates, multiwell plates and microtiter plates.

Advantages:

1. Minimises the risk of contamination or reagent spillage during ELISA or PCR processes.
2. Minimises the risk of contamination from tube to tube and from plate to plate.
3. Prevents sample evaporation.

A 5 mm wide strip (opaque white) at the lateral edges of the film helps pull the film from its protective paper and prevents it sticking onto fingers. The film is thermostable and functional from **-70 °C to 95 °C** at 75% humidity.

**RNase and DNase free.** DMSO resistant.

We recommend to use the "roller" **900330** to ensure a perfect seal.



code	description	case quantity	case weight	case volume
900300	adhesive film	1 x 100	0.23	0.0005
900301	adhesive film suitable for QPCR	1 x 100	0.06	0.0004
900330*	sealing roller	1	0.01	0.0001

### Aluminum sealing foil

This type of material is ideal for manual sealing during PCR work, microtiter plates or manipulation and archive.

For high throughput applications from **-80 °C to 120 °C**.

Adhesive backing.

Pierceable with a pipette tip for easy access to sample.

DMSO resistant.

It is recommended to use the "roller" code **900330** for ensuring a perfect sealing, eliminating the danger of evaporation.

**Dimensions:** 14x8 mm

**RNase, DNase and DNA free.**



code	description	case quantity	case weight	case volume
900320	aluminum foil	1 x 100	0.28	0.0003
900330*	sealing roller	1	0.01	0.0001



## Deep well plate (96 wells or 12 rectangular channels)

Made of medical grade polypropylene, composed of 96 square wells. V-shaped bottom squares, each with 2 ml capacity. Numeration. Alphanumeric mold that facilitates the identification of samples. Widely used for dispensing and storage of liquids, since either by manual or automatic pipetting (robotic).

Resists temperatures from **-80 °C to 121 °C (autoclave)**.

**Certified as free of RNase, DNase, DNA and PCR inhibitors free.**

Manufactured according to SBS standards. Stackable.

### Sealing mat.

Made of **autoclavable** silicone, exclusive for square well plates.

Alphanumeric marking in black for easy identification of wells.

It is pierceable, so it should not be removed to aspirate the sample.

It has 2 tabs on the right side for easy positioning.



mod.	code	description	case quantity	case weight	case volume
1	900198	96 well plate 2.0 ml	5	0.58	0.0032
2	900310	PCR sealing mat	10	0.14	0.0008



## 96 deep well plate (96 round wells)

Made of medical grade polypropylene, it is made of 96 round bottom wells, each one of 1.2 ml capacity. Printed alphanumeric grid helps sample identification, and to facilitate orientation the bottom right corner of the plate is cut away.

Widely used for liquid handling and storage, with manual pipetting or robotic handling.

It withstands temperatures from **-90 °C to 121 °C (autoclave)**.

**Dimensions according to SBS.**

**Certified free from detectable RNase, DNase, DNA and PCR inhibitors free.**



code	description	case quantity	case weight	case volume
900156	96 well plate 2.0 ml	5	0.51	0.003



## 96 deep well plate (square well, round bottom)

Made of polypropylene. The 2.1 ml well capacity (2.0 when capped) plate is used mainly for compound storage and enzyme assays. An alphanumeric grid helps sample identification, and to facilitate orientation the bottom right corner of the plate is cut away. DMSO resistant. Can be centrifuged up to **6000 xg**.

It withstands temperatures up to **-150 °C. Autoclavable**.

Each well measures 8.3 x 8.3 mm.

Plate dimensions: 41.6 mm high x 127.8 mm long x 85.5 mm wide.

We recommend to protect the samples with the sealing mat code **900306** (DMSO resistant).

**RNase, DNase, DNA and PCR inhibitors free.**



code	description	case quantity	case weight	case volume
900170	96 deep well plate, natural colour	4	0.47	0.002
900306	sealing mat	24	3.60	0.002





## Sample storage system

96 round bottom tubes, supplied in twelve strips of eight tubes each, held in a rack with lid. Rack, lid, tubes and caps are made of **autoclavable** polypropylene, manufactured with the **SBS** standard footprint.

Compatible with all robotic applications and multichannel pipetting systems.

Alphanumeric numbered wells, indelibly printed in black, allowing identification in short light conditions. **DNase, RNase, DNA and PCR inhibitors free.**

Used for serial dilutions, mixing, storage and harvesting of cells, cell growth for cell culture assays and DNA screening, and as an ideal long-term storage system. Caps are sold separately in strips of eight or twelve units, depends on the model; every cap has a tag to make an easy opening and closing.

Tube dimensions (height): 8 x 44 mm

Rack dimensions (with lid): 128 x 86 x 48 mm



code	description	case quantity	case weight	case volume
409009	rack with 96 tubes (8 x 12)	10	1.63	0.010
409010	strips of 8 tubes each	125 strips	0.27	0.007
409011	strips of 8 caps each	125 strips	0.11	0.012
409012	loose tubes	1,000	0.63	0.005



## Sample storage system

Compact sample storing system. It consists on a blue rack with a translucent lid, holding 96 loose round bottom tubes (1,2 ml) arranged in 8 x 12. Robotics suitable version (**RC845TP**). **Autoclavable** and stackable, it resists up to **-100 °C**, and embodies a moulded alphanumeric identification.

Rack, lid and tubes made of polypropylene. Caps made of low density polyethylene.

Caps are sold apart in strips of eight units; every cap has a tag to make an easy opening and closing.

Tube dimensions (height, closed): 8,8 x 45 mm.

Rack dimensions (with lid): 118 x 82 x 50 mm.

**DNase, RNase free.**

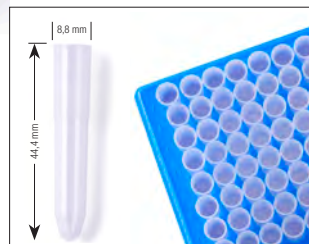

code	description	case quantity	case weight	case volume
RC845TP*	rack with 96 tubes for robotics	10	1.14	0.010
409005	strips of 8 caps each	120 strips	0.16	0.002
845	tubes in bulk	1,000	0.60	0.004

\* pyrogen free

## Sample storage system

Made of a white rack and a transparent lid, with 96 tubes (12 x 8) 1.2 ml (capped, 1.1 ml).

Tubes and rack are manufactured in polypropylene, being autoclavable.

Caps in non **autoclavable** polyethylene.

Caps are acquired apart, in strips on eight units.

It is ideal to work with robots and multichannel pipetting systems, as well as for sample transport, storage, or freezing (it can withstand up to **-80 °C**).

It stands up the majority of chemical agents.

Both lid and rack embody an alphanumeric identification.

The top left edge of the lid is cut for an exact orientation.

**Tube dimensions** (capped): 9 x 48 mm.

**Rack dimensions** (with lid): 126 x 81 x 53 mm.

According to **SBS** standard.

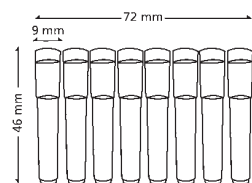

code	description	case quantity	case weight	case volume
409004	rack with 96 tubes (8 x 12)	10	1.80	0.009
408002	tubes of 8 caps each	120 strips	0.73	0.005
408005	strips of 8 caps each	120 strips	0.09	0.001
408003	loose tubes	5 x 960	3.88	0.028



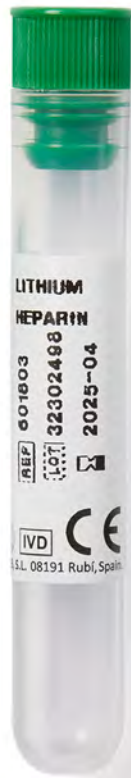

# 03. HEMATOLOGY & BIOCHEMISTRY



## Procedures and controls

During the manufacturing process of the tubes for extraction, periodic checks are carried out, among which are:

- Reproducibility dosing control
- Quantity and quality dosing control
- Watertightness control
- Centrifugal Resistance Control

Each case includes a brochure with recommendations of use.

## Expiry date on our tubes, anticoagulants and other

- Serum tubes (granules and gel) ..... 24 months
- Serotub Glucose ..... 12 months
- Lithium heparin ..... 24 months
- Iodoacetate heparin ..... 13 months
- Edta ..... 24 months
- Citrate for coagulation ..... 15 months
- Anticoagulants in containers ..... 24 months
- Thrombocyte count and osmotic brittleness ..... 24 months
- Reticulocyte vital staining ..... 24 months



## 100% Traceability

Our blood collection tubes are individually identified with its code, LOT number and expiry date, so the traceability from its manufacture to the final consumer is guaranteed. **Raw materials traceability. Process traceability. Final product traceability.**

We manufacture our blood collection tubes according to the following:

- **EU Regulation No. 2017/746** on *in vitro* diagnostic medical devices.
- **EN ISO 14971** - Application of risk management to medical devices
- **EN ISO 6710** - Single-use containers for venous blood collection
- **ISO 15223-1** - Medical devices - Symbols to be used on labels, labelling and information to be supplied - Part 1: General requirements
- **EN ISO 13485** - Medical devices - Quality management systems - Requirements for regulatory purposes



## Serum glucose serotub

Transparent polypropylene tubes, covered and labelled with detail of lot number, expiration and volume.

With ergonomic cap in inert polyethylene.

Tubes treated with inert additive for rapid clot retraction and serum separation.

As well as inert granules, rounded to avoid possible lesions in erythrocytes at the time of centrifugation and its consequent risk of haemolysis.

These granules act as a barrier that, without being airtight (as in the case of the gel), ensures comfortable pipetting or decanting of serum.

They allow most biochemical, glucose and creatinine measurements to be performed in a single tube, except for CPK and lithium, thus saving the use of two tubes, one for routine tests and the other for glucose.

Presentation: in black bags due to the photosensitivity of the product

**Store at room temperature.**

It is supplied in plastic racks.

**Expiration:** 12 months.



code	description	case quantity	case weight	case volume	pallet quantity
600602	13 x 75 for 4 ml blood	12 x 100	4.92	0.033	42

Ask for minimum quantity and delivery time for tube 16 x 100. 10 ml blood.



## Silicone and TPE tourniquet

Product intended for the retention of the blood flow by oppression of a corporal limb for extracting blood samples, differentiate a vein, ...etc.

### Silicone tourniquet

**Dimensions:** 18 mm wide, 0.8 mm thickness.  
Non toxic, USP, Class VI, silicone. **Autoclavable.**  
Material of high transparency and non smelly.

### TPE tourniquet

**Dimensions:** 25 mm wide, 0.6 mm thickness and 450 mm length.  
Manufactured with TPE, thermoplastic elastomer. Latex-free product, non cytotoxic and non-irritant.



mod.	code	description	dimensions	quantity	weight	volume
1	GS-02	silicone	box with 10 bands 0.5 m long each	1	0.11	0.001
2	TQ	TPE	450 mm	1,000	7.00	0.019



## Serum tubes with clot accelerator and gel serum separator

Made of a clear polypropylene, supplied capped and labelled with an inert polyethylene cap.

The tubes are designed and processed to permit a fast serum and blood clot separation.

Each tube contains a special inert additive which accelerates the coagulation, and the result is a **fast clot retraction**.

The coagulation speed is, doubtlessly, much higher than the obtained with the glass tubes or the other existing tubes on the market.

The inert gel is located, after centrifugation, between the clot and the obtained serum and it works as a totally watertight barrier.

The ergonomic features of the cap design results in a very reliable and easy-to-use cap.

The lot number, expiry date and volume are printed on the label of each tube.

Supplied in plastic racks.

We strongly recommend its usage for biochemistry, routine tests, special biochemistry, markers, hormones, immunology (tube without anticoagulants).

Expiry time in 24 months.



code	description	case quantity	case weight	case volume	pallet quantity
600801	13 x 75 round for 4 ml	12 x 100	5.40	0.030	48
600800	16 x 100 round for 9 ml	6 x 120	6.00	0.040	36

## Serum tubes with clot accelerator and gel serum separation

**Clotting speed increased:** with our tubes processed with gel serum separator and accelerator we improve the clotting speed achieving a 20-25% advantage over glass tubes. The serum is obtained after 15 minutes, depending on the particular working conditions.

**Serum volume increased:** The volume obtained is higher than the obtained with granules tubes or glass tubes, achieving an advantage around 20%. The gel serum separator tube is the preferred option when analysis requires maximum serum yield from the blood sample.

Recommended in case the objective is to obtain larger serum volume.

**Note:** Before using, the gel serum separator remains at the bottom, even when the tube is bent.

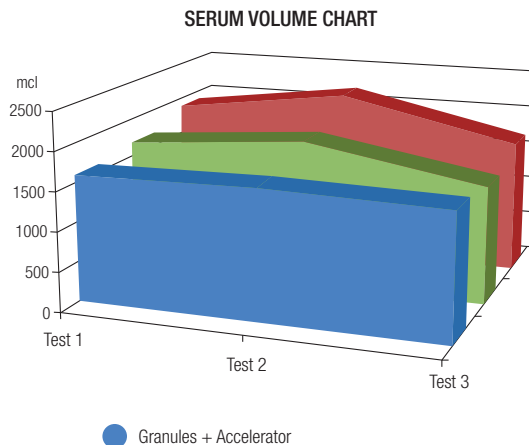
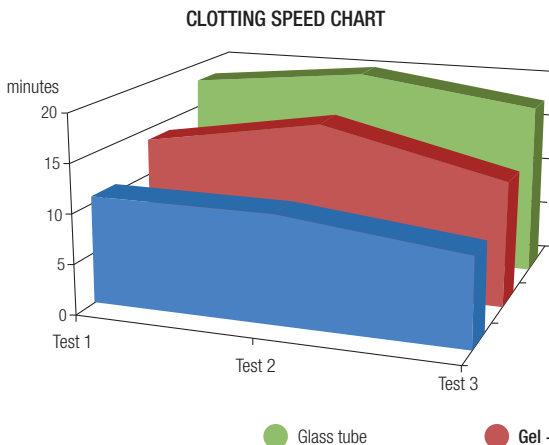

● Glass tube

● Gel + accelerator

● Granules + Accelerator



## Serum tubes with clot accelerator and granule serum separator

Made of a clear polypropylene, supplied capped and labeled with an inert polyethylene cap.

The tubes are designed and processed to permit a **fast serum and blood clot separation**.

Each tube contains a special inert additive which accelerates the coagulation, and the result is a fast clot retraction. The coagulation speed is much higher than the obtained with the glass tubes or the other existing tubes on the market. Allows the obtention of serum in 12 min.

The inert **granules are rounded** to avoid cellular lysis during centrifugation and minimize the risk of haemolysis. These granules are located between the clot and the separated serum working as a retaining wall. It assures a comfortable pipette action or serum decanting. (It isn't a watertight barrier).

The ergonomic features of the cap design results in a very reliable and easy-to-use cap.

The lot number, expiry date and volume are printed on the label of each tube.

Expiry time in 24 months.



code	description	case quantity	case weight	case volume	pallet quantity
600400	13 x 75 round for 4 ml	2 x 1.000	7.90	0.045	32
600300	16 x 100 round for 9 ml	2 x 500	6.10	0.045	32
707094*	bottle of 750 g with separator granules	20	17.50	0.045	40

\* Product without CE mark



## Serum tubes with clot accelerator and granules

**Clotting speed increased:** with our tubes processed with granules and accelerator we achieve a clotting speed higher than the obtained not only with glass tubes but also with gel tubes. The advantage achieved is around 40-50% over glass tubes. Serum can be obtained starting from 12 minutes, depending on working conditions.

**Serum volume increased:** The volume obtained is a little higher than the obtained with glass tubes but fewer than the obtained with gel serum separator tubes.

Due to its effectiveness and low price this product is highly recommendable for all routine serum tests.

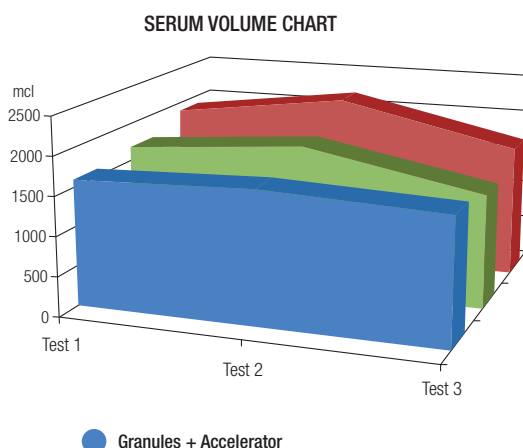
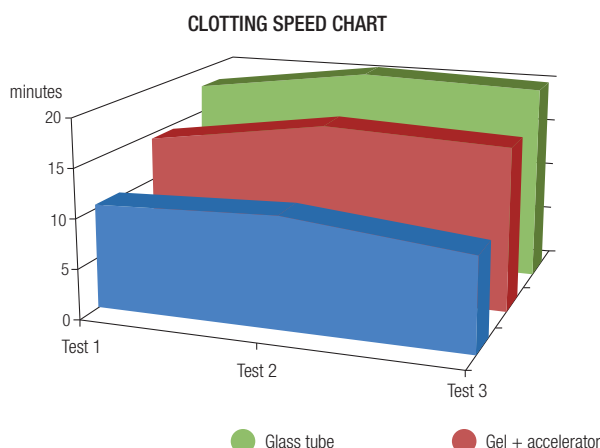





### Lithium heparin tubes

Made of clear polypropylene, supplied capped and labeled, indicating **filling line, lot number, and expiry date**.

The anticoagulant pulverization inside the tube optimizes the mixture and avoids the unnecessary blood dilution.

The anticoagulant mechanism is the inhibition of the thrombin action.

Supplied in plastic racks.  
Type of coagulant: **spray**.

**Expiry date:** 24 months.



code	description	case quantity	case weight	case volume	pallet quantity
601802	13 x 75 round for 4 ml blood	12 x 100	4.10	0.033	42
601803	13 x 75 round for 2.5 ml blood	12 x 100	4.10	0.033	42



### Iodoacetate lithium + heparin lithium tubes

Made of clear polypropylene, supplied capped and labeled. A fill line indicates the level of blood required on the label of each tube, as well as the **lot number and expiry date** which are printed on it.

The anticoagulant and preservative pulverization inside the tube optimizes the mixture and avoids the unnecessary blood dilution.

The blend anticoagulant-glucose preservative is ideal for biochemical tests, so it's possible to determine most of the biochemical parameters with only one tube and preserve the product stable for 4 days. It is recommended to maintain the tubes in a dark and cool place (at room temperature).

The tubes are packed in black bags in order to keep them out of the light because the iodum is photosensitive.

Supplied in plastic racks.

Type of coagulant: **liquid**.

**Expiry date:** 24 months.



code	description	case quantity	case weight	case volume	pallet quantity
602002	13 x 75 round for 4 ml blood	12 x 100	4.40	0.033	42
602003	13 x 75 round for 2.5 ml blood	12 x 100	4.30	0.033	42

## Edta: tripotassium

Made of clear polypropylene, supplied capped and labeled.  
Tetraceticetilendiamin acid, a tripotassium salt, works as an anticoagulant thanks to its capacity to fix the blood calcium. Because the anticoagulant is pulverized, it allows a mixture with the blood almost immediate.  
The quantity of additive is very small so there are no dilution mistakes (this may occur in the tubes with big additive liquid solution volumes). There is no risk of anticoagulant loss when uncapping because it is adhered to the tube walls.  
The cap shape, both internal and external design, assures a comfortable and reliable capping.

**A volume indication mark, lot number and expiry date on the label of each tube, allow to assure the traceability of the product.**

Supplied in plastic racks. Type of coagulant: **spray**.

**Expiry date:** 24 months.



code	description	case quantity	case weight	case volume	pallet quantity
601603	13 x 75 round for 2,5 ml blood	12 x 100	4.10	0.033	42
601702	13 x 75 round for 4 ml blood	12 x 100	4.14	0.033	42



## Edta: tripotassium. Rubber cap

Tubes made of clear polypropylene, supplied capped and labeled. Mauve, pierceable (but not pierced) and plugged cap made of thermoplastic rubber.  
Suitable for haematological automatic machines.

The label indicates **code, volume, lot number and expiry date**, assuring total traceability.

Tubes supplied in trays of 100 units.

Type of coagulant: **liquid**.

**Expiry date:** 24 months.



code	description	case quantity	case weight	case volume	pallet quantity
611604	13 x 80 for 3 ml blood	8 x 100	3.00	0.030	50
611603	13 x 75 for 3 ml blood	20 x 50	4.43	0.034	36



## Blood-plasma. Edta tubes: dipotassium

Made of clear polypropylene, supplied capped and labeled.  
Tetraaceticetilendiamin acid, a dipotassium salt, works as an anticoagulant thanks to its capacity to fix the blood calcium. Because the anticoagulant is pulverized, it allows a mixture with the blood almost immediate. The quantity of additive is very small so there are no dilution mistakes (this may occur in the tubes with big additive liquid solution volumes). There is no risk of anticoagulant loss when uncapping because it is adhered to the tube walls. The cap shape, both internal and external shape, assures a comfortable and reliable capping. **A volume indication mark, lot number and expiry date on the label of each tube, allows to assure the traceability of the product.**

Supplied in plastic racks. Type of coagulant: **spray**.

**Expiry time in 24 months.**



code	description	case quantity	case weight	case volume	pallet quantity
601402	13 x 75 round for 4 ml blood	12 x 100	4.10	0.033	42





### Speed sedimentation citrate for paediatrics

System for the determination of the erythrocyte sedimentation rate. Specially recommended for **Paediatrics**. The system consists of a tube and a pipette. The tube includes a pierceable and re-sealable stopper. Filled with 0.08 ml of trisodic citrate 0.106 M for 0.32 ml of blood according to standards of Westergren standard method. The pipette of pressure filling has an inner diameter of 1.25 mm and is graduated. Once blood and citrate are mixed together, introduce the pipette into the tube (without removing the stopper). The blood will automatically reach the 0 level. The results obtained are comparable to those obtained with the standard method (macro).

**Expiry date:** 12 months.



code	description	case quantity	case weight	case volume
27	set pipette + tube	400	3.28	0.029

### E.S.R. semi micro system TAKIVES with self-levelling system

Pipette graduated from 0 to 160 mm, with a total length of 200 mm and an inner diameter of 2.5 mm, according to the Westergren Method.

The **system accepts a total volume of 1 ml.**

The plunger must be drawn up manually up to a limit inside the pipette to ensure an adequate volume of blood-citrate blend.

Tube made of high transparency polypropylene.

**Expiry date:** 15 months.

Take a reading after 1 hour and the second after 2 hours



code	description	case quantity	case weight	case volume
1361*	rack for 5 mm tubes	5	3.20	0.020
1164	tube 12 x 55 with citrate pierceable cap	10 x 100	3.02	0.020

\* Product without CE mark

### E.S.R. with self-levelling system

**Code 29:** Consists of a polystyrene pipette with self-filling system using a plunger suitable for 12 mm or 13 mm diameter tubes. Graduated from 0 to 180 mm. 1.25 ml blood-citrate mixture is enough for determination.

**Expiry date:** 15 months.

**Code 132832:** Consists of a Soda glass pipette up to 180 ml, in white screen printed, with a piston in low density polyethylene incorporated.

**Measures:** 210 x 4.5 mm. **Expiry date:** 60 months.



code	description	case quantity	case weight	case volume
29	E.S.R. pipette. 230 mm long graduated up to 180 mm	3 x 200	2.60	0.027
132832	glass pipette SVG 180mm + plunger	4 x 500	3.15	0.0026
1361*	stand for 10 pipettes	5	3.20	0.020

\* Product without CE mark



## Mailing container

Mailing container with safety screw blue cap, both manufactured in polyethylene. Leak proof.

Ideal for 10 ml tubes.

The tube includes a piece of absorbent paper to prevent any leakage.

Container and cap are sold separately.

**Dimensions uncapped:** 117 x 30 mm.

**External mouth:** diametre 24,5 mm, internal: 21 mm.

code	description	case quantity	case weight	case volume
401301	mailing container	500	7.70	0.090
401302	screw cap	500	1.90	0.095



## Blood group test plate

Made of ultra clear polystyrene.

Features 10 numbered wells.

Stackable.

**Dimensions:** 160 x 40 x 6 mm.



code	description	case quantity	case weight	case volume
P010000	blood group plate	25 x 10	3.70	0.014



## Syringes

3-piece syringes formed by body, plunger and sealing gasket.

Transparent PP cylindrical body, with support fins and provided with a safety ring that prevents accidental exit of the piston.

With an indelible graduated scale according to the International System of Measurements.

In unitary container, sterilized by ethylene oxide.

Non-pyrogenic and latex free product, PVC and Phthalates free.

For version with needle, contact the sales department.



code	description	case quantity	case weight	case volume	volume du carton
JS1	1ml	3C centered luer	32 x 100	13	0.113
JS2	2ml	3C centered luer	30 x 100	13	0.113
JS3	5ml	3C centered luer	24 x 100	15	0.113
JS4	10ml	3C eccentric luer	16 x 100	15.5	0.113
JS5	20ml	3C eccentric luer	16 x 50	14	0.100
JS6	60ml	3C eccentric luer	16 x 25	16	0.120
JS8	60ml	3C catheter	16 x 25	17.00	0.120
JS9	100ml	3C catheter luer adapter	4 x 25	6.5	0.060



## Common problems in centrifugation

PROBLEM		POSSIBLE CAUSES	REASON FOR MISUSE	SOLUTION
The barrier is not clearly defined	Poor or incomplete serum separation. Barrier is intact and well defined	Incomplete or inhibited coagulation. Non-homogeneous blend of blood and coagulant  Early centrifugation, insufficient allowance coagulation time prior to centrifugation  Centrifugation xg-setting under appropriate value	The tube was not inverted for 5 times  The recommended 30 min. standing time for coagulation was not observed  The tube was not centrifuged at or above the minimum, appropriate xg-setting	After tube is filled with blood and capped, gently invert the tube for 5 times  Wait for 30 min before centrifugation  a) Set the centrifuge between 1,000-1,500 xg b) Confirm centrifuge is correctly calibrated
	Barrier is skewed and poorly formed, separation is incomplete	Less centrifugation time than recommended  Refrigerated centrifuge	The tube was not centrifuged for the required time  The temperature of the centrifuge was lower than the recommended	Centrifuge the tube at the appropriate xg-force for at least 10 min  a) Keep the centrifuge at a temperature between 24 °C and 26 °C (around 77 °F). b) Thermally insulate the tube and avoid contact with the centrifuge and centrifuge rotor
Blood tubes fracture during centrifugation		xg-force centrifugation exceeded the tube construction  Centrifuge not positioned level and/or foreign matter or debris inside the rotor of the centrifuge	The tube was subjected to xg-forces exceeding 1,500 xg  a) Shock absorbers or tube stand-off cushions absent. b) The inside of the rotor is not clean	Maintain centrifuge at or below 1,500 xg  Install shock absorbers or tube stand-off cushions as required. Remove any foreign agent or debris that may be inside the centrifuge
Cell clumps observed within the separation barrier		Incomplete or inhibited coagulation. Non-homogeneous blend of blood and coagulant  Insufficient time before centrifugation  Excessive xg-force centrifugation	The tube was not inverted for 5 times  The recommended 30 min standing time for coagulation was not observed  The tube was centrifuged at above 1,500 xg	Invert the tube for 5 times  Wait for 30 minutes before centrifugation  Set the centrifuge at a speed below 1,500 xg
Presence of fibrin in serum		Incomplete or inhibited coagulation. Non-homogeneous blend of blood and coagulant  Early centrifugation, insufficient allowance coagulation time prior to centrifugation	The tube was not inverted for 5 times  The recommended 30 min standing time for coagulation was not observed	Invert the tube for 5 times  Wait for 30 minutes before centrifugation
Abnormal assay results		Poor serum quality due to haemolysis  Excessive xg-force centrifugation	Blood subject to aggressive agitation or rough handling  The tube was centrifuged above 1,500 xg	Handle tube with moderation. Invert gently. Never shake severely or agitate the tube  Set the centrifuge to a maximum of 1,500 xg xg-force



## Blood collection tubes with pierceable and re-sealable rubber caps

Manufactured from transparent polypropylene. Robust and resistant to breakage. Tubes feature a unique flexible rubber cap which has two cross cuts and is specially designed to reseal automatically after introduction or withdrawal of the sample. **This system eliminates the need to remove the stopper when introducing or withdrawing blood samples.** Tubes can be used with most manual, semi-automatic and automatic blood sampling machines, and are suitable for transportation by intra hospital pneumatic systems.



code	type	description	expiration months	case quantity	case weight	case volume
621611	edta tripotassium	16 x 55 skirted for 2.0 ml	24	10 x 100	3.50	0.034
621613	edta tripotassium	13 x 80 for 2.5 ml	24	8 x 100	2.98	0.031

Pallet quantity: 50 cases.



## Special paediatrics

See speed sedimentation citrate for paediatrics in the page 88.



code	type	description	expiration months	case quantity	case weight	case volume
621610	edta tripotassium	12 x 55 for 1 ml	18	10 x 100	2.82	0.024
621101	citrate for coagulation	12 x 55 for 1 ml	15	10 x 100	2.84	0.024

Pallet quantity: 50 cases.



## Tubes for small blood volumes

Tubes intended for use by health professionals in clinical analysis laboratories and venous blood sample collection units.

Main use for collection of venous blood sample for blood cell count (cell structures at room temperature remain stable for a period not exceeding 4 hours after extraction)

Others: Obtaining plasma (for biochemical determinations in general except for triglycerides by enzymatic methods, glucose, potassium and calcium)

Recommended in paediatrics or for low blood volumes.



Accessory available under request to the sales department.



See speed sedimentation citrate for paediatrics in the page 88.

code	type	description	expiration months	case quantity	case weight	case volume
1501118	tripotassium edta	11 x 40 skirted for 1ml	18	10 x 100	2.3 kg	0.017
1501308	coagulation citrate	11 x 40 skirted for 1ml	15	10 x 100	2.3 kg	0.017
1501418	heparin	11 x 40 skirted for 0.8ml	18	10 x 100	2.5 kg	0.017
1501818	serum separator	11 x 40 skirted for 0.8ml	18	10 x 100	2.5 kg	0.017





### Anticoagulants and preservatives in containers

Available in bottles of 15 ml.

The dosage of one drop (15 ml = 300 drops) is enough for 5 ml of blood.

Both products have preservatives for stability.

Code **705000** composition: lithium heparin, phenylmercury acetate and distilled water. Prepared according ISO 6710. Heparin concentration between 12 and 30 µl for each ml of blood.

Expiry date: 24 months.

code	description	case quantity	case weight	case volume
705000	Lithium heparine 15 ml	10	0.29	0.00019

### Microhaematocrit capillary tubes

Soda neutral glass tubes with a colour-coded print for an easier identification, with sodium heparin (red) or without heparin (blue).

Supplied inside a glass tube with a plastic cap, specifying code, lot and expiry date.

Two lengths available: 70 or 75 mm (± 0,5 mm).



code	description	external diameter	volume µl	case quantity	case weight	case volume
161364	75 mm with heparin	1.4-1.7	75	10 x 100	0.36	0.0006
160264	75 mm without heparin	1.4-1.7	75	10 x 100	0.36	0.0006
161464	70 mm with heparin	1.5-1.6	70	10 x 100	0.36	0.0006
161964	70 mm without heparin	1.5-1.6	70	10 x 100	0.36	0.0006

### Capillary tubes sealing wax

Vinyl plastic wax, in a numbered (from 1 to 24) plastic holder.

Suitable for all capillary tubes, specially for those that have to be centrifuged, like micro-haematocrit capillary tubes.

Must be preserved in temperatures from 15 °C to 30 °C.



code	description	case quantity	case weight	case volume
140064	sealing wax	3	0.07	0.0002



## Spectrophotometer cuvettes

Disposable cuvettes suitable for most of the open spectrophotometers. Homogeneous dimensions, specially of the surface crossed by the light beam, assuring an optimum transmission level on the whole visible spectral. The material used avoids any possible measurement interference. Due to the strict quality control during the manufacture process, a high reliability is assured. The maximum absorption variations are  $\pm 1\%$ .

The two sides not crossed by the light beam are ribbed to an easy identification of the cuvette position inside the spectrophotometer measurement chamber, resulting in an easy positioning and removal.

They are supplied in a dust proof, expandable polystyrene box (100 units per box) with lid.

**Dimensions:** 12.55 x 12.65 x 44.55 mm ( $\pm 0,1$  mm).

Light path: 10 mm.

### Standard cuvettes

Made of polystyrene for assays in the visible spectral range (340 to 800).



	code	description	case quantity	case weight	case volume
1	<b>302000</b>	4.5 ml macro	5 x 100	1.60	0.020
2	<b>302100</b>	1.5 ml micro	5 x 100	1.60	0.018
3	<b>302400</b>	2.5 ml semimicro	5 x 100	1.40	0.018



### Special UV grade cuvettes

Made of UV grade PMMA for accuracy throughout UV/Vis range (280 to 800).

Model **303100** with four clear sides is ideal for fluorometry and nephelometry.



	code	description	case quantity	case weight	case volume
4	<b>303100</b>	4.5 ml 4 sides transparent	5 x 100	1.60	0.018
5	<b>303102</b>	4.5 ml macro	5 x 100	1.60	0.018
6	<b>303101</b>	2.5 ml semimicro	5 x 100	1.65	0.015
7	<b>303103</b>	1.5 ml micro	5 x 100	1.82	0.019



### Cap

Suitable for the macro cuvettes, 4.5 ml (**302000**, **303100**, and **303102**).

In polyethylene.



	code	description	case quantity	case weight	case volume
8	<b>304000</b>	polyethylene cap	1,000	0.20	0.002



Please see our rack for the spectrophotometer cuvettes, code **M-100**, on chapter **Sample Storage**.



## Sample cups

Polystyrene cups. For caps, please contact sales department.

mod.	code	capacity	type	Ø ext. mm	height mm	case quantity	case weight	case volume
1	900024	0.50 ml	Gemsaec, Kone Lab 20	13.55	24.50	10 x 1,000	13.82	0.066
2	900023	0.25 ml	Centrifichem	13.70	16.40	14 x 1,000	15.00	0.070
3	900022	1.50 ml	Technicon	13.80	22.60	10 x 1,000	10.60	0.067
4	910022	2.00 ml	Technicon	13.75	24.90	10 x 1,000	10.92	0.068

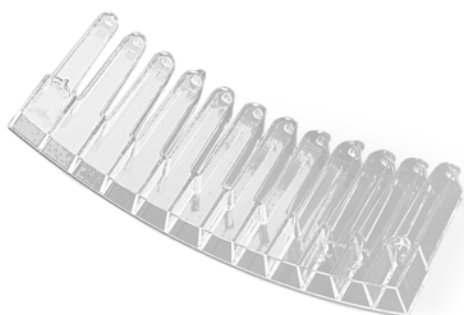

## Cobas Mira cuvette segments

Multicuvettes made of PMMA.  
Rack made of polypropylene (colour: red).  
For use on Cobas Mira.  
Light path: 6 mm.  
Complete rack with 15 segments of 12 cuvettes.



code	description	case quantity	case weight	case volume
900019	complete rack: 15 segments of 12 cuvettes	30	9.00	0.041

## "Fast read" plate for urinary sediment cell count

Disposable plate for determining  $\mu\text{L}$  cells in the sample.  
Using this system a smaller number of epithelial cells present in each field can be achieved, reducing the possibility of overlapping with other cells. Ensures a more careful and precise result, providing technical staff to determine presence of cellular elements.



code	description	case quantity	case weight	case volume
141746	fast read plate for urinary sediment cell count	100	0.30	0.0008

## Sample cups

Cups are made of polystyrene, except code **900008** which is made of HDPE.  
Also available under request the 1.5 cup Amelung type with stain ball and the 0.5 cup Sysmex type.

mod.	code	capacity	type	Ø ext. mm	height mm	case quantity	case weight	case volume
1	<b>900020</b>	2.50 ml	Hitachi	16.75	38.0	6 x 1,000	11.01	0.071
2	<b>900008</b>	0.70 ml	Cobas bio	7.65	35.5	12 x 1,000	8.40	0.067
3	<b>910023</b>	4.00 ml	Technicon	16	37.9	6 x 1,000	12.20	0.069
4	<b>910026</b>	0.5 ml (0.8 ml total volume)	Sysmex	10 / 7.5 (± 0.2)	30	10 x 2,000	11.02	0.061



## Scintillation vials

Single use vials made of high density polyethylene to minimize solvent losses.  
Screw caps made of polypropylene ensure a leakproof seal.  
Compatible with most liquid scintillation counters available on the market.  
2 models available: code **900100**, standard volume 20 ml, and code **900101**, volume 4 ml, designed for insertion in the 20 ml vial so as to minimize the volume of scintillation liquid.

### Dimensions:

Vial 20 ml: 26.5 x 60.10 mm (Ø x h)

Minivial 4 ml: 13.71 x 53.60 mm (Ø x h).



code	description	case quantity	case weight	case volume
<b>900100</b>	scintillation vial (20 ml)	1,000	7.90	0.069
<b>900101</b>	minivial (4 ml) for the above vial	2,000	5.90	0.041



## Coulter counter cups

Coulter counter cups: single use polystyrene cups suitable for any Coulter.  
Two models available, with or without lid. Volume: 20 ml.  
Dimensions: 30 x 56 mm (Ø x h).

code	description	case quantity	case weight	case volume
<b>200103</b>	coulter counter cup with lid	1,000	7.80	0.090





# 04. HISTOLOGY, MICROSCOPY AND STAINING





### Polyethylene wide mouth jars with lid and insert plug

High density Polyethylene jars with screw cap and insert plug. Jars and plugs are natural translucent; lids are black. Upon request, jars can be supplied individually wrapped for a minimum order of 3 cases for each code, and sterile for a minimum order of 6 cases, for each code.



code	capacity ml	Ø neck mm	Ø base mm	height mm	alimentary use	case quantity	case weight	case volume
202810	60	38	52	48		200	3.90	0.045
202809	125	51	60	62	✓	200	6.00	0.082
202802	250	54	67	100	✓	125	4.85	0.078
202814	400	60	74	124		130	8.00	0.140
202803	500	67	80	131	✓	120	7.70	0.140
202821E.1	500	86	103	93	✓	144	8.31	0.140
202813	750	86	103	127	✓	75	4.56	0.152
202818	1.000	86	103	157	✓	50	5.43	0.140



See more capacities on pages 288-289

### Jars with lid

Body and lid in white **autoclavable** polypropylene. Self sealing security lid. Made with materials suitable for food use. Code **241013, 241014 and 241015** embody a plastic handle. Jars are supplied uncapped.



code	nominal capacity ml	Ø int. mouth x Ø base x height mm	weight g	case quantity	case weight	case volume	cases pallet
241010	250	84 x 79 x 61	13	150	3.04	0.042	32
241011	550	107 x 98 x 79	24	250	5.01	0.103	16
241013	1,000	107 x 94 x 144	32	150	7.31	0.082	20
241014	1,560	135 x 118 x 138	48	150	4.42	0.130	16
241015	2,000	163 x 144 x 156	72	48	5.37	0.075	24

### Tamper evident, buckets with lid

Disposable containers made of **autoclavable** polypropylene. Include tight fitting and leakproof lids. All models include a sturdy and convenient white plastic handle for easier carrying. Buckets are supplied with lid apart.



code	capacity l	Ø int. mouth mm	height mm	body weight g	case quantity	case weight	case volume	cases per pallet
222802	3	184	138	105	80	9.00	0.140	16
222803	4.5	210	156	134	48	10.46	0.130	16
222804	5.6	211	194	152	45	10.79	0.140	16
222805	10.6	251	263	265	20	8.39	0.140	16

## Leak proof screw cap containers

Specially designed for histology, they are provided with double internal security closure. Manufactured in translucent polypropylene with polyethylene ribbed yellow cap. They have moulded graduations in increments of 50 ml, and a ring in the upper part of the container that prevents dripping when decanting liquids. Its leakproof closure makes them ideal for liquid (including alcohols) or solid sample storage.

They meet the standard UNE-EN 14401. Rigid plastic containers. Methods to test the effectiveness of closures.

Supplied uncapped. Check with the sales department for other colors.



mod.	code	graduated capacity (ml)	maximum capacity (ml)	max. recommended capacity (ml)	external mouth Ø mm	height mm	case quantity	case weight	case volume	cases per pallet
1	202845	150	280	200	89	57	100	4.67	0.046	32
2	202846	350	500	400	90	110	200	10.80	0.082	20
3	202847	700	1,000	800	111	139	100	10.97	0.096	16



HISTOLOGY, MICROSCOPY AND STAINING

## Security screw cap containers

Ultra clear polypropylene containers with yellow polyethylene cap.

Watertight closure: the cap, with an innovative shape, has a double closure. Graduated Container.

The base and the cap are ribbed so the handling with gloves is comfortable and reliable.

There is a ring in the upper part of the body, in order to avoid the dripping in case of liquid decanting.

Six different capacities from 20 to 120 ml.

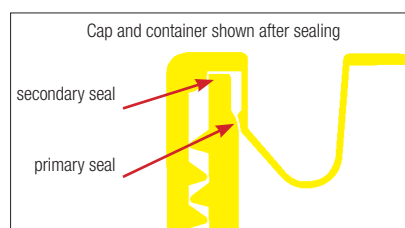

Find more information about this product on chapter **Containers. Sampling**





## Paraffin

It has a low dimethylsulphoxyde (DMSO) content and a quick penetration of tissues for 2 micron cuts.

Melting point: **56/58 °C**. Can be used with usual solvents. Ideal for histology. 1 Kg presentation.



code	description	case quantity	case weight	case volume
440139	Paraplast Plus®	8 x 1Kg	8.50	0.023
440139D	Pure paraffine with DMSO	8 x 1Kg	9.0	0.025

## Histology mould

Single use clear polypropylene mould.

The smooth interior ensures the paraffin does not adhere to the mould. The special material used ensures excellent thermal exchange. Available in various sizes. Suitable for most of the cassettes.

**External dimensions:** 50 x 37.2 x 12 mm.

mod.	code	well dimensions mm	case quantity	case weight	case volume
1	440131	15 x 15 x 5	1,000	2.20	0.013
2	440132	24 x 24 x 5	1,000	2.20	0.013

## Metal tray histology

Material: stainless steel.

**External dimensions:** 52 x 35 x 11 mm.

mod.	code	well dimensions mm	case quantity	case weight	case volume
1	192932	15 x 15 x 7	10	0.09	0.0002
-	192933	24 x 24 x 7	10	0.09	0.0002
2	192934	30 x 24 x 7	10	0.09	0.0002
3	192935	37 x 24 x 7	10	0.09	0.0002

## Tissue embedding sponge

Foam sponge, very useful for small specimens in biopsy tests.

Fits standard cassettes.

Avoids sample loss though drain holes when sample is processed.

Does not affect paraffin drainage.

code	dimensions mm	colour	case quantity	case weight	case volume
192922.04	32 x 26 x 3	blue	500	0.08	0.003

## Biopsy Bags

Used to hold small biopsy and histological specimens during processing. Manufactured from solvent resistant Polyester, effectively prevent the deformation. Thin mesh (0.2x0.2 mm) provides excellent fluid exchange and avoids small sample loss. Convenient peel-open bag allows for placing and removing specimen rapidly.

### HOW TO USE

1. Put the biopsy in the bag and fold its end
2. Place it the cassette and enclose to process as a usual processing
3. Extract the bag from the cassette
4. Open it with care extending the edges
5. Extract the sample for embedding in paraffin

code	colour	case quantity	case weight	case volume
192950	45 x 75	10 x 100	0.2	0.0025
192951	75 x 95	5 x 100	0.3	0.0020
192952	30 x 45	5 x 200	0.17	0.0010



## Cassettes without lid

Made of polyacetylene.  
With 34 round holes of 2 mm Ø.  
Resistant to the solvents used in histological processes.  
It is possible to write on them.

**External dimensions:** 40 x 28 x 6 mm.

code	colour	case quantity	case weight	case volume
440141	white	3 x 1.000	7.00	0.047
440147	green	3 x 1.000	7.00	0.047
440144	pink	3 x 1.000	7.00	0.047
440143	yellow	3 x 1.000	7.00	0.047



## Lids for cassettes

Stainless steel lids. Fit all standard cassettes.  
Suitable for **440141** and series.

code	description	case quantity	case weight	case volume
440149	lid for cassettes	25	0.07	0.0006



## Cassette for biopsy 6 compartments

Material: polyacetylene. Designed for small biopsies, each cassette has six individual cells to hold six samples.  
Each cell is 7 x 12 mm. The lid allows multiple opening and closing.  
A frosted area allows writing on the cassette.  
Each cassette has near 3,000 micro holes of 0.26 mm diameter.



code	colour	case quantity	case weight	case volume
44240	pink	4 x 250	5.20	0.026
44245	blue	4 x 250	5.20	0.026

Ask for minimum quantity and delivery time of other colours.





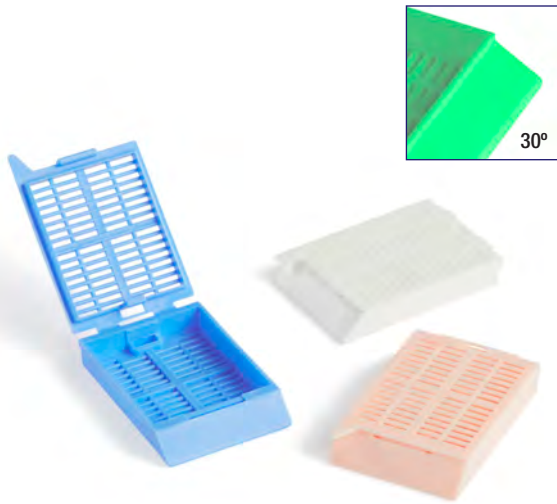

### Cassettes for tissue

Made of acetal polymer. With an integral lid.  
**Hand and automatic cassettes.**  
Small tab on the lid for easy opening and locking.



code	colour	case quantity	case weight	case volume
554141	white	4 x 500	7.90	0.064
554147	green	4 x 500	7.58	0.064
554140	pink	4 x 500	7.58	0.064
554148	blue	4 x 500	7.58	0.064

Ask for minimum quantity and delivery time for other colours.

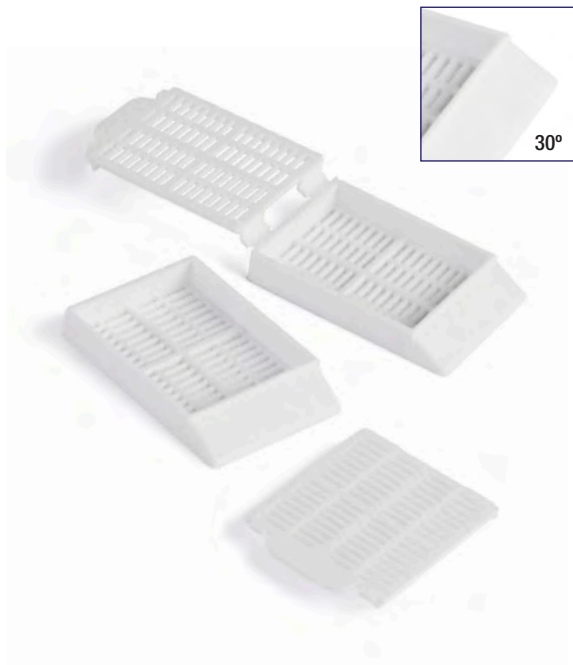

### Cassettes for tissue. Histosette I

- Made of polyacetal.
- Air vents allowing more efficient filling with paraffin.
- Safety closure.
- With one-piece integral lid.
- To lock the cassette, just separate apart the lid, turn it round and lock it into the base of the cassette.
- They may be opened and closed as many times as required.
- **External dimensions:** 40 x 28 x 6 mm (with closed lid).

Writing area at 30°. **Hand cassettes.**  
64 cuts (1 x 5 mm) in base and lid, distributed 16 x 4



code	colour	case quantity	case weight	case volume
454141	white	3 x 500	5.40	0.039
454147	green	3 x 500	5.40	0.039
454140	pink	3 x 500	5.40	0.039
454148	blue	3 x 500	5.40	0.039

Ask for minimum quantity and delivery time for other colours.



### Biopsy cassettes. Histosette I

Frontal writing area at a 30° angle. **Cassettes for manual use.**  
Material: Acetal  
Designed to hold biopsy specimens during the embedding process, as well as in a storage folder.



code	colour	case quantity	case weight	case volume
454241	white	1,500	5.74	0.037

### HOW TO USE

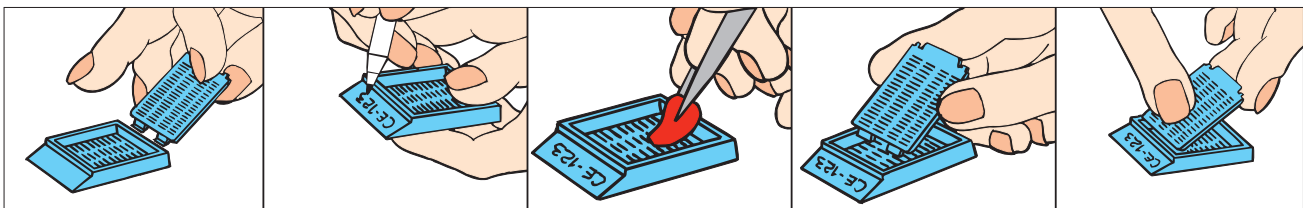

## Mega cassettes

Made from polyacetal.  
With an integral lid.  
Designed for larger tissue samples.  
Holes are 1 x 5 mm.  
**Cassette dimensions:** 26 x 40 x 13 mm.



code	colour	case quantity	case weight	case volume
44125	white	500	2.57	0.025

Ask for minimum quantity and delivery time for other colours.



## Cassettes for tissue. Histosette II

- Made of polyacetal.
- Hinged lid: can be opened and closed as often as necessary.
- Supplied assembled, saving time and making storage easier.
- Air vents allowing more efficient filling with paraffin.
- Easy handling with one hand.
- Safety closure (see figure).
- Writing area slanted at a 45° angle, suitable to be used with most labelling instruments.
- **External dimensions:** 41 x 28 x 6 mm.

64 cuts in base and lid. **Hand and automatic cassettes.**  
Cassettes and lids are available: pre-mounted, or with the lid separated in another case.



code	colour	case quantity	case weight	case volume
<b>Cassettes with the lid pre-mounted:</b>				
44140	pink	3 x 500	5.00	0.026
44141	white	3 x 500	5.00	0.026
44143	yellow	3 x 500	5.00	0.026
44145	blue	3 x 500	5.00	0.026
44147	green	3 x 500	5.00	0.026

\*2 dispensing boxes with 500 cassettes each plus one box containing 1.000 lids.



## Cassettes for biopsy. Histosette II

Made of acetal polymer. 224 holes. 1 mm square openings to maximize fluid exchange and to ensure proper drainage. **Hand and automatic cassettes.**  
Cassettes and lids are available: pre-mounted, or with the lid separated in another case.



Security closure



code	colour	case quantity	case weight	case volume
<b>Cassettes with the lid pre-mounted:</b>				
445140	pink	3 x 500	5.20	0.026
445141	white	3 x 500	5.20	0.020
445143	yellow	3 x 500	5.20	0.026
445145	blue	3 x 500	5.20	0.026
445147	green	3 x 500	5.20	0.026

\*2 dispensing boxes with 500 cassettes each plus one box containing 1.000 lids.

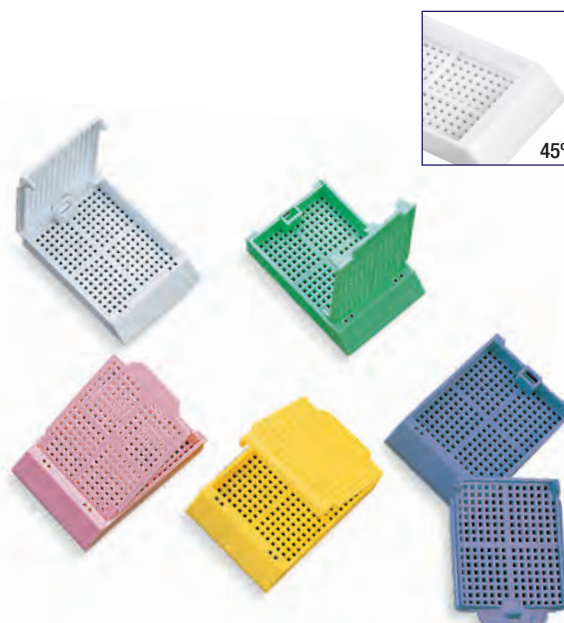



## Biopsy cassettes

**Recommended for THERMO printers.**

Manufactured in POM, resistant to the chemical action of the solvents used in histology. Available for biopsy, with 0.9mm square holes, and for fabrics, with 0.5x1mm rectangular holes.

With 2 large marking areas on the sides and another on the front, 45°. The hinge design ensures that the cassette and its lid are always attached even if it is opened and closed frequently, avoiding any loss of the sample. Supplied in 10 sleeves of 75 cassettes plus 1 zip bag with 750 caps.

For other colors, check with the sales department.



code	type	colour	case quantity	case weight	case volume
555260	for biopsy	white	750	3.08	0.015

## Biopsy and tissue cassettes

**Recommended for LEICA & SAKURA, PRIMERA and SAKURA TISSUE-TEK SMARTWRITE printers.**

Manufactured in POM, resistant to the chemical action of the solvents used in histology. Available for biopsy, with 1.6mm square holes, and for tissues, with 0.5x1mm rectangular holes.

With 2 large marking areas on the sides and another on the front, 35°. One piece design and snap closure. Supplied in 25 sleeves of 40 cassettes, with open lid.

For other colors, check with the sales department.



code	type	colour	case quantity	case weight	case volume
555262	for biopsy	white	1,000	4.15	0.019
555264	for biopsy	white	1,000	4.26	0.019
555265	for tissue	white	1,000	3.96	0.019

## Biopsy and tissue cassettes

Made of POM, resistant to the chemical action of solvents used in histology. Measurements: 28 x 40 x 7mm.

Available for biopsy, with rectangular holes of 5.0 x 1.0 mm.

Available for tissue, with square holes of 0.9 x 0.9 mm.

With two large labelling areas on the sides of the cassette and a front writing surface inclined at a 45° angle, adaptable to most cassette labellers. Colour: white.

Compatible (not exclusive) with: Leica IPC®, SAKURA®(Leica OEM), Laser printer® (UV type) y Vogel® (needle).



	code	description	type	case quantity	case weight	case volume
1	440161	biopsy cassette with lid	stack	2,000	9.00	0.35
1	440171	disassembled lid cassette for biopsy	tower	3,000	13.00	0.58
2	440181	cassette with lid for fabrics	stack	2,000	9.00	0.35
2	440191	cassette cover removed for fabrics	tower	3,000	13.00	0.58

For other colours, please contact the sales department.



## Laboratory storage cabinet

Designed especially for the storage of microscope slides, histology cassettes and embedding rings. Universal models interchangeable with other cabinets on the market. All parts of the cabinet are stackable. Manufactured from enameled metal. Colour grey. You can make up your own composition from one or several of the following elements:

- Modular cassette drawers
- Modular microscope slide drawers
- Top
- Base
- Wheels base

All modules are stackable.

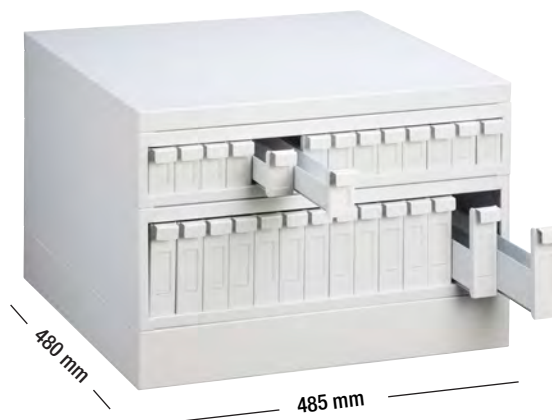

### Modular top (1)

code	external dimensions mm			unit weight	unit volume
	height	length	width		
DS51	26	485	480	2.18	0.007



### Modular cassette drawers (2)

Cabinet consisting sliding drawers.  
The cabinet can hold approximately 910 embedding rings.

code	external dimensions mm			unit weight	unit volume
	height	length	width		
DS36	91	485	480	9.56	0.033



### Modular microscope slide drawers (3)

Consisting of 14 sliding drawers to hold a total of approximately 5,600 microscope slides of 26 x 76 mm.

code	external dimensions mm			unit weight	unit volume
	height	length	width		
DS10	146	485	480	12.50	0.044



### Modular base (4)

To fit all modular cabinets and drawers.

code	external dimensions mm			unit weight	unit volume
	height	length	width		
DS52	76	485	480	1.59	0.019



### Modular base with wheels (5)

To fit all modular cabinets and drawers.

code	external dimensions mm			unit weight	unit volume
	height	length	width		
DS63	146	485	480	9.24	0.070





## Forceps

Made of polyoxymethylene. Colour: orange.  
Self-sprung forceps with rounded ends.  
Code **19503**, the inner part of the tip is ribbed to enhance sampling. Ribbed for a better handling.  
**Autoclavable.** Flexible.



code	length mm	case quantity	case weight	case volume
19500	115	5	0.23	0.0006
19501	145	5	0.05	0.0001
19503	250	5	0.17	0.0043



## Economical storage box

This box, complete with a lid, is specially designed for the storage of histology cassettes.  
Made of heavy-duty cardboard for long term storage.  
Each box stores up to 250 cassettes or 160 embedding rings.

**Dimensions:** 455 x 235 x 50 mm.

code	description	case quantity	case weight	case volume
DS42	waterproof cardboard	18	5.30	0.130

## Modular storage drawers

Made of high impact polystyrene, this set consists of 6 stackable drawers (7 slots per drawer) providing permanent storage and identification of up to 165 embedding rings or 250 cassettes per drawer (total capacity: 1,500 cassettes).

**Dimensions:** 400 x 230 x 340 mm.  
Front: black colour. Sides: grey.

code	description	case quantity	case weight	case volume
DS40	set of 6 drawers	1	6.00	0.034



## Slides

**Standard size:** 26 x 76 mm (± 0.2 mm)

**Thickness:** 1.1 mm (± 0.1 mm)

Clear, **pre-washed glass**. Ideal for routine analysis.

Displayed in cases of 50 units.

Each case is vacuum flow-packed to protect them from dirtiness.

Each case includes a bag of silica salt. With improved matte band for greater comfort of use: it offers better writing and prevents the slides from sticking together.

**Available with polished or cut edges of 45° and 90°.**

**Expiry date:** 24 months.

	code	edges	angle	corners	matte area	case quantity	case weight	case volume
A	D100001	cut	90°	non clipped	no	50 x 50	14.25	0.014
B	D100002	grounded	45°	clipped	no	50 x 50	14.20	0.010
C	D100003	cut	90°	non clipped	yes	50 x 50	14.25	0.014
D	D100004	grounded	45°	clipped	yes	50 x 50	14.25	0.014
E	D100005	grounded	90°	non clipped	no	50 x 50	14.20	0.014
F	D100006	grounded	90°	non clipped	yes	50 x 50	14.20	0.014

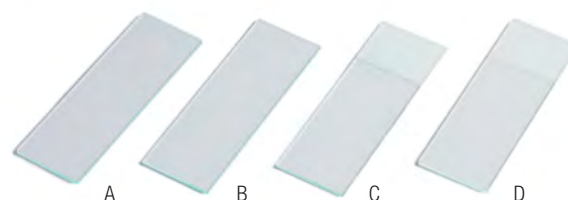

## Cover slides

**Standard size:** Different according each model. (Please check the table below)

**Thickness:** 0.145 mm (± 0,015 mm)

Clear, **pre-washed glass**.

Specific use: protection of the sample and lens.

Supplied in cases of a hundred or two hundred units (depending on the code).

Each case includes a bag of silica salt, and is supplied vacuum in tropical pack.

Easy opening, no need for scissors. New improved box which minimize the risk of pack breakage and ensure a better lock.

code	dimensions mm	case quantity	case weight	case volume
D101818	18 x 18	5 x 200	0.30	0.0012
D102020	20 x 20	5 x 200	0.33	0.0011
D102222	22 x 22	5 x 200	0.37	0.0012
D102240	22 x 40	10 x 100	0.65	0.0016
D102424	24 x 24	5 x 200	0.41	0.0011
D102432	24 x 32	10 x 100	0.63	0.0017
D102440	24 x 40	10 x 100	0.68	0.0017
D102450	24 x 50	10 x 100	0.79	0.0017
D102460	24 x 60	10 x 100	0.89	0.0017





## STAR FROST® ADHESIVE slides

**Standard size:** 26 x 76 mm (± 1 mm).

**Thickness:** 1 mm (± 0,05 mm).

High definition, **pre-washed glass.**

**Hydrophobic.** No stain residues, no proteins in the surface.

**Grounded edges.**

**Marking area: Featuring a 20 mm wide section.** This special printed area is resistant to all common chemicals used in the laboratories, and may be marked with pencil, ballpoint pen, marker and different laboratory-printers (e.g. Leica XPS). Thanks to the single side printing the user always knows the best surface to be used.

StarFrost® Adhesive slides do not show striae and disturbing background staining such as the blue or red background obtained with Haematoxylin and Eosin-staining of tissues on Albumin coated glass, or the brown background obtained during the Immunoperoxidase or In-situ-DNS-Hybridisation process. They are ideal for molecular-hybridization, as being DNase and RNase free there is no need of washing them with chromic acid. **Available with ground edges 90°.**

Supplied in boxes of 50 units.

The final packaging (20 boxes) is protected by an aluminum film packaging that protects against humidity (**tropical pack**).

Complies with ISO 8037/1 (European standard). **Expiry date:** 14 months.

Star Frost® Adhesive slides are treated with silane-coating, which ensures cell-and-tissue-adhesion and supports the forming of covalent bonds between the tissue and the glass surface through electrostatic attraction. So tissue and cell substrates stick rapidly on the surface without using further adhesives or protein coating media, saving costs and time. As the underside is untreated, the Star Frost® Adhesive slides do not tend to stick when stacked or transported as with other competitive products.



code	angle	corners	case quantity	case weight	case volume
A100018	90°	non clipped	20 x 50	5.02	0.004
A100019	45°	clipped	20 x 50	4.98	0.004

## STAR FROST® slides

**Standard size:** 26 x 76 mm (± 1 mm). Made in Germany.

**Thickness:** 1 mm.

High definition, **pre-washed glass.**

**Hydrophilic** (epoxy).

Featuring a colour-coded, 20 mm **marking area.**

This special colour-printed area is resistant to all common chemicals used in the laboratories, and may be marked with pencil, ballpoint pen, marker and different laboratory-printers (e.g. Leica XPS). Thanks to the single side printing the user always knows the best surface to be used.

**Ground edges at 45° (angle) and clipped corners.**

Supplied in boxes of 50 units.

Final package (20 boxes) by tropical pack. **Expiry date:** 14 months.



code	strip colour	case quantity	case weight	case volume
A100010	white	20 x 50	4.94	0.003
A100011	green	20 x 50	4.98	0.004
A100013	blue	20 x 50	4.94	0.004
A100014	yellow	20 x 50	4.94	0.003



## Slide printer microscope slides

**Measures:** 25 x 75mm

**Thickness:** 1.1mm

Made of clean, clear, degreased glass with polished edges and frosted white, hydrophilic, clean and washed marking area. Resistant to all common laboratory chemicals, high pH, routine stains, etc. and suitable for all common sterilization methods. It is possible to mark with pen, pencil and laboratory marker.

Suitable for manual use and use in printers such as Thermo Slide-Mate® (Thermo-Fisher) slide printer & Signature® (first) slide printers.

For other colour, ask to the sales department.

**Expiry date:** 18 months

code	angle	corners	mat area	case quantity	case weight	case volume
D100010	45°	clipped	yes	50x50	14.2	0.014
D100011	90°	non clipped	yes	50x50	14.2	0.014



## Adhesion microscope slides

**Measures:** 25 x 75mm

**Thickness:** 1.1mm

Made of super white glass with positive charge coating specially developed for use in immunohistochemistry (IHC) and other more complex applications. It offers a great adhesion of the tissue on the surface of the slide. In addition, it also improves staining itself. Hydrophilic surface tension and grounded edges.

Suitable for use in manual IHC staining, automatic IHC staining with Leica and Dako automated IHC Stainers and routine H&E staining of detachable tissue sections.

Models D100024 and D100025 are also recommended for Roche Ventana automated IHC Stainer.

**Expiry date:** 15 months

code	angle	corners	mat area	case quantity	case weight	case volume
D100018	90°	non clipped	yes	72x20	8.5	0.009
D100019	45°	clipped	yes	72x20	8.5	0.009
D100024	90°	non clipped	yes	72x20	8.5	0.009
D100025	45°	clipped	yes	72x20	8.5	0.009





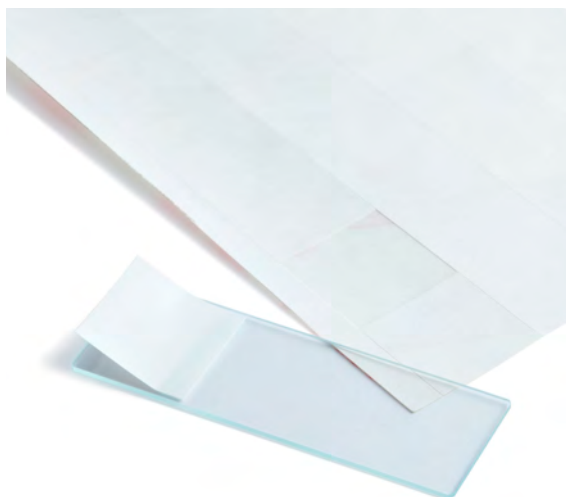

### Microscope slide labels 23 x 23 mm

Write on these permanent adhesion labels and stick them onto microscope slides for better identification.

White colour.

Each sheet contains 40 labels (8x5).

Page size: 13.3 x 19 cm.

code	quantity	weight	volume
901600	1,000 labels	0.14	0.0001

### Mounting medium for microscopy

VITROCLUD® quick-hardening mounting medium for microscope preparations. Neutral and colourless.

Short hardening time (20 min). Refractive index at room temperature: 1.5. Resistant to heat, cold (down to -17 °C), humidity and light including UV rays. It is recommended to close the container immediately after use.

If the medium becomes too viscous, add Xylene.

Supplied in aluminum bottles for a safer storage.

Store at maximum 20 °C.

code	description	case quantity	case weight	case volume
A20100	bottle 100 ml	1	0.13	0.0003
A20250	bottle 250 ml	1	0.30	0.0016
A20500	bottle 500 ml	1	0.58	0.0020

### Staining tray

Made of ABS.

It will accept 10 or 20 slides on plastic rails covered by a polymer strip to perfectly hold slides even if tray is held at an angle (see picture A).

When humidity is required, wells between rails may hold water, and raised rails will avoid water from touching the slides.

It features a draining plug to ease the emptying of the tray (see picture B). Four rubber feet ensure stability.

Cannot be used with acetone and chlorinated hydrocarbons.

code	description	lid colour	case quantity	case weight	case volume
989953	staining tray 10 slides	black	1	0.65	0.003
989951	staining tray 20 slides	transparent	1	1.01	0.005
989952	staining tray 20 slides	black	1	1.08	0.050



## Stains

code	description	volume	dangerousness	hazardous	CE certificate	case quantity	case weight	case volume
<b>May Grunwald solution</b>								
808000	Eosin	250 ml	H225, H331, H311, H301, H370	ONU 1992. ADR: 3/6.1/II. IMDG: 3/6.1/II. IATA: 3/6.1/II. PAX: 352. CAO: 364		CE IVD	16	4.80 0.015
808001	Eosin	1,000 ml	H225, H331, H311, H301, H370	ONU 1992. ADR: 3/6.1/II. IMDG: 3/6.1/II. IATA: 3/6.1/II. PAX: 352. CAO: 364		CE IVD	12	13.00 0.045
<b>Giemsa solution</b>								
808100	Eosin	250 ml	H225, H331, H311, H301, H370	ONU 1992. ADR: 3/6.1/II. IMDG: 3/6.1/II. IATA: 3/6.1/II. PAX: 352. CAO: 364		CE IVD	16	5.15 0.015
808101	Eosin	1,000 ml	H225, H331, H311, H301, H370	ONU 1992. ADR: 3/6.1/II. IMDG: 3/6.1/II. IATA: 3/6.1/II. PAX: 352. CAO: 364		CE IVD	12	13.00 0.045
<b>Wright stain</b>								
808200	Eosin	250 ml	H225, H331, H311, H301, H370	ONU 1992. ADR: 3/6.1/II. IMDG: 3/6.1/II. IATA: 3/6.1/II. PAX: 352. CAO: 364		CE IVD	16	4.43 0.015
<b>Gram stain</b>								
Kit 805000	806030	Lugol	250 ml	-	-	-	16	4.90 0.015
	805040	Gentian violet	250 ml	-	-		16	4.80 0.015
	805001	Gram decolorizing	250 ml	-	-		16	4.25 0.015
	805050	Safranin solution	250 ml	H226	ONU 1993. ADR: 3/III. IMDG: 3/III IATA: 3/III		-	16
805001	Gram decolorizing	250 ml	H225, H319, EUH066, H336	ONU 1993. ADR: 3/II. IMDG: 3/II. IATA: 3/II. PAX: 353. CAO: 364		-	16	4.25 0.015
806030	Lugol Iodine	250 ml	H412	-	-	-	16	4.90 0.015
805040	Violet crystal solution	250 ml	H302, H351, H318, H410	-		-	16	4.80 0.015
805140	Violet crystal solution	1,000 ml	H302, H351, H318, H410	-		-	12	13.00 0.045
<b>Ziehl stain</b>								
805050	Safranin solution	250 ml	H226	ONU 1993. ADR: 3/III. IMDG: 3/III IATA: 3/III		-	16	4.80 0.015
805150	Safranin solution	1,000 ml	H226	ONU 1993. ADR: 3/III. IMDG: 3/III IATA: 3/III		-	12	13.00 0.045
805120	Ziehl fuchsin solution	1,000 ml	H225, H312, H302, H319, H315, H341	-		-	12	13.00 0.045
805030	Methylene blue	250 ml	H302	-		-	16	4.80 0.015
805130	Methylene blue	1,000 ml	H302	-		-	12	13.00 0.045
805013	Fast stain for blood extensions, Kit with 2 containers of each type containers stain B	250 ml	-	-	CE IVD	12 Kits	14.95	0.045

Minimum order quantity: 1 bottle or kit. Check with the sales department for special transport conditions.



## Staining jars with lid

Material: **autoclavable TPX**.

Two options available: vertical, "Hellendhall" type (Code **19335**) horizontal "Schiffertecker" type (Code **19351**).

It is recommended to use slides up to 2 mm thick.



code	description	case quantity	dimensions mm	case weight	case volume
<b>19355</b>	vertical, for 8 slides	4	58 x 53.5 x 86	0.28	0.002
<b>19351</b>	horizontal, for 10 slides	4	76 x 65 x 45	0.32	0.002

## Staining jar and dish

Dish made of polypropylene and jar made of **autoclavable TPX**. The jar is supplied with two lids. The first lid provides evaporation free storage of staining liquid when the dish is not in use. The second includes a slot to allow staining dish insertion.

Code **19353**: height (with lid) 70 mm, height (without lid) 65 mm, length 100 mm and width 75 mm.

Code **19354**: height 21 mm, length 83 mm, width 70 mm and length (handle) 160 mm.

It is recommended to use slides up to 1 mm thick.



code	description	case quantity	case weight	case volume
<b>19353</b>	jar with 2 lids	4	0.49	0.006
<b>19354</b>	staining dish for 20 slides	2	0.06	0.001

## Staining system

Slide staining system compound of a range of jars, and a 12 slides staining rack. Different jar colours allow the user to distinguish each stage of the staining process. Jar and rack made of **autoclavable** POM (polyoxymethylene), resistant to staining agents as alcohol, xylene, etc. (not phenol). The jar embodies a hinged lid which allows storing the jar with the content. Reagent capacity: 80 ml.

Jars can be loosely joined to each other laterally (picture 1).

The rack features a handle in the hinged lid, and can be placed up when handled out of the jar. Since the slides are placed vertically in the rack, their writing area will not be stained, allowing their removal without the use of forceps (picture 2).

Rack and jar withstand from **-170 °C** and **121 °C**.

**Jar dimensions:** 64 x 76 x 92 mm.

**Rack dimensions:** 60 x 64 x 97 mm.



code	description	case quantity	case weight	case volume
191104	blue jar	6	0.72	0.0059
191105	green jar	6	0.78	0.0059
191106	white jar	6	0.68	0.0059
191107	yellow jar	6	0.68	0.0059
191108	dark grey rack	6	0.32	0.0024





### Coplin type staining jar

Jar made of opaque white, unbreakable and **autoclavable** polypropylene, designed for staining 5 standard microscope slides.

Rectangular container with rounded base and screw ribbed flat cap with an inner ring for preventing leakage.

Used as a storage system, it can hold up to 10 slides (2 per groove).

**Dimensions:** Base diameter: 60 mm.

Height of jar: 110 mm. Height of jar with cap: 114 mm.

It is recommended to use slides up to 1.1 mm thick.



code	description	case quantity	case weight	case volume
191087	coplin jar for 5 slides	12	0.92	0.007



HISTOLOGY, MICROSCOPY AND STAINING



### Staining jar

Code **19360** is a stainless steel staining jar.

With a lid to avoid evaporation.

Includes an adjustable handle for more convenience.



code	description	dimensions mm	case quantity	case weight	case volume
19360	jar	115 x 88 x 77	1	0.42	0.001

### Staining racks

Stainless steel.



code	description	case quantity	case weight	case volume
S-004	for 12 slides length: 435 mm. width: 85 mm	1	0.25	0.003
S-003	without dividers length: 435 mm. width: 85 mm	1	0.21	0.003

## Slidefolders

Available in 2 materials, in polystyrene or in cardboard. They can contain 20 standard slides.

Polystyrene model: The base containing the slides is numbered from 1 to 20. Resistant from **-80 °C to 100 °C**.

Not autoclavable. The transparent cover, by way of two windows, is foldable. Very easy opening. The two covers being closed, for the protection of the slides. The identification of the sample labels can be seen perfectly. For the protection of the slides the two covers may be closed.

The slides are easily removed by pressing with one finger on the side. Stackable.



code	External dimensions mm	material	colour	case quantity	case weight	case volume
989945	192 x 292 x 11	PS	blue	10	3.20	0.013
989919	205 x 340 x 9	paperboard	white	50	15	0.037

\* Minimum unit of sale 5 units.

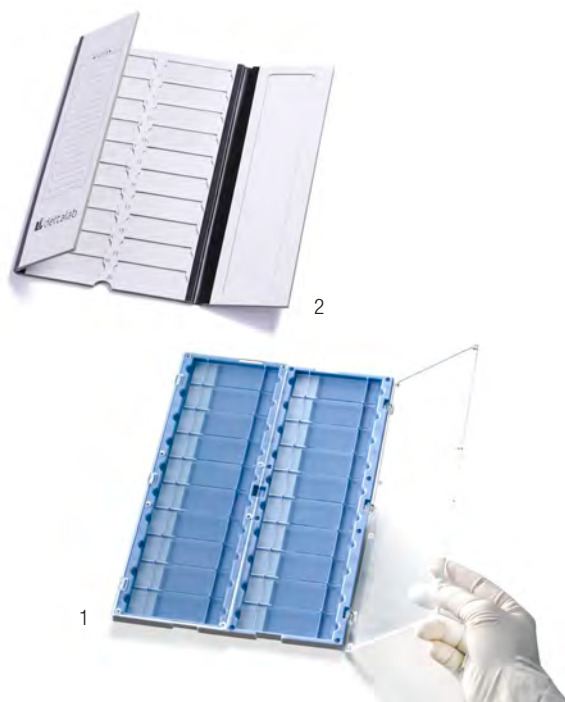

## Slide tray

Made of high impact polystyrene. It will hold up to twenty standard slides. The slide tray is easily stackable and will take minimum space on any shelf or laboratory counter.

Not autoclavable.

**External dimensions:** 206 x 299 x 18 mm.



See our slides on pages 107-109



code	colour	case quantity	case weight	case volume
989956	white	10	0.91	0.013



## Slide trays

Very light polystyrene trays.

White colour.

Stackable



code	description	dimensions mm	case quantity	case weight	case volume
989910	slide tray for 10 slides	100 x 340 x 17	40	2.50	0.015
989921	slide tray for 20 slides	194 x 297 x 12	20	4.30	0.013



## Slide mailer

Made of polypropylene. Designed for slide transport and protection. To send by mail we recommend to use special envelopes.  
Compartment shape ensures tight fit: no risk of damaging slides.  
Easy snaplock, but not indicated for liquid samples.

mod.	code	material	slide capacity	dimensions mm (length x width x height)	case quantity	case weight	case volume
1	19923	PP	1	80 x 40 x 6	50	0.33	0.002
2	900025	PP	2	87 x 47 x 16	100	1.27	0.010
3	979930	PP	2	84 x 71 x 6	250	3.98	0.010
4	19924	PP	3	84 x 99 x 6	10	3.30	0.001
5	900028	PP	5	82 x 17 x 29	100	1.02	0.012



## Slide tube mailer

Tube in polypropylene for mailing, staining and storing of 4 standard slides.  
Leakproof cap made of high density polyethylene in pink colour.  
Incorporates a **tamper evident locking mechanism** that can be activated whenever user decides.  
The cap has one space to insert a colour disc as identification (**40911A**, chapter 6. Tubes and microtubes).  
Being transparent helps the user to notice if there are slides in it, an advantage in front of the popular white transparent tubes.  
Internal volume: 12 ml.

**Dimensions:** 35 x 87 mm (external). Internal diameter: 27 mm



code	description	case quantity	case weight	case volume
19926	tamper evident tube	100	2.00	0.018

## Slide storage boxes

Manufactured in ABS, beige or blue colour. Economical boxes to store or transport 25, 50 or 100 slides.

Safe closing and easy opening.

They include numbered sheets with a labeling space in the bottom of the case and in the inner side of the cover (excepting model 1, which does not include the one in the inner side of the cover).

Models 2 and 3 have a special design assuring a good stability when stacked.

**It is recommended to use slides up to 2mm thick.**

mod. 2, 3



mod.	code	slide capacity	colour	stackable	minimum order quantity	dimensions mm	case quantity	case weight	case volume
	<b>19276.B</b>	beige slide box for 25 slides	●		5	93 x 87 x 32	200	10.61	0.071
1	<b>19276.A</b>	blue slide box for 25 slides	●		5	93 x 87 x 32	200	10.61	0.071
2	<b>19277.B</b>	beige slide box for 50 slides	●	✓	2	200 x 89 x 32	100	11.28	0.071
3	<b>19278.B</b>	beige slide box for 100 slides	●	✓	5	200 x 170 x 32	50	11.85	0.071
	<b>19278.A</b>	blue slide box for 100 slides	●	✓	5	200 x 170 x 32	50	11.85	0.071



## Cylindrical slide mailer

Polypropylene. Ideal for storing and transporting 5 to 10 slides in complete safety. The deep threaded container provides a leakproof seal for transport.

**It is recommended to use slides up to 1.2 mm thick.**



code	description	case quantity	case weight	case volume
<b>19922</b>	for 10 slides	10	0,33	0,0028





### Slide storage boxes

Manufactured in **ABS** for 100 slides. The internal cork lining prevents damage to stored slides. To ensure proper slide identification, each slot is numbered to correspond to the slide inventory sheet on the inside cover of the box. Stackable.

**Dimensions:** 208 x 162 x 32.

**It is recommended to use slides up to 1 mm thick.**



code	description	case quantity	case weight	case volume
19278.2	red, for 100 slides	1	0.37	0.002
19278.3	white, for 100 slides	1	0.37	0.002

### Microscope slide boxes

Made of high impact grey polystyrene, those boxes are designed for slides. Each slot is numbered and can be cross-referenced with the corresponding index card supplied with each box.

Boxes are virtually unbreakable. Stackable.

**Dimensions** mm: 230 x 97 x 35 (50 slides), 230 x 180 x 35 (100 slides).

**It is recommended to use slides up to 2 mm thick.**



code	description	case quantity	case weight	case volume
19277	for 50 slides	1	0.24	0.002
19278	for 100 slides	1	0.40	0.003



### Slide boxes

Plain polyethylene slide box with clear polypropylene lid.

Not numbered.

Stackable.

**Dimensions** in mm: 105 x 88 x 32 (25 slides), 200 x 88 x 32 (50 slides)



code	description	case quantity	case weight	case volume
19276.1	for 25 slides	48	3.56	0.019
19277.1	for 50 slides	24	3.40	0.018



### Automatic slide dispenser

Made of ABS and PS, this dispenser can hold up to 50 standard slides. Slides are dispensed individually by rotating the knurled knob on either side of the moulded base.

**It is recommended to use slides up to 2 mm thick.**

code	description	case quantity	case weight	case volume
19540	for 50 slides 26 x 76 mm	1	0.20	0.002



### Slide storage system for 100 slides. Stackable

Made of high impact polystyrene. It can hold up to 200 standard slides.

Made of a box with a transparent lid with an easy opening and an internal removable rack.

This removable rack is divided into two parts with 50 numbered slots in each one, so 100 slides can be separately placed and their strips can be read. For space saving purposes, you can double the amount of slides simply by storing 2 slides per slot, so each part can hold up to 100 slides resulting in a total capacity of 200 slides. They can also be used without the internal rack, so the capacity reaches 400 slides.

Stackable. The internal rack allows discarding all the slides at the same time. The frontal part of the box can be written.

**External dimensions:** 82 x 245 x 86 mm.



code	colour	case quantity	case weight	case volume
19279.5	blue	10	3.30	0.023
19279.7	green	10	3.30	0.023

Other colors: consult with sales department minimum sale quantity and delivery time.

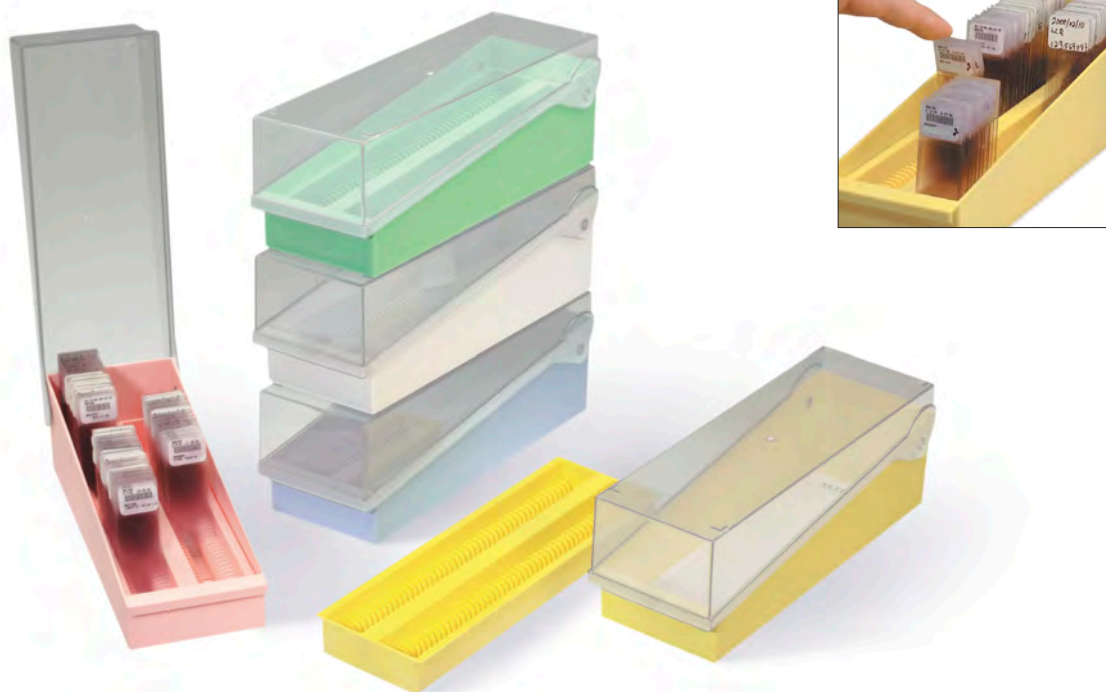

HISTOLOGY, MICROSCOPY AND STAINING

### Slide storage system for 50 slides. Stackable

Same characteristics as previous codes, it has half capacity. Each part of the inner rack can hold up to 25 separate slides with a total capacity of 50 slides, or for space saving purposes it has a total capacity of 100 slides by storing 2 slides in each slot.

**External dimensions:** 82 x 140 x 86 mm.



code	colour	case quantity	case weight	case volume
19274.5	blue	10	1.5	0.013

Minimum order quantity: 1 storage system.





# 05. CONTAINERS. SAMPLING



## 30 ml universal polystyrene containers

Polypropylene caps. 30 ml containers. These containers are manufactured with an innovative process resulting in one of the most resistant containers available on the market.

The standard cap colour is white.

*\*Other colours can be supplied (ask for quantities).*



mod.	code	description	sterile	case quantity	case weight	case volume	cases pallet
1	309202	polystyrene	no	400	5.20	0.045	32
2	309222	polystyrene individually wrapped	no	400	5.70	0.045	32
2	309222.0	polystyrene individually wrapped	STERILE EO	400	5.32	0.045	32

Withstand centrifugation up to: **7,000 xg**.

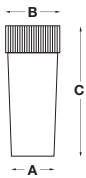

**Dimensions:**

A: 25.1 mm; B: 30.8 mm; C: 92.5 mm.

**Maximum volume:** 31,7 ml.

**Recommended volume:** 25 ml.



1



2

## 30 ml universal polypropylene containers

Made in Polypropylene. 30 ml containers. These containers are manufactured with an innovative process resulting in one of the most resistant containers available on the market. The screw closure can assure an almost leakproof closing system.

Polypropylene cap in white colour, except **409602** (blue). Other colours and labeled models can be supplied (ask for quantities).

**Autoclavable** (except the code **409602**, the polystyrene spatula must be removed before autoclaving).

*\*Other colours can be supplied (ask for quantities).*



mod.	code	description	sterile	case quantity	case weight	case volume	cases pallet
1	409202	polypropylene	no	400	4.50	0.040	32
2	409222	polypropylene individually wrapped	no	400	5.10	0.045	32
2	409222.0	polypropylene individually wrapped	STERILE EO	400	5.10	0.045	32
3	409602	polypropylene with PS spoon	no	400	4.70	0.044	32

Withstand centrifugation up to: **10,000 xg**.

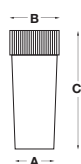

**Dimensions:**

A: 24.8 mm; B: 30.8 mm; C: 91.6 mm.

**Maximum volume:** 31,1 ml.

**Recommended volume:** 25 ml.



CONTAINERS. SAMPLING



### 30 ml container with boric acid

This container includes a boric acid preservative which allows the storage and transport of the urine sample to the laboratory. The boric acid supports the viability of the bacteria while preventing further multiplication. This preservative does not alter the characteristics of the urine and will not affect analysis. The bacteria remain viable for 24-48 hours or more, depending on the type of microorganisms. Boric acid quantity: 0.4 g. **Sterile by ethylene oxide.**

code	description	case quantity	case weight	case volume	cases pallet
409202.B	polypropylene with boric acid	400	5.70	0.045	32

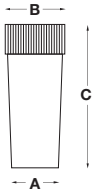

**Dimensions:**  
A: 24.8 mm; B: 30.8 mm; C: 91.6 mm.  
**Maximum volume:** 31,1 ml.  
**Recommended volume:** 20 ml.



### 40 ml containers

With polyethylene caps. Graduated.  
Volume 40 ml.

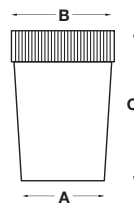

**Dimensions:**  
A: 29.1 mm; B: 35.7 mm.  
C: 69.8 mm.  
**Maximum volume:** 39 ml.  
**Recommended volume:** 30 ml.



code	description	case quantity	case weight	case volume	cases pallet
409402	container polypropylene	8 x 100	8.35	0.096	16
409426	container polypropylene, individually wrapped	800	10.50	0.110	16
309402	container polystyrene	8 x 100	11.00	0.096	16

## 50 ml containers

With polyethylene caps.  
Volume: 50 ml.



code	description	case quantity	case weight	case volume	cases pallet
409802	ultra clear polypropylene	700	9.30	0.096	16
409852	ultra clear polypropylene with PS spoon	700	9.30	0.096	16
409826	ultra clear polypropylene individually wrapped	600	8.40	0.096	16

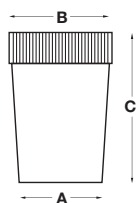

**Dimensions:**  
A: 35.1 mm; B: 41.5 mm; C: 72.3 mm.  
**Maximum volume:** 56 ml.  
**Recommended volume:** 45 ml.



CONTAINERS. SAMPLING

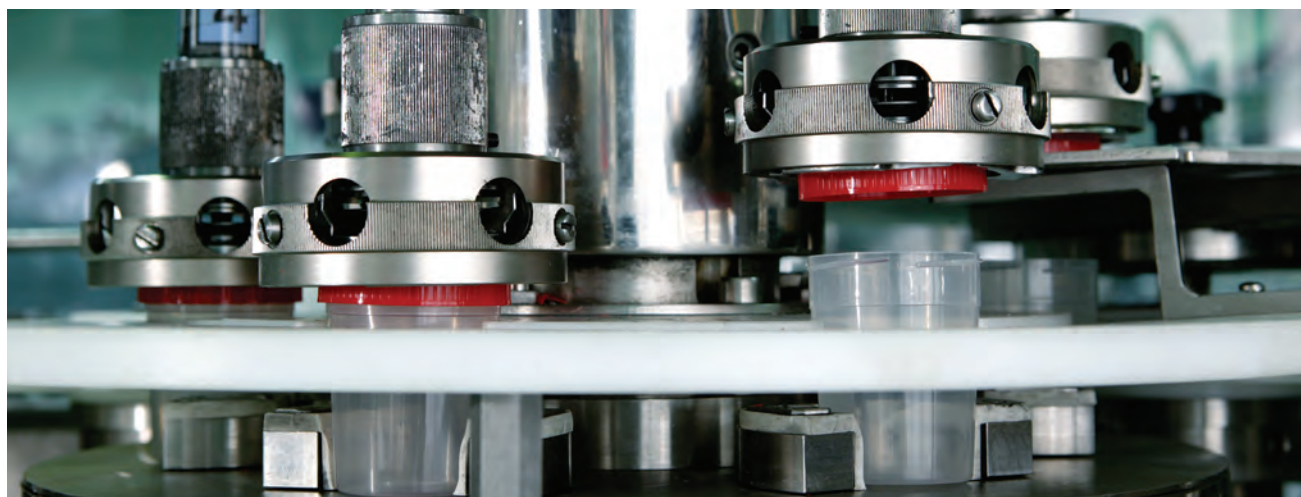



## 60 ml polystyrene containers

New generation of 60 ml containers with high safety closure biflex caps.  
Caps made of polyethylene.  
Standard colour of the cap: red.

\*Possibility of supplying the labeled bottles. (Check minimum quantities).



mod.	code	description	sterile	case quantity	case weight	case volume	cases pallet
1	309502	polystyrene	aseptic	600	9.10	0.096	20
2	309552	polystyrene with spoon	aseptic	600	9.10	0.096	16
3	309526	polystyrene individually wrapped	<b>STERILE A</b>	750	11.06	0.140	12

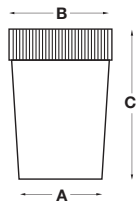

**Dimensions:**

A: 39.3 mm; B: 44.2 mm;  
C: 66.0 mm.

**Maximum volume:** 63 ml.

**Recommended volume:** 50 ml.

**STERILE A STERILIZATION TYPE:** in this case the parts are not sterilized at the end of its manufacture process since is the process by itself which is able to obtain a sterile product. This is because the entire process from injection of different plastic components to the assembly is protected by a sterile atmosphere, thanks to the cowl of the entire installation and the placement of laminar flows that create an overpressure sterile air inside the facilities.



CONTAINERS. SAMPLING



## Graduated 60 ml containers

Made of transparent polypropylene.  
Moulded graduation in 5 ml increments.  
Red polyethylene cap, biflex.  
For other cap colours ask the minimum order quantities.  
Supplied capped.

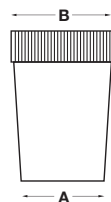

**Dimensions:**

A: 38.8 mm; B: 44.2 mm; C: 66.1 mm.

**Maximum volume:** 62 ml.

**Recommended volume:** 50 ml.



code	description	sterile	case quantity	case weight	case volume	cases pallet
409502G	polypropylene	aseptic	600	8.07	0.096	16
409502G.4	polypropylene, without lid	aseptic	600	8.10	0.096	16
409526G	polypropylene, individually wrapped	<b>STERILE A</b>	750	10.50	0.140	12

## 60 ml polypropylene containers

New generation of 60 ml sterile containers with high safety closure biflex caps.  
Specially designed for pneumatic transport of specimens.  
Caps made of polyethylene. Standard colour of the cap: red.

\*Possibility of supplying the labeled bottles. (Consult minimum quantities).



mod.	code	description	sterile	case quantity	case weight	case volume	cases pallet
1	409501	polypropylene labelled	aseptic	600	8.00	0.096	16
2	409502	polypropylene	aseptic	600	7.90	0.096	16
3	409552	polypropylene with spoon	aseptic	600	8.25	0.096	16
4	409526	polypropylene individually wrapped	STERILE A	750	10.15	0.140	12
-	409526.0	polypropylene individually wrapped	STERILE EO	750	10.30	0.140	12
5	409526.1	polypropylene individually wrapped, labelled	STERILE A	750	10.13	0.140	12

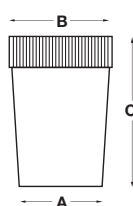
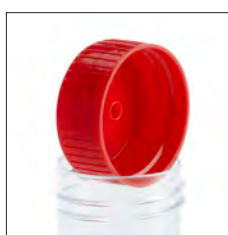

**Dimensions:**  
A: 38.8 mm; B: 44.2 mm; C: 66.1 mm.  
**Maximum volume:** 62 ml.  
**Recommended volume:** 50 ml.



CONTAINERS. SAMPLING

## Racks for containers up to 47 mm Ø

Stainless steel. 50 mm square holes.  
With a strong woven mesh base.



See metal racks in chapter  
**Sample Storage**



code	dimensions mm	distribution	quantity	weight	volume
I-240	315 x 210 x 45	24 (6 x 4)	1	0.35	0.0042
I-250	210 x 160 x 45	12 (4 x 3)	1	0.25	0.0022



## 120 ml containers with spoon

Ultra clear polypropylene containers with polyethylene leak proof screw caps. Spoon made of Polystyrene. Graduated in 20 ml increments. Frosted panel on side for easy writing. Standard colour of the cap: red.



mod.	code	description	sterile	case quantity	case weight	case volume	cases pallet
1	409752	polypropylene with PS spoon	no	450	8.14	0.140	16
2	409756	polypropylene individually wrapped with PS spoon	no	350	6.80	0.140	16
2	409756.B	polypropylene individually wrapped with PS spoon	STERILE R	350	6.50	0.140	16

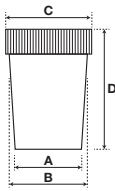

**Dimensions:**

A: 48.3 mm; B: 56.3 mm; C: 62.1 mm; D: 74.3 mm.

**Maximum volume:** 150 ml.

**Recommended volume:** 120 ml.



CONTAINERS. SAMPLING

## 120 ml containers uncapped

With the same characteristics as the previous model, but these containers are supplied uncapped.

Containers and caps are supplied in the same box.

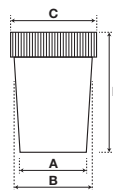

**Dimensions:**

A: 48.3 mm; B: 56.3 mm; C: 62.1 mm; D: 74.3 mm.

**Maximum volume:** 150 ml.

**Recommended volume:** 120 ml.



code	description	case quantity	case weight	case volume	cases pallet
409703	polypropylene uncapped	620	10.05	0.089	20

## 120 ml containers

Ultra clear polypropylene containers with polyethylene leak proof screw caps. Moulded graduation in 20 ml increments up to 100 ml. Frosted panel on side for easy writing. Standard colour of the cap: red.



mod.	code	description	sterile	case quantity	case weight	case volume	cases pallet
1	409701	polypropylene labelled	aseptic	450	7.95	0.140	16
2	409702	polypropylene	aseptic	450	7.72	0.140	16
3	409726	polypropylene individually wrapped	STERILE A	350	6.45	0.140	16
	409726.G	polypropylene individually wrapped	STERILE R	350	6.45	0.140	16

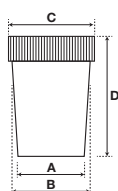
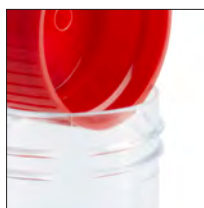

**Dimensions:**

A: 48.3 mm; B: 56.3 mm; C: 62.1 mm; D: 74.3 mm.

**Maximum volume:** 150 ml.

**Recommended volume:** 120 ml.



1



2

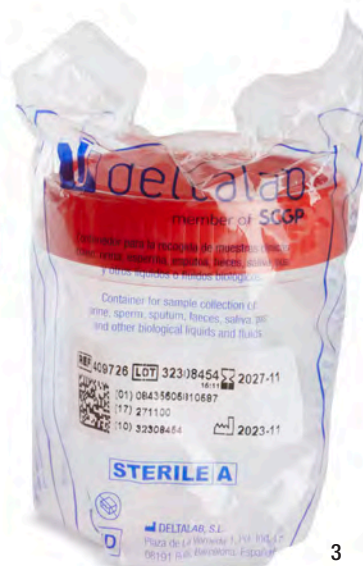

3

## 160 ml screw cap containers

Manufactured in polystyrene or polypropylene depending on the model.

Cap manufactured in polyethylene.

Code **309752** is supplied with a polystyrene spoon inside.

Code **409700** is **sterile by radiation**.

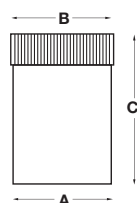

**Dimensions:**

1. A: 58 mm; B: 65,5 mm; C: 72,5 mm.

2. A: 57,5 mm; B: 64,5 mm; C: 70 mm.

**Maximum volume:** 160 ml.

**Recommended volume:** 120 ml.

mod.	code	description	sterile	case quantity	case weight	case volume
1	309752	polystyrene white cap and spoon	no	360	13.45	0.106
2	409700	polypropylene red cap	STERILE R	360	11.58	0.106



2



1



## Blue containers

With the same characteristics as codes **409702** and **409502** but in blue colour (containers and cap). Ideal for photosensitive samples or when it is required not to show the content.

Ask for other labeling or for not labeled containers to our sales department.

Minimum order quantity: 30,000 units.

Minimum order quantity: 1 pallet.



code	description	case quantity	case weight	case volume	cases pallet	quantity pallet
409511	60 ml container white label	600	8.20	0.096	16	9,600
409711	150 ml container white label	450	7.80	0.140	16	7,200

## 200 ml graduated container

Containers made of ultra clear polypropylene and caps made of polyethylene. Those containers have double moulded-in graduations, (in 20 ml increments up to 200 ml and in 1 oz increments up to 7 oz), and feature a frosted panel on their side for easy writing. Standard colour of caps: red.



### Dimensions:

A: 56.5 mm; B: 62.2 mm;

C: 115.5 mm.

**Maximum volume:**240 ml.

**Recommended volume:** 210 ml.



code	max. capacity	case quantity	case weight	case volume	cases pallet
409902	240 ml	275	7.20	0.140	16

## 200 ml screw cap container

Manufactured in polystyrene, cap made of white polyethylene.

Total volume: 220 ml.

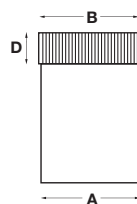

### Dimensions:

A: 58 mm; B: 62 mm;

C: 95 mm; D: 22 mm.

**Maximum volume:**240 ml.

**Recommended volume:** 210 ml.

code	max. capacity	case quantity	case weight	case volume	cases pallet
309903	220 ml	300	9.6	0.090	16

## Urine container set

Urine collection system designed to save space in the lab, and to be used when urine samples need to be collected into tubes for a subsequent centrifugation. Designed to be user friendly. The patient urinates in the 150 ml plastic cup and then pours the urine into the tube. Once the tube is filled up, the patient caps it and delivers the sample to the lab, where the health assistant will fill in the label with the required data. The patient just has to follow the hospital or laboratory instructions. **Manufactured under aseptic conditions.** Bag printed with batch number and expiry date. Easy pouring. We can manufacture sets with boric acid.

150 ml cup



150 ml container (body)



code	bag	container	tube	cap	capped	cap colour	label 25 x 35 mm	labelled	case quantity	case weight	case volume
309324.E3	✓	150 ml cup	400705	308102	✗	natural	✗	✗	300	4.15	0.140
309316	✓	150 ml cup	400705	308107	✗	green	✗	✗	300	4.10	0.140
319324.E13	✓	150 ml cup	2 x 400705 with boric acid	308102 / 308105	✓	natural/blue	✓	✓	300	5.96	0.140
309324	✓	150 ml cup	401204	308207	✗	green	✗	✗	300	4.70	0.140
309324.PS	✓	150 ml cup	301201	308202	✗	natural	✗	✗	300	4.70	0.140
319324.E10	✓	150 ml cup	300705	308102	✗	natural	✗	✗	4800	4.30	0.140
	✓				✗		✗	✗			

## Disposable cups

Disposable sample cups, for general sample collection. Cups are supplied stacked.

code	volume ml	material	mouth Ø x height	case quantity	case weight	case volume
202248	100	polypropylene	57.5 x 62	48 x 100	5.53	0.070
202317	150	polystyrene	70 x 70	30 x 100	8.32	0.080



## "Fast read" plate for urinary sediment cell count

Disposable plate for determining µl cells in the sample. Using this system a smaller number of epithelial cells present in each field can be achieved, reducing the possibility of overlapping with other cells. Ensures a more careful and precise result, providing technical staff to determine presence of cellular elements.



code	description	case quantity	case weight	case volume
141746	fast read plate for urinary sediment cell count	100	0.30	0.0008



CONTAINERS. SAMPLING

# 60 ml vacuum container with an innovative sterility seal

New urine sample collection bottle with vacuum system manufactured in Deltalab under sterile conditions (Sterile A).

## Advantages:

- Plastic packaging is eliminated due to the incorporation of the sterility seal on the bottle itself and this means a significant reduction in plastic waste of approx. 32%.
- This new bottle has a large mouth diameter of 56mm which offers great convenience to the user.
- A large amount of raw material is saved, resulting in a much more sustainable product.
- Thanks to its smaller size, it saves considerable space in transport and storage.
- The label is also a key element of this new product, containing all the necessary and regulatory information for its use and guaranteeing total traceability of the sample.
- Its innovative design with the needle overmoulded (and not threaded) avoids any kind of leakage.
- The low needle position minimises the residual dead volume that will remain in the bottle.
- Compatible with the vast majority of vacuum urine tubes on the market.



Environmentally friendly



## 60 ml vacuum container with an innovative sterility seal

Its 60ml volume allows optimisation of the collection space, adapting to health protocols and at the same time achieving clear functional, logistical and environmental advantages.

The vacuum system ensures safe transfer of urine from the bottle to the tube, eliminating the risk of leakage, splashing or cross-contamination in the collection tube.

This is a completely hygienic and safe system.  
It prevents sample loss and avoids the contamination of the sample, the user or the work environment.



code	description	steril	case quantity	case weight	case volume	cases pallet
409531	60ml flask with seal	STERILE A	650	9.27	0.14	12
409520	60ml flask with seal + vacuum 9ml tube	STERILE A + R	250	8.84	0.11	16

\* Consult with the sales department for individual bagged vacuum containers and customization options.

\* This new container is compatible with the 408900.K and 408910.K vacuum tubes and other tubes on the market.

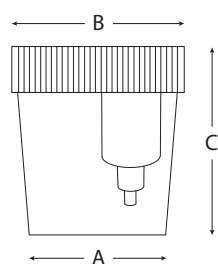

**Dimensions:**

A: 47.0 mm; B: 61.3 mm; C: 51.4 mm.

**Maximum volume (without lid):** 82 ml.

**Recommended volume:** 60 ml.



CONTAINERS. SAMPLING



## Containers and tubes for vacuum system

**120 ml containers** designed to use with vacuum tubes. It allows a clean transfer of the urine from the container to the vacuum tube.

Manufactured in transparent **Polypropylene**.

Leakproof cap made of yellow **polyethylene**, with an internal obturating ring. It includes a cannula with a needle inside protected by a rubber cap and a plastic suction nozzle.

The cap features a label that seals the cannula in order to prevent contact with the collection needle. The container features a wide marking area for sample identification and a graduation that helps to quantify the sample when uncapped. Once capped, the graduation is inaccurate as the volume is altered by the cannula.

**Maximum volume with cap:** 120 ml,

**Recommended volume:** 60 ml.

**Tubes in PET** produced with the inner cap in caoutchouc and outer cap in yellow polyethylene. Incorporating a label for sample identification, with white background and a transverse line in yellow to easily see that it is a tube for urine. Printed with the lot, expiration date, CE mark, volume of suction, manufacturer, and only one-use symbol.

**Label dimensions:** 36 x 20 mm.

Supplied in foam racks of 100 units, shrink-wrapped and labelled.

**This is a completely hygienic and safe system.  
It prevents sample loss and avoids the contamination of the sample, the user or the work environment.**



code	presentation	sterile	case quantity	case weight	case volume
<b>1. 120 ml container (dimensions: 57x73 mm)</b>					
408702	in bulk	no	450	8.93	0.140
408726	individually wrapped	no	350	7,50	0.140
408702.G	in bulk	STERILE R	400	8.16	0.140
408726.G	individually wrapped	STERILE R	350	7,50	0.140
<b>2. Vacuum tube (dimensions: 16x100 mm)</b>					
408900.K	vacuum tube, 9 ml	STERILE R	10 x 100	12.60	0.062
408910.K	vacuum tube, 9 ml with boric acid	STERILE R	10 x 100	13.70	0.044
<b>3. Kit container and vacuum tube</b>					
408720	KIT 408702.G + 408900.K	STERILE R	250	3.90	0.100
408721	KIT 408702.G + 408910.K	STERILE R	250	4.10	0.110

1



2



3



## Rectangular graduated until 3 litres container with handle

Product designed for collection of 24 hours urine samples.  
Container made of polyethylene and cap of polypropylene.

- Brown opaque body and cap depending on the model:
- **408600** Yellow cap with vacuum system
  - **408601** Yellow cap with vacuum system with long cannula
  - **408610** Standard white cap

The three of them are completely leakproof thanks to its sealing ring and ensure a total sealing of the sample.  
The vacuum system ensures a clean transfer of the urine from the container to the vacuum tube and prevents the risk of cross contamination in the handling of the sample. It also avoids sample loss by splashing or outpouring.  
The container has a handle with ergonomic empty space to facilitate a much more comfortable dump and the manual transport of the sample.  
It incorporates a translucent vertical stripe on one side where the graduation allows the control of the level of sample containing. Graduated each 100 ml, to 3,000 ml.

Total capacity: 3.3 l.  
Unit weight (without cap): 115 g ( $\pm$  3 g).  
Cap weight (vacuum system): 8.2 g ( $\pm$  0.2 g).  
Cap weight (standard system): 5.5 g ( $\pm$  0.2 g).



code	presentation	sterile	case quantity	case weight	case volume	cases pallet
<b>408600*</b>	3 l rectangular container for vacuum system	no	30	4.57	0.150	12
<b>408601*</b>	3 l rectangular container for vacuum system and long cannula	no	30	4.57	0.150	12
<b>408610</b>	standard 3 l rectangular container	no	30	4.52	0.150	12

\*Suitable for vacuum tubes **408900.K** and **408910.K**.



## Security screw cap containers

Ultra clear polypropylene containers with yellow polyethylene cap.  
They have moulded graduations in ml.

**Supplied uncapped** with the caps and containers in the same box.

Ideal for the pneumatic transport of liquid samples, including those that have phormaline, because they have a watertight closure. The cap, with an innovative inner shape, has a double closure. (see the figure). The base and the cap are ribbed so the handling with gloves is comfortable and reliable. There is a ring in the upper part of the body, in order to avoid the dripping in case of liquid decanting.

For other cap colours (blue, orange, magenta), ask for the minimum order quantities.



mod.	code	grad. volume ml	total volume ml	mouth Ø mm	height mm	case quantity	case weight	case volume
1	202840	20	26	34	43	1,000	8.84	0.090
2	202841	40	50	45	43	600	8.41	0.090
3	202842	60	76	45	60	500	8.00	0.110
4	202843	90	92	48	75	400	7.32	0.101
5	202848	90	108	53	68	300	6.35	0.102
6	202844	120	146	53	78	300	7.50	0.102

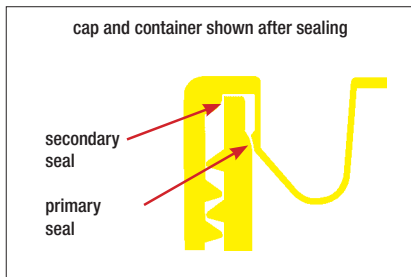

1

2

3

4

5

6

## Leak proof screw cap containers

Specially designed for histology, they are provided with double internal security closure. Manufactured in translucent polypropylene with polyethylene ribbed yellow cap. They have moulded graduations.

Their leakproof closure makes them ideal for liquid or solid sample storage. They meet the standard UNE-EN 14401.

**Supplied uncapped.**



See more information about this product in the **chapter Histology, microscopy and staining**



## Cylindrical container graduated up to 2 litres with handle

High density polyethylene container and cap. Ideal for 24 hour urine collection and any other liquid samples.

We recommend references with white and ribbed cap, that features a pharmaceutical grade liner, **which eliminates the need for an insert plug**, allows a better handling and provides a watertight seal.

Containers are graduated in 50 ml increments up to 2 l. Include a convenient handle for an easy single-handed use.

Base diameter: 108 mm.

Height, cap included: 290 mm.

Cases per pallet: 16.

Codes **408001.1** and **408001.0** are individually wrapped by retractile system.

Ask for other versions cap colours, capped containers and sterile containers.



code	body colour	cap description	presentation	individually wrapped	sterile	internal mouth Ø mm	case quantity	case weight	case volume
408001	natural	white, with liner	unscrewed	no	no	66,5	34	4.50	0.140
408001.0	natural	white, with liner	screwed	yes	STERILE R	66,5	34	4.50	0.140
408001.1	natural	white, with liner	screwed	yes	no	66,5	34	4.38	0.140
4080010BT	natural	black + plug	unscrewed	no	no	66.5	33	4.20	0.140
4080010/T	natural	black + plug	screwed	no	no	66.5	33	4.59	0.140
 720.1	natural	black + plug	screwed	no	no	80	40	4.67	0.140



## Rectangular containers, graduated up to 2 litres

2-litre rectangular bottles made of high-density **polyethylene**. Natural translucent or opaque brown body graduated in relief every 50 ml up to 2,000 ml. Includes a side slit for easy handling. Screw cap made of high-density polyethylene.

**Internal diameter of the mouth:** 66.5 ± 1 mm. **Weight without cap:** 95 ± 3 g.

**Height without cap:** 251 ± 1.5 mm.

**Length:** 125.5 ± 1.5 mm. **Width:** 85 ± 1 mm.

**Overflow capacity:** 2,360 ± 50 ml.

The bottles are supplied with caps in a separate bag.

Code 407001/T is supplied capped. Codes 407008, 407008.0 and 4070080BT are supplied capped and shrink-wrapped.

Various versions of the cap according to the reference (see table below).

The white cap has an internal seal that acts as a shutter and guarantees total tightness and is ribbed for a better grip.



code	body colour	cap description	presentation	individually wrapped	sterile	case quantity	case weight	case volume
407001	natural	A- white, with liner*	unscrewed	no	no	43	6.00	0.140
407001/T	natural	A- white, with liner*	screwed	no	no	43	6.00	0.140
407008	natural	A- white, with liner*	screwed	yes	no	43	6.40	0.140
407008.0	natural	A- white, with liner*	screwed	yes	STERILE R	43	6.40	0.140
4070010BT	natural	B- black + plug PE	unscrewed	no	no	41	5.90	0.140
4070080BT	natural	B- black + plug PE	screwed	yes	no	41	5.90	0.140
407003	brown	A- white, with liner*	unscrewed	no	no	43	6.00	0.140

\* Internal joint that acts as a shutter and guarantees a tightness



## Squared containers, graduated up to 2.7 l

High density polyethylene container and cap. Ideal for 24 hour urine collection and other liquid samples. The ribbed cap features a plexan liner, which **eliminates the need for an insert plug**, allows a better handling and provides a watertight seal. Containers are graduated in 50 ml increments up to 2.7 l. Ergonomically designed for single-handed use. A ring on the neck of the containers avoids dripping when pouring.

Length x width: 131 x 124 mm ( $\pm 1$  mm).  
 Height, cap excluded: 244 mm ( $\pm 1.5$  mm).  
 Individually wrapped models are supplied capped.  
 Cases per pallet: 12.



code	body colour	presentation	individually wrapped	sterile	mouth Ø mm	case quantity	case weight	case volume
407005	natural	unscrewed	no	no	66	34	5.52	0.150
407005/T	natural	screwed	no	no	66	34	5.52	0.150
407005.0	natural	screwed	yes	STERILE R	66	34	5.70	0.152
407006	brown	unscrewed	no	no	66	34	5.70	0.154
407006/T	brown	screwed	no	no	66	34	5.50	0.150



## 50 ml hinged lid container

Specially designed for **milk, wine and agroalimentary oil**, although it is also suitable for other liquid or solid samples.

Recommended for its use with **FOSS® and DELTA® analytical systems**, among others.

Made of **autoclavable** polypropylene. Tamper evident Lid, attached to the body by means of a hinge.

The lid is conceived to maintain 90° after its opening, enabling this pot to be used with just one hand. It has a frosted squared surface for identification. Excellent mechanical and chemical resistance.



code	description	case quantity	case weight	case volume	cases pallet
420046	container	800	7.5	0.140	12
420056	container with individually wrapped	800	7.5	0.140	12

\* Consult the sales department for bottles in different colors.

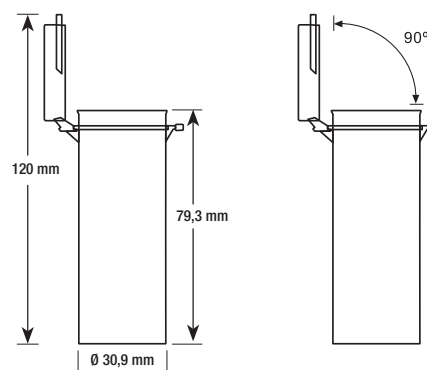

CONTAINERS. SAMPLING



## Security screw cap containers

Natural colour high density polyethylene containers. Capacities: 30, 60 and 125 ml. Ideal for liquids. 60 and 125 ml containers: Bottles with screw cap, leakproof closure with child-proof system and split seal. The cap is compound by two pieces that turn around themselves avoiding the cap to be opened, working as a security closure avoiding the accidental manipulation. To open the cap push it down following the figure on the cap. The sealed caps need to be unscrewed to break the seal, showing that it has not been manipulated. 30 ml container **444603202** has a security seal, not the child-proof system closure. Pallet cases quantity: 16.

code	cap colour	body colour	height mm	Ø base mm	body weight g	case quantity	case weight	case volume
<b>1. Capacity: 30 ml. Ø Pilfer mouth 25, security closure tamper evident</b>								
444603202	white	natural	69.0	31.0	6.2	1.100	11.32	0.103
<b>2. Capacity: 30 ml. Ø Pilfer mouth 28, security closure childproof system</b>								
444603204	white	white	60.5	35.6	7.0	600	10.00	0.078
<b>3. Capacity: 60 ml. Ø Pilfer mouth 28, security closure childproof system</b>								
444603300	white	natural	93.7	37.6	9.5	600	11.80	0.113
444602903	white	white	93.7	37.6	9.5	600	8.00	0.110
<b>4. Capacity: 125 ml. Ø Pilfer mouth 28, security closure childproof system</b>								
444603402	white	natural	114.8	48.0	13.6	300	5.15	0.110

We can supply other colours if required.



1



2



3



3



4

## 25 ml cups

Clear polypropylene cup with cover in natural polyethylene, graduated up to 25 ml. Dimensions: Ø mouth: 35 mm, Ø base: 27 mm, height 40 mm. The cups are supplied bagged in stacks of 100 units.



See chapter  
Sample storage



code	description	case quantity	case weight	case volume
430130	standard graduated cup	60 x 100	9.29	0.061
430130.1	reinforced graduated cup	60 x 100	13.00	0.065
430100.1	push cover	3 x 2,000	5.80	0.060
 430100100*	single dose cap	60 x 100	7.20	0.072

\* Consult minimum order.





## Whirl-Pak® bags

Made of a **low density polyethylene** blend, resulting in a **very resistant** and **transparent bag**. Suitable for both solid and liquid samples. The plastic thickness depends on the model (57 to 102 µ). **Hermetic closure** by rounded and flat metal rods (code 200356). Whirl-Pak® bags stand out for their unique feature: the seam of each bag is **made in one piece, which eliminates the risk of loss by the corners of the bag**. All bags (except code 200372) are **sterile by ethylene oxide**. All bags (except code 200372) are **made with materials suitable for food use**. All bags have rounded rods except code 200356 which has flat rods. There are some codes with white bands to write.

### Instructions for use of Whirl-Pak® bags



1. Tear off top of bag along perforation.

2. Use pull tabs to open bag.

3. Place sample in bag.

4a. Hold bag by wire ends and whirl three times to close.

4b. Or, fold the tab over tightly three times to close (used to close larger bags).

5. Bend wire ends onto bag.



### Whirl-Pak® bags with flat wires

Same features as those from the following page but with a flat thicker wire instead of rounded wire resulting in a safer closure.

**With white write-on strip.**  
**Made with materials suitable for alimentary use.**  
**Sterile by ethylene oxide.**

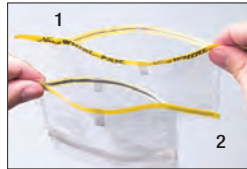

1. Rounded wire  
2. Flat thicker wire



code	capacity ml	dimensions cm	thickness microns	case quantity	case weight	case volume
200356	540	11.5 x 23	64	500	2.18	0.0074

### Whirl-Pak® stand-up bags

Same characteristics as Whirl-Pak® standard bags. However, they have a flat bottom which permits them to remain stand up when the sample is inside the bag. This allows to have both hands free when working so you can add or to extract the content comfortably. No need of any rack. Working as a beaker or bottle, when they are empty they take up much less space.

**They have a write-on white strip.**  
**Made with materials suitable for alimentary use.**  
**Sterile by ethylene oxide.**



code	capacity ml	dimensions cm	thickness microns	case quantity	case weight	case volume
200361	540	11.5 x 23	64	500	2.50	0.017
200365	2,070	19 x 38	102	250	4.52	0.019



## Sterile Whirl-Pak® sampling bags

Suitable for both solid and liquid samples.

**Leakproof** closure by several metallic rounded sticks when you turn closure bands three times (see picture).

No autoclavable. Do not use temperatures over to 82 °C.

**Sterile by ethylene oxide.**

**Made with materials suitable for alimentary use.**

**Suitable for liquid nitrogen.**

**Without strips**



code	capacity ml	dimensions cm	thickness microns	case quantity	case weight	case volume
200325	60	7.5 x 12.5	57	500	0.84	0.005
200340	120	7.5 x 18.5	57	500	1.06	0.005
200341	210	9.5 x 18	76	500	1.50	0.005
200342	390	13 x 19	76	500	2.50	0.017
200329	540	11.5 x 23	64	500	2.04	0.007
200332	720	15 x 23	76	500	2.94	0.017
200343	720	15 x 23	102	500	3.88	0.017
200345	1,080	12.5 x 38	76	500	3.90	0.017
200346	1,260	15 x 38	76	500	3.92	0.017
200347	2,070	19 x 38	76	500	5.76	0.017

**With white band for identification:**

code	capacity ml	dimensions cm	thickness microns	case quantity	case weight	case volume
200326	60	7.5 x 12.5	57	500	0.78	0.005
200349	120	7.5 x 18.5	57	500	1.02	0.005
200364	390	13 x 19	64	500	2.02	0.017
200330	540	11.5 x 23	64	500	1.97	0.008
200333	720	15 x 23	76	500	3.06	0.017
200351	1,650	19 x 30	102	500	5.66	0.018
200363	2,070	19 x 38	76	500	5.54	0.019
200357	2,700	25.4 x 38	102	250	5.32	0.022
200358	3,600	25.4 x 50.8	102	250	6.46	0.022
200359	5,400	38 x 50.8	102	100	5.26	0.023



\*The bags capacity is that achieved with the closing performed following the instructions described above and the volumes are only approximated.



### Specimen transport kangaroo bags

For tube transport. Double pouch design: one for specimen tubes and the other for documents. Includes a safety seal.

Reclosable (zip-lock design). Dimensions: 16x16.5 cm.

Made of polyethylene.

code	colour	thickness µm	case quantity	cases weight	case volume
V 160230	green	50	2 x 1,000	10.89	0.029
N 160230	orange	50	2 x 1,000	11.25	0.025

### Zip-lock bags

Made of transparent polyethylene, very resistant to shocks and tearing.

For all solid samples.

Made with materials suitable for food use.



code	gauge	dimensions* mm	case quantity	case weight	case volume
M 5555	200	55 x 55	2,000	0.94	0.0028
M 6080	200	60 x 80	2,000	1.23	0.0044
M 70100	200	70 x 100	2,000	2.20	0.0040
M 80120	200	80 x 120	2,000	2.18	0.0060
M 80160	200	80 x 160	2,000	3.33	0.0073
M 100150	200	100 x 150	2,000	3.20	0.0079
M 110110	200	110 x 110	2,000	3.10	0.0080
M 120180	200	120 x 180	2,000	4.61	0.0102
M 150220	200	150 x 220	2,000	8.00	0.0185
M 180250	200	180 x 250	2,000	0.43	0.0010
M 200300	200	200 x 300	2,000	11.52	0.0261
M 250330	200	250 x 330	2,000	15.70	0.0350
M 300400	200	300 x 400	1,000	13.06	0.0230

\*Real dimensions are stated for the bags.

### White strip zip-lock bags

Same features as the above products.

Made with materials suitable for food use.

Feature white strip for writing for better sample identification.



code	gauge	dimensions* mm	case quantity	case weight	case volume
M 5555B	200	55 x 55	2,000	0.79	0.0022
M 6080B	200	60 x 80	1,000	0.61	0.0022
M 80120B	200	80 x 120	1,000	1.48	0.0035
M 70110B	200	70 x 110	1,000	0.98	0.0037
M 100150B	200	100 x 150	1,000	1.72	0.0045
M 120180B	200	120 x 180	1,000	2.24	0.0058
M 160220B	200	160 x 220	1,000	3.64	0.0085
M 180250B	200	180 x 250	1,000	4.77	0.0135
M 200300B	200	200 x 300	1,000	5.91	0.0148

\*Real dimensions are stated for the bags

## Syringes

3-piece syringes made of body, plunger and sealing gasket. Transparent PP cylindrical body, with support fins and provided with a ring Safety that prevents accidental exit of the piston.

With an indelible graduated scale according to the International System of Measurements.

In unitary container, sterilized by ethylene oxide.

Non-pyrogenic and latex free product, PVC and Phthalates.

For version with needle, contact the sales department.



code	volume	description	case quantity	case weight	case volume
JS1	1ml	3C centered luer	32 x 100	13	0.113
JS2	2ml	3C centered luer	30 x 100	13	0.113
JS3	5ml	3C centered luer	24 x 100	15	0.113
JS4	10ml	3C eccentric luer	16 x 100	15.5	0.113
JS5	20ml	3C eccentric luer	16 x 50	14	0.100
JS6	60ml	3C eccentric luer	16 x 25	16	0.120
JS8	60ml	3C catheter	16 x 25	17	0.120
JS9	100ml	3C catheter luer adapter	4 x 25	6.5	0.060



CONTAINERS. SAMPLING



## Isothermal bags

Isothermal bags for the transport of biological samples, manufactured from PEVA, PE and polyurethane (foam). The isothermal bags have two functions: keeping the temperature of samples for 6 hours while being transported, whatever the climatic conditions; protecting the samples and their contents. Available in green.

**Description:** for added security, isothermal bags feature three different locks: by velcro (excepting 6 l model), by zip fastener and by a coded padlock. Bags include the following elements:

- An inner pocket designed to hold the cold packs,
- A transparent outer pocket, at the front of the bag, for laboratory identification,
- A transparent pocket, over the top of the bag, to insert documents.
- Two cold packs (except **900073** which incorporates only 1) consisting of HDPE packs filled with a non toxic gel.

Before use, place cold packs in the freezer and keep at  $-20\text{ }^{\circ}\text{C}/-24\text{ }^{\circ}\text{C}$  for 24 hours.

### Quality features:

- Bags manufactured from sturdy and shockproof materials.
- Stand out from other isothermal bags existing on the market for their lightness and convenience.
- Offer a total security seal thanks to padlock.
- Space-saving and supplied folded in to reduce volume by 50 %.
- To clean, simply use standard detergents.
- Corners are rounded and reinforced by a double seam. Handles are sewn all around the bag for increased strength.
- Isothermal bags are traditionally manufactured (non-automated production), and each product undergoes rigid quality controls.

code	internal dimensions mm	external dimensions mm	capacity	case quantity	case weight	case volume
<b>900073</b>	230x230x170	200x200x150	6	1	0.63	0.004
<b>900074</b>	220x220x260	200x200x240	10	1	1.17	0.010
<b>900076</b>	390x250x280	370x230x260	27	1	1.38	0.011
<b>900078</b>	450x300x300	430x280x280	40	1	1.51	0.014



## Bottles for water sampling

Sterile bottles, designed according to ISO standards for sampling of consumption water.

Available with thiosulfate (microbiological analysis) and without thiosulfate (physico-chemical analysis).

Bottles are available in polyethylene or PET.

Capacities vary from 500 to 1,000 ml.

Different options available:

- Personalized labels,
- Individually bagged bottles,
- Special dosifications of thiosulfate,
- Other bottles or jars from the catalogue, etc.



See more information in chapter **Microbiology**

## Cytology brush

Blue ABS shaft. For cervical specimen collection, designed for taking cell samples without damaging them.

Includes a soft tip to provide more comfort for patients.

Sterile model is sterilized by ethylene oxide and includes instructions.

**Total length:** 19.5 cm.



code	description	case quantity	case weight	case volume
440150	non sterile	50 x 50	3.55	0.009
440151	<b>STERILE EO</b> individual peel-pack	2 x 500	3.23	0.029



## Vaginal speculum

Made from ultra-transparent material that allows excellent total visibility during gynecological examination. Being single-use, they eliminate the risk of cross-contamination and infections. This way, cleaning, packaging and re-sterilization, which is required with traditional reusable specula, is avoided. Highly resistant, they offer maximum safety due to their design and manufacture.

Packaged in medical paper + plastic.



code	colour	dimensions mm	case quantity	case weight	case volume
150611	white	65 x 20	50	2.00	0.025
150613	red	90 x 26	50	2.40	0.025
150614	green	95 x 30	50	2.10	0.038



## AYRE wood spatula

Rounded edges.

Sterile model is sterilized by **ethylene oxide** and includes instructions.

**Total length:** 178 ± 5 mm.



code	description	case quantity	case weight	case volume
440142.0	non sterile	50 x 100	10.00	0.025
444150	<b>STERILE EO</b> individual peel-pack	2 x 500	5.10	0.029



## AYRE plastic spatula

Made of **autoclavable** polypropylene.

Rounded edges.

Sterile model is sterilized by **ethylene oxide** and include instructions.

**Total length:** 179 ± 1 mm.



code	description	case quantity	case weight	case volume
440142	non sterile	5 x 500	7.00	0.025
444142	<b>STERILE EO</b> individual peel-pack	2 x 500	4.60	0.029
444242	<b>STERILE EO</b> individual flow-pack	2 x 500	4.60	0.029



Minimum ordering quantity: 500.





# 06. TUBES, MICROTUBES AND CRYOVIALS





## Round bottom polystyrene tubes

Manufactured from high technology, new generation moulds to ensure the reproducibility of each tube.  
Tubes are made in one piece to ensure uniformity and dimensional accuracy from tube to tube.



mod.	code	dimensions mm	volume ml	case quantity	case weight	case volume	cases per pallet
1	300500	11 x 55	3	2 x 2,000	6.50	0.046	32
2	300300	11 x 70	4	3 x 1,000	6.20	0.045	32
3	300800	12 x 75	5	4 x 1,000	9.52	0.075	20
4	300800.2	12 x 75 thick wall	5	4 x 1,000	10.70	0.075	20
5	300800.1	12 x 75	5	4 x 1,000	9.75	0.072	20
6	300400	12 x 88	6	4 x 1,000	11.30	0.082	20

Codes 300800 and 300400 are graduated (in-mould).

Suitable for centrifugation up to **7,500 xg**.  
All tubes are suitable for laboratory use.  
A complete range of test tube caps is detailed on page 155 of this catalogue.

### Dimensions (±0.09)

code	internal diameter mm	external diameter mm	total length mm	maximum volume ml
300500	10	11.5	54.4	3.5
300300	9.1	10.8	69.4	4.0
300800	10.3	11.8	74.5	5.5
300800.1	10.2	11.8	74.5	5.5
300800.2	10	11.8	74.5	5.3
300400	10.4	12	87.6	5.9

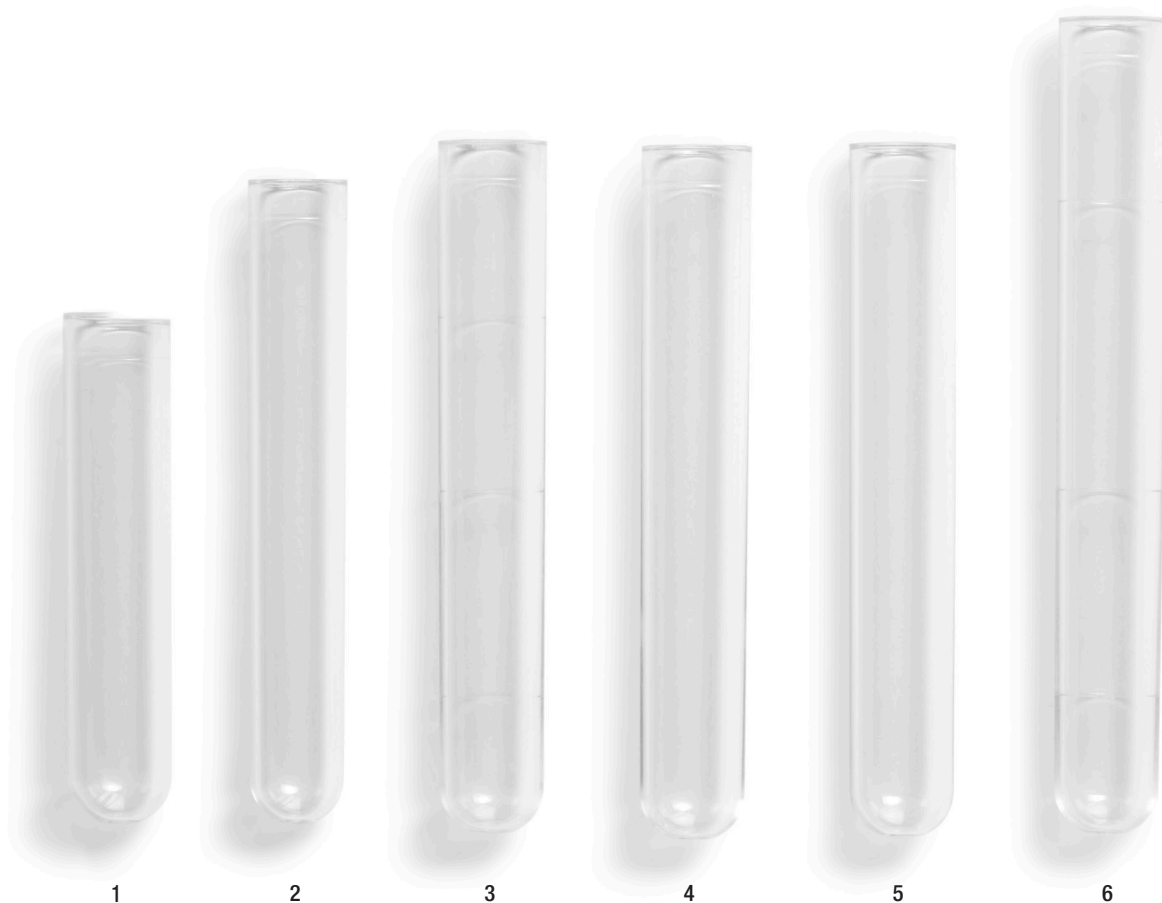

## Round bottom polystyrene tubes

Manufactured from high technology, new generation moulds to ensure the reproducibility of each tube. Tubes are made in one piece to ensure uniformity and dimensional accuracy from tube to tube.



mod.	code	dimensions mm	volume ml	case quantity	case weight	case volume	cases per pallet
1	300700	13 x 75	5	4 x 1,000	13.04	0.082	20
2	301700	13 x 100	7	6 x 500	11.24	0.084	20
3	300900*	16 x 95	10	5 x 500	12.10	0.096	16
4	300705	16 x 100	10	5 x 500	15.00	0.110	16
5	300100	16 x 150	17	1,000	9.84	0.093	20

\*Code 300900 with graduation rings.

Suitable for centrifugation up to **7,500 xg**.  
\*Suitable for centrifugation up to **4,000 xg**.

All tubes are suitable for laboratory use (except code **300100**, which does not withstand centrifugation).

A complete range of test tube caps is detailed on page 155 of this catalogue.

### Dimensions ( $\pm 0.09$ )

code	internal diameter mm	external diameter mm	total length mm	maximum volume ml
300700	10.9	12.9	74.7	6.7
301700	11.0	12.9	99.6	8.3
300900*	13.8	15.8	94.6	12.2
300705	13.8	16.0	99.8	13.2
300100	14.6	16.3	151.0	21.1



1



2



3



4



5

## Ultra clear polypropylene round bottom tubes

Manufactured from high technology, new generation moulds to ensure the reproducibility of each tube.

Tubes are made in one piece to ensure uniformity and dimensional accuracy from tube to tube.

Autoclavable up to 121 °C.



mod.	code	dimensions mm	volume ml	case quantity	case weight	case volume	cases per pallet
1	400500	11 x 55	3	2 x 2,000	6.50	0.045	32
2	400800	12 x 75	5	4 x 1,000	8.00	0.075	20
3	400800.1	12 x 75	5	4 x 1,000	8.00	0.075	20
4	400700	13 x 75	5	4 x 1,000	11.15	0.082	20
5	400400	12 x 88	6	4 x 1,000	9.60	0.082	20
6	401700	13 x 100	7	6 x 500	9.40	0.082	20
7	400900*	16 x 95	10	5 x 500	10.10	0.096	16
8	400705	16 x 100	10	5 x 500	12.20	0.096	16
9	401100	15 x 50	5	5 x 1,000	10.40	0.082	20

\*Codes 400800, 400400, 400900 y 401100 with graduation rings.

Suitable for centrifugation up to **7,500 xg**.

\*Suitable for centrifugation up to **4,000 xg**.

All tubes are suitable for laboratory use.

A complete range of test tube caps is detailed on page 155 of this catalogue.

### Dimensions (±0.09)

code	internal diameter mm	external diameter mm	total length mm	maximum volume ml
400500	9.9	11.4	53.9	3.4
400800	10.3	11.7	73.9	5.3
400800.1	10.2	11.7	73.9	5.3
400700	10.9	12.7	73.7	6.4
400400	10.3	11.9	86.9	5.8
401700	11.0	12.7	98.4	8.1
400900	13.7	15.5	93.7	11.9
400705	13.7	15.8	98.6	12.7
401100	13.7	15.5	48.9	6.5

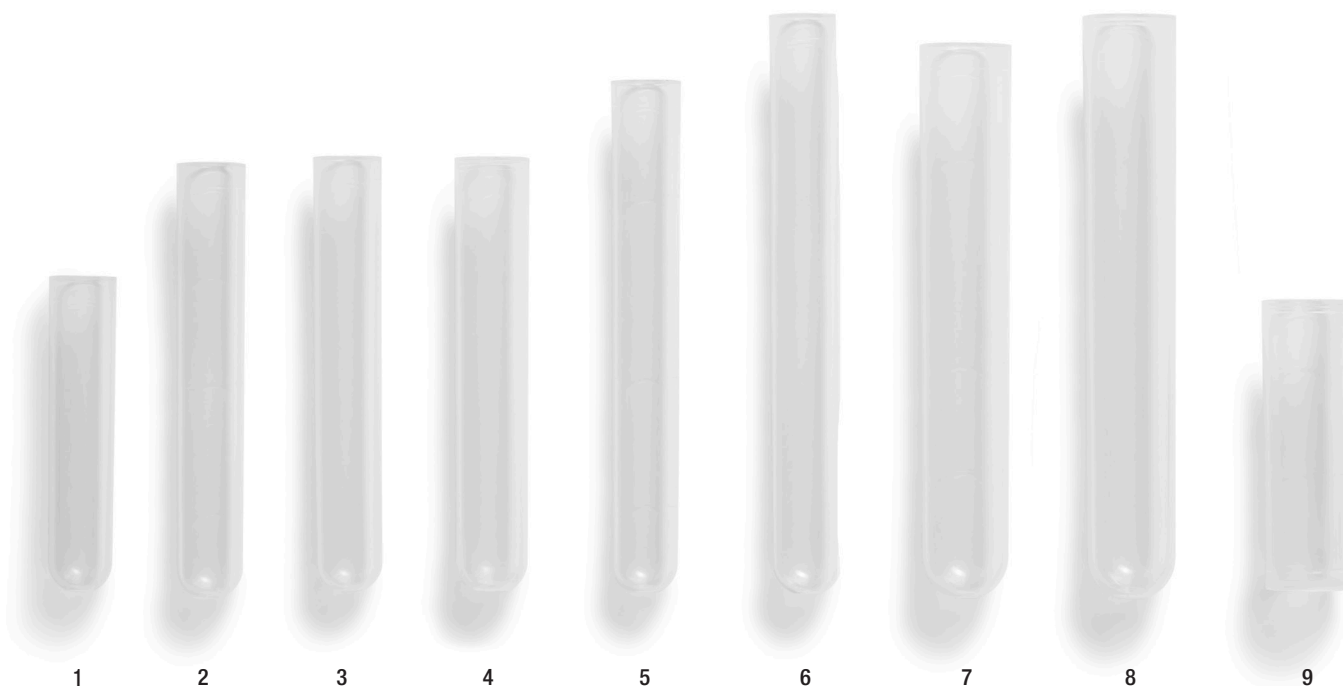

## Polystyrene round bottom tubes capped

Volume:

code **300702**: 5 ml.

code **300903**: 10 ml.

code **300907**: 11 ml.

Suitable for centrifugation up to **7,500 xg**.



mod.	code	dimensions tube mm	height tube + cap mm	case quantity	case weight	case volume	cases pallet
1	<b>300702</b>	13 x 75	83.4	2 x 1,000	7.92	0.045	32
2	<b>300903</b>	16 x 95	105.2	4 x 500	13.00	0.110	48
3	<b>300907</b>	16 x 100	109.6	4 x 500	15.41	0.110	12

Components :

mod.	code	tube	cap
1	<b>300702</b>	<b>300700</b>	<b>307107</b>
2	<b>300903</b>	<b>300900</b>	<b>308107</b>
3	<b>300907</b>	<b>300705</b>	<b>308107</b>



## Polystyrene round bottom tubes, capped and labelled

Volume:

code **300704**: 5 ml.

code **300904**: 10 ml.

code **300908**: 11 ml.

Dimensions of the label: 35 x 25 mm.

Suitable for centrifugation up to **7,500 xg**.



mod.	code	dimensions tube mm	height tube + cap mm	case quantity	case weight	case volume	cases pallet
1	<b>300704</b>	13 x 75	83.4	2 x 1,000	7.50	0.046	40
2	<b>300904</b>	16 x 95	105.0	4 x 500	13.00	0.110	48
3	<b>300908</b>	16 x 100	110.4	4 x 500	14.00	0.110	16

Components :

mod.	code	tube	cap	label
1	<b>300704</b>	<b>300700</b>	<b>307107</b>	✓
2	<b>300904</b>	<b>300900</b>	<b>308107</b>	✓
3	<b>300908</b>	<b>300705</b>	<b>308107</b>	✓



See chapter  
Containers. Sampling

## Conical tubes

Manufactured in polypropylene (PP) and polystyrene (PS).



mod.	code	autoclavable	dimensions mm	material	volume ml	case quantity	case weight	case volume	cases per pallet
1	301200*		16 x 102	PS	12	5 x 500	12.92	0.096	16
2	401200*	✓	16 x 102	PP	12	5 x 500	10.60	0.096	16
3	301213		17 x 105	PS	12	1,500	8.80	0.088	20
4	301212		17 x 105	PS	12	1,500	8.80	0.088	20
5	301201		16 x 100	PS	12	5 x 500	12.63	0.096	16
6	401201	✓	16 x 100	PP	12	5 x 500	10.75	0.096	16
7	301202		16 x 102	PS	12	5 x 500	12.90	0.096	16
8	401204*	✓	16 x 100	PP	12	5 x 500	10.20	0.096	16

\* Codes with internal graduations.

Codes **301213** (mod. 3) and **301212** (mod. 4) are flared at their top for easy pouring and have a special sedimentation base.

Codes **301200** (mod. 1), **401200** (mod. 2) and **301202** (mod. 7) have an external rim.

All models are suitable for centrifugation.  
PS tubes: **7,500 xg**; PP tubes: **15,000 xg**.  
Except code **301212** and **301213** to **3,000 xg**.

### Dimensions (±0.09)

code	internal diameter mm	external diameter mm	total length mm	maximum volume ml
• 301200	14.5	19.1/16.4	100.8	12.9
• 401200	14.4	18.8/16.2	99.8	12.5
• 301213	15.4/19.2	17.1/19.2	105.1	16.5
• 301212	15.4/19.2	17.1/22.0	105.0	16.4
301201	14.5	16.4	99.5	12.9
401201	14.4	16.2	98.4	12.5
• 301202	14.5	19.1/16.4	100.8	12.9
401204	14.4	16.2	98.4	12.5

• External diameter of the rim.



1

2

3

4

5

6

7

8

## Caps polyethylene

mod.	code	to fit tubes	yellow	natural	malve	blue	green	red	black	bag quantity	bag weight	bag volume
			(to add at the end of the code)									
1	3053	300500, 400500, 300800.2		02	08		07	06		2.000	0.80	0.005
2	3058	300800, 400800, 300800.1, 300400, 400400, 400800.1		02		05	07	06	09	2.000	1.76	0.007
3	3070	300100						07		1.000	1,20	0,009
4	3071	300700, 301700, 400700, 401700, 300701, serie 300700.6	01	02	08	05	07	06	09	2.000	1.52	0.007
5	3072	300705, 300900, 400705, 400900, 401100, 300707		02		05	07	06		2.500	3.00	0.018
6	3050	300705, 300900, 400705, 400900, 401100, 300907, 300904, 300908		02	08		07			2.500	3.26	0.019
7	3081	300705, 300900, 400705, 400900, 401100, 300707, 300907, 300904, 300908		02			07	06		2.500	5.00	0.023
8	3055	301201, 401201, 301200, 401200, 301202, 401204		02			07			2.500	4.00	0.018
9	3082	301201, 401201, 401204		02		05				2.500	5.10	0.023
10	3066	301213, 301212	01							1.500	1.28	0.012

Ask for other colours.



mod.	code	recommended tubes	colour	bag quantity	bag weight	bag volume
11	705722	300705, 300900, 400705, 400900, 401100	red	1,000	1.13	0.005
12	701061	300800, 300801	green	1,000	0.60	0.004
13	701034	300300	natural	1,000	0.62	0.003
14	705595	300500, 300800.2	red	1,000	0.70	0.003

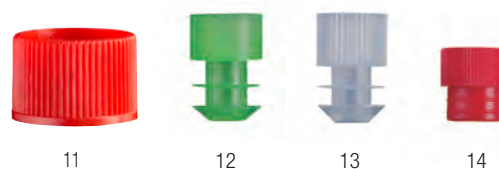

Ask to the sales department for other colors..

## Re-caps

Ideal for re-capping blood collection tubes «vacuum type». Suitable for other glass and plastic tubes. Manufactured in flexible polyethylene. Easy to cap and remove.



Please find racks for these tubes on chapter **Sample Storage**

code	description	bag quantity	bag weight	bag volume
308502	Ø 12-13 mm natural colour	6 x 1,000	1.70	0.025
308506	Ø 12-13 mm red colour	6 x 1,000	3.31	0.025
308602	Ø 15,2-16 mm natural colour	6 x 1,000	1.70	0.025

Other colours available on request, minimum order quantity is 6,000 units.





### General features of our caps

Includes an internal chamber for more liquid filling, thus compensating for the loss of space inside the tube caused by the insertion of a cap.



code	internal diameter mm	external diameter mm	total length mm
3050	13.95	19.30	13.15



Includes a small internal chamber. Light-weighted. Ergonomical. Ribbed for a better handling while using gloves.



code	internal diameter mm	external diameter mm	total length mm
3053	10.00	11.85	11.30



Those three flange plug caps present significant advantages over other flange caps existing on the market.

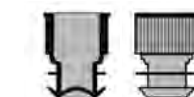

code	internal diameter mm	external diameter mm	total length mm
3055	14.50	17.05	21.77
3072	15.40	17.00	21.60
3071	11.25	13.30	17.40



Light-weighted. Includes a lifting tab for easy opening.



code	internal diameter mm	external diameter mm	total length mm
3066		23.30	5.90



Includes a small internal cavity designed to prevent possible drop spillage. Ergonomical. Ribbed for a better handling while using gloves.



code	internal diameter mm	external diameter mm	total length mm
3058	10.60	15.00	15.30



One of the caps offering the largest chamber on the market, thus compensating for the loss of space inside the tube caused by the insertion of a cap.



code	internal diameter mm	external diameter mm	total length mm
3081	13.80	19.68	19.00



It has the same characteristics than the previous cap.



code	internal diameter mm	external diameter mm	total length mm
3082	14.55	20.45	18.50

## 12 ml screw cap tubes, round bottom

Made of **autoclavable (121 °C)** transparent polypropylene or polystyrene. Green cap made of high density polyethylene. **Dimensions:** 15 x 102 mm. The external skirt allows the tubes to remain **free-standing**. Supplied screwed. Recommended volume: 12 ml. The sterile model (ethylene oxide) is supplied individually in flow-pack bag, with indication of batch, expiration date, etc. According to the guidelines for sterile products.

**Attention:** For autoclaving, the cap should be loose on the thread and not tightly fitted.



mod.	code	description	autoclavable	sterile	maximum volume ml	volume recom. ml	case quantity	case weight	case volume	cases pallet
1	301403	polystyrene		no	14.4	12	6 x 250	12.90	0.082	20
	301403.G	polystyrene		STERILE R	14.4	12	6 x 250	12.60	0.086	20
2	301402	polystyrene individually wrapped		STERILE EO	14.4	12	6 x 250	13.40	0.096	16
3	401402	polypropylene individually wrapped	✓	STERILE EO	14.2	12	6 x 250	12.03	0.096	16
4	401403	high transparency polypropylene	✓	no	14.2	12	6 x 250	11.11	0.082	20

Dimensions (±0,09):

code	external cap Ø mm A	external tube Ø mm B	internal tube Ø mm C	length with cap mm D	length without cap mm E
301402, 301403, 301403.G	20.9	16.3	14.4	103.9	102.5
401402, 401403	20.9	16.2	14.3	102.9	101.5

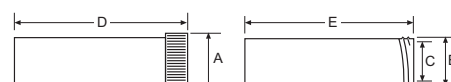

Resistance to centrifugation:  
PS: 7,500 xg. PP: 15,000 xg.



## Sterile culture tubes in polystyrene

Tubes supplied with either a two position ribbed polyethylene cap, which can be left loose for aerobic work or sealed for anaerobic cultures. They are biologically inert, exempt from mold release agents, and at a temperature between **-190°C to 120°C**. Packaged in self-standing resealable zip-lock bags of 125 units.

Resistance to centrifugation: 1,400 xg



Loose position for aerobic work



Sealed position for anaerobic cultures

code	dimensions mm	volume ml	case quantity	case weight	case volume
300807	12 x 75	5	8 x 125	4.24	0.033
300808	17 x 100	14	8 x 125	7.14	0.060





## 15 ml and 50 ml centrifugal tubes

Made of polypropylene, suitable for both clinical and research applications.

Latex and heavy metal free material. **Only non-sterile models are free of DNase, RNase, ATP, human DNA and endotoxins.** High transparency of the material for a clear visualization during experiments specially for molecular biology.

Tube and cap designed with the system of flat threads for complete leakproof. Highly smooth hydrophobic surface for minimum disturbance during centrifugation. Silk-screen black graduation in the tube and large white frosted portion for easy writing.

**Autoclavable at 121 °C.**

Centrifugation resistance: **14.000 xg**, except code **429931: 7.500 xg** and codes **429950, 429951: 3.500 xg**

It is recommended to use adapters to centrifuge and avoid malformations.

Available models: 15 ml non-skirted and 50 ml skirted and non-skirted.

15 ml tubes	50 ml tubes
Ø Exterior: 16,5 mm    Height: 121 mm	Ø Exterior: 29,2 mm    Height: 116 mm



code	description	presentation	sterile	case weight	case volume	cases per pallet
<b>15 ml tubes</b>						
429940	non-skirted tube	500 tubes in bulk	no	500	4.50	0.034
429945	non-skirted tube	20 bag to 25 tubes	no	500	4.50	0.0281
429942	non-skirted tube	20 bag to 25 tubes	<b>STERILE R</b>	20 x 25	4.02	0.04
<b>50 ml tubes</b>						
429930	non-skirted tube	20 bag to 25 tubes	no	500	7.70	0.09
429931	non-skirted tube	20 bag to 25 tubes	<b>STERILE R</b>	20 x 25	7.44	0.108
429950	non-skirted tube	20 bag to 25 tubes	no	500	8.80	0.09
429951	non-skirted tube	20 bag to 25 tubes	<b>STERILE R</b>	20 x 25	8.80	0.108

It is recommended that the centrifuge caps fit in size and shape to the tubes to be centrifuged.



## 15 ml and 50 ml conical tubes

Tubes made of transparent polypropylene, conical bottom. Suitable for centrifugation tests in immunology laboratories, microbiology, etc. With continuous thread and molded external graduation each 0.5 ml in 15 ml tubes, and each 5 ml in 50 ml tubes. Blue polyethylene cap with internal elastic obturation to assure an hermetical closure.

Resistance to centrifugation:

15 ml tubes, non sterile models until **7.000 xg**, sterile models **5.000 xg**. The 15ml tubes have a matt area.

50 ml tubes, non sterile models until **12.000 xg**, sterile models **7.000 xg**.

Sterile models are not suitable for autoclaving.

Non sterile models are **autoclavable at 121 °C**, with the cap positioned on the thread but uncapped.

50 ml tubes have skirted and non skirted models.



code	description	sterile	external cap Ø mm	internal tube Ø mm	external tube Ø mm	length with cap mm	case quantity	case weight	case volume	cases per pallet
<b>15 ml conical tubes</b>										
429910	non sterile	no	20.9	14.35	17	120	500	3.94	0.030	54
429920	100 units in bag	STERILE R	20.9	14.35	17	120	5 x 100	3.90	0.029	54
429946	individually wrapped	STERILE R	20.9	14.35	17	120	500	3.96	0.040	40
<b>50 ml conical tubes</b>										
429900	non skirted	no	34.4	27.2	29.5	117.5	500	7.80	0.072	20
429900SP	non skirted, unscrewed cap	no	34.4	27.2	29.5	117.5	500	7.90	0.082	20
429901	skirted	no	34.4	27.2	29.5	117.5	500	8.50	0.082	20
429926	non skirted, individually wrapped	STERILE R	34.4	27.2	29.5	117.5	500	8.00	0.080	20
429926.25	non skirted, bag 25 units	STERILE R	34.4	27.2	29.5	117.5	20x25	8.30	0.082	20
429926.10	non skirted, bag 100 units	STERILE R	34.4	27.2	29.5	117.5	5x100	7.90	0.082	20
429927	skirted, individually wrapped	STERILE R	34.4	27.2	29.5	117.5	500	8.80	0.082	20
429927.25	skirted, bag 25 units	STERILE R	34.4	27.2	29.5	117.5	20x25	8.80	0.082	20
429927.10	skirted, bag 100 units	STERILE R	34.4	27.2	29.5	117.5	5x100	8.50	0.082	20

It is recommended that the centrifuge caps fit in size and shape to the tubes to be centrifuged.



## New warehouse in Asia

Deltalab member of SCGP, has inaugurated a new warehouse in Thailand, the Deltalab Asia Hub.

This modern storage center, located in a free trade zone in Thai territory, houses products manufactured at the plant in Spain. The Deltalab Asia Hub will serve as a key redistribution point for customers in Southeast Asia and Oceania.

In this way, Deltalab member of SCGP, strengthens its competitive position in the region and significantly improves service to customers in the area.



## GLASS TUBE RANGE

The high quality of our range of disposable glass culture tubes and screw threaded tubes is reflected in the uniformity of their wallthickness, shape of their bottoms, close tolerances, well formed bottoms and well moulded screw-neck. All of our tubes are fully treated at temperatures above **500 °C** to eliminate contamination, reduce breakage and increase strength. The majority of our tubes are packaged in plain outer cases. Each tube is polished individually.

### Culture tubes:

They are available in either borosilicate or soda lime glass. Both glasses differ primarily in their chemical composition and their chemical resistance.

**Borosilicate glass** is a type of glass with a higher resistance to thermal shock. For this reason borosilicate glass is more suitable when tubes are intended to be heated or cooled rapidly.

**Soda lime glass** is a more economical alternative and suits for most culture medium, bacteriological and laboratory applications where the tube will not be subjected to extreme temperature changes.

**Screw-neck tubes** are ideal for tissue culture and general bacteriological work. Tubes are supplied with standard GPI finishes.

**The screw – neck vials** are made of borosilicate glass and are basically used for diagnosis, pharmaceuticals, chemicals, laboratory analysis, storage of liquids and powders. The caps presented are manufactured in autoclavable polypropylene with internal silicone joint.

### Different packagings are available, depending on the model of tube:

**Boxes:** sturdy cardboard boxes. Each box contains small shrink-wrapped cases. Tubes are presented horizontally.

**Trays:** sturdy shrink-wrapped cardboard trays. Tubes are presented vertically.



### Pressure cap for glass tubes

Made of polypropylene, **autoclavable** up to **121 °C**.  
Recommended for glass tubes.  
Codes **916100, 816100, 916150, 816150** and **816160**.  
Vented caps (with inner flats).



code	recommended for tubes Ø mm	colour	case quantity	case weight	case volume
617402	16	naturel	4 x 1,000	5.15	0.059

## Round bottom glass tubes

Made of **borosilicate** or **soda glass**.

The high quality of those tubes is reflected in the uniformity of their wall thickness and of their diameter and height dimensions.

Supplied in small quantities per case for a more convenient use in laboratory.



### Soda tubes

code	total capacity ml	Ø int. mm tube	Ø ext. mm tube	height mm	thickness mm	case quantity	case weight	case volume
<b>Supplied in boxes (1)</b>								
801075	4	8.20	9.75	75	0.60	4 x 250	3.60	0.010
801275	6	10.20	11.60	75	0.60	4 x 250	4.50	0.013
813100	10	11.10	12.70	100	0.60	4 x 250	6.59	0.022
816100	15	13.95	15.75	100	0.60	4 x 250	9.46	0.034
816150	22	13.55	16.00	150	0.70	4 x 250	13.22	0.049
816160	27	14.40	16.00	160	0.55	500	5.50	0.018
818150	28	15.00	18.00	150	0.85	2 x 250	7.30	0.030
820150	34	17.20	20.00	150	0.85	100	1.92	0.006
<b>Supplied in trays (2)</b>								
801175T	6	10.10	11.60	75	0.50	550	1.86	0.005



### Boro tubes

code	glass type	total capacity ml	Ø int. mm tube	Ø ext. mm tube	height mm	thickness mm	case quantity	case weight	case volume
<b>Supplied in boxes (1)</b>									
901075	Boro 5.1	4	8.20	9.75	75	0.60	4 x 250	3.60	0.010
901275	Boro 5.1	6	10.20	11.60	75	0.60	4 x 250	4.50	0.014
913100	Boro 5.1	10	11.10	12.70	100	0.60	4 x 250	5.92	0.022
916100	Boro 5.1	15	13.95	15.75	100	0.60	4 x 250	9.10	0.034
916150	Boro 5.1	22	13.55	16.00	150	0.70	4 x 250	13.60	0.049
918150	Boro 5.1	28	15.00	18.00	150	0.85	4 x 125	7.30	0.040

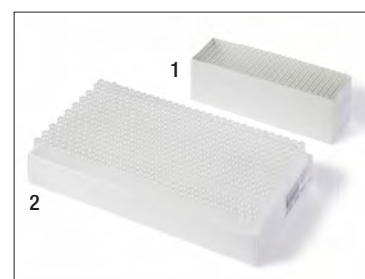

## Screw threaded glass tubes

Made of **borosilicate** or **soda glass**. The high quality of those screw threaded tubes is reflected in the uniformity of their wall thickness and of their diameter and height dimensions. Supplied in small quantities per case for a more convenient use in laboratory. Tubes are supplied without caps. To order caps see below. Polypropylene caps are designed for the round bottom tubes. Aluminum caps are designed for flat bottom tubes.



### Soda glass tubes

code	total capacity ml	screw	Ø int. mm tube	Ø ext. mm tube	height mm	thickness mm	case quantity	case weight	case volume	suitable cap
------	-------------------	-------	----------------	----------------	-----------	--------------	---------------	-------------	-------------	--------------

Flat bottom soda glass tubes supplied in trays

617145	24	CAPALU 16	14.20	17.75	144.5	1.05	252	5.54	0.010	617000
--------	----	-----------	-------	-------	-------	------	-----	------	-------	--------



### Borosilicate glass tubes

code	glass type	total capacity ml	screw	Ø int. mm tube	Ø ext. mm tube	height mm	thickness mm	case quantity	case weight	case volume	suitable cap
------	------------	-------------------	-------	----------------	----------------	-----------	--------------	---------------	-------------	-------------	--------------

Round bottom tubes, supplied in boxes.

713100	Boro 5.1	5	13 - 415	10.65	12.75	100	1.00	4 x 250	9.56	0.021	617100
716100	Boro 5.1	11	15 - 415	14.00	16.00	100	1.05	4 x 250	12.36	0.033	617200
716125	Boro 5.1	14	15 - 415	14.00	16.00	125	1.05	4 x 250	14.91	0.045	617200
716150	Boro 5.1	18	15 - 415	14.00	16.00	150	1.05	4 x 250	17.42	0.047	617200
720150	Boro 3.3	34	18 - 415	17.70	20.00	150	1.15	4 x 125	11.80	0.036	617300



## Screw caps for the above tubes

For round bottom borosilicate glass tubes, choose **polypropylene caps (black colour)**. For flat bottom soda glass tubes, choose **aluminum** caps, with an internal liner made of caoutchouc. Code **617000** incorporates a polypropylene gasket. Pharmaceutical quality.

Both models of caps are fully **autoclavable**.



code	suitable tube	type of cap	bag quantity	bag weight	bag volume
617000*	617145	aluminum	500	0.76	0.003
617100	713100/617145	polypropylene	1,000	0.86	0.005
617200	716100 / 716125 / 716150	polypropylene	1,000	1.50	0.007
617300	720150	polypropylene	500	1.03	0.012

\* Carry polypropylene gasket.



## Flat bottom screw threaded vials

Made of ultra clear borosilicate glass. Fully **autoclavable**.

Supplied in trays individually shrink-wrapped. Thickness: 1 mm. Caps are supplied separately. To order caps see below.



mod.	code	glass type	dimensions mm	volume ml	screw	tray quantity	tray weight	tray volume	suitable cap
1	900204	Boro 5.1	15 x 45	4	13-425	100	0.40	0.0010	917000
2	900205	Boro 4.9	18 x 50	5	15-425	250	1.82	0.0042	918000
3	900211	Boro 5.1	22 x 48	10	18-400	100	0.94	0.0024	922000
4	900212	Boro 5.1	19 x 65	12	18-400	100	1.10	0.0020	922000
5	900220	Boro 4.9	28 x 65	20	22-400	2 x 150	2.70	0.0100	928000
6	900225	Boro 5.1	28 x 70	24	22-400	100	1.52	0.0057	928000

## Caps for the above vials

Made of **autoclavable** polypropylene. Black caps feature an internal silicone joint.

mod.	code	screw	bag quantity	bag weight	bag volume
A	917000	13-425	100	0.11	0.0003
B	918000	15-425	250	0.32	0.0006
C	922000	18-400	250	0.53	0.0026
D	928000	22-400	300	0.98	0.0062



## Racks for containers up to 23 mm Ø

Made of stainless steel. 25 mm square holes.

Features a strong woven mesh base.



See other racks for tubes in chapter **Sample Storage**



code	large x width x height mm	tubes capacity	quantity	weight	volume
D-200	265 x 265 x 85	100 (10 x 10)	1	0.50	0.0078
D-230	219 x 166 x 85	48 (8 x 6)	1	0.26	0.0042
D-240	165 x 110 x 85	24 (6 x 4)	1	0.16	0.0020
D-250	111 x 84 x 85	12 (4 x 3)	1	0.10	0.0013

### 0.4 ml microtubes, Beckman® type

Manufactured in polyethylene.

It can be used at temperatures from **-50 °C to 75 °C**.

**Dimensions:** 5.50 x 47.50 mm (Ø x h), capped.

Withstand centrifugation up to **11,000 xg**



See our wide range of racks for microtubes in chapter **Sample Storage**



code	description	case quantity	case weight	case volume
900007	Beckman® type microtube 0.4 ml	1,000	0.63	0.004

### 0.5 ml microtubes, Vitatron® type

Manufactured in polypropylene.

**Autoclavable.** Graduated.

Easy handling caps: they can be opened and closed with one hand.

**Dimensions:** 7.87 x 31.8 mm (diameter x height) capped.

Withstand centrifugation up to **14,000 xg**



code	description	case quantity	case weight	case volume
900118	Vitatron® type microtube 0.5 ml	12 x 1,000	7.00	0.052

### 0.5 ml microtubes, Vitatron® type

Made of **autoclavable** polypropylene. Ideal for little sample volumes, microtechniques, microsedimentation, etc.

Suitable for transport, storage and freezing of biological samples.

Watertight closing system. Easy handling caps: they can be opened and closed with one hand.

Easily pierceable.

The rim in the inner part of the cap assures an optimum watertightness.

Resist temperatures from **-10 °C to 130 °C**.

**Dimensions:** 7,50 x 31,25 mm (Ø x h) capped.

Will withstand centrifugation up to **11,000 xg**.

code	description	case quantity	case weight	case volume
900117	Vitatron® type microtube 0.5 ml	14 x 1,000	7.30	0.069





### 0.5 ml microtubes

Made of ultra clear polypropylene. **Autoclavable.** Tubes have a frosted writing surface one side and on the closure area for better sample identification. Caps are easy to handle and can be opened and closed with one hand. Lids are easily pierceable. Tubes have moulded-in graduations in 100 ul increments from 0.1 to 0.6 ml.

Model **4092.1NS**, with a low adhesion surface, is specially designed for research procedures such as protein work and nucleic acid amplifications.

Made from special resins to minimise liquid retention and ensure optimum sample yield, thus eliminating the use of lubricants that may be harmful to samples. The proprietary formulation is completely **non-reactive**.

**RNase, DNase and PCR inhibitors free.**

Can be used from **-80 °C** to **121 °C**.

**Dimensions:** 30 x 8 mm.

Will withstand centrifugation up to **17,000 xg**.



code	description	case quantity	case weight	case volume
<b>4092.1N</b>	natural graduated	10 x 1,000	7.28	0.053
<b>4092.1NS</b>	low adherence natural graduated	10 x 500	3.42	0.028

Minimum order quantity: 1000.

### Standard 1.5 ml microtubes

Made of ultra clear polypropylene. **Autoclavable.**

Attached flat caps.

Tubes can be easily opened and closed with one hand. Ideal for the storage and freezing of any kind of biological material (cells, sperm, bacteria, etc.).

Can be used at temperatures down to **-100 °C**.

Will withstand centrifugation up to **21,000 xg**.



code	dimensions Ø x h mm	colour	case quantity	case weight	case volume
<b>200400</b>	10.86 x 39.06	natural	5 x 1,000	5.40	0.051
<b>200401</b>	10.86 x 39.06	yellow	5 x 1,000	5.40	0.051
<b>200405</b>	10.86 x 39.06	blue	5 x 1,000	5.40	0.051
<b>200407</b>	10.86 x 39.06	green	5 x 1,000	5.40	0.051
<b>200410</b>	10.86 x 39.06	orange	5 x 1,000	5.40	0.051

### 1.5 ml microtubes

Manufactured in polypropylene. **Autoclavable.**

Easy opening and closing.

**Graduated** tube.

It features a frosted area for writing. Flat cap.

Will withstand centrifugation up to **21,000 xg**.



code	dimensions Ø x h mm	case quantity	case weight	case volume
<b>200400P</b>	10.2 x 39.9	12 x 500	7.4	0.055

### 1.5 ml safety lock microtubes

Made of ultra clear polypropylene. Featuring a special "snap-seal" secure lock. A special locking clasp with a distinctive audible snapseal design ensures tubes will not open during centrifugation. Tubes have a frosted writing surface one side and the attached closure for better sample identification.

Caps are easy to handle and can be opened and closed with one hand. Lids are easily pierceable. Tubes have moulded-in graduations in 0.5 ml increments. Resistant between -86 °C and 121 °C.

**Autoclavable.**

Withstand centrifugation up to **15,000 xg**.



code	dimensions Ø x h mm	case quantity	case weight	case volume
4092.4N	11 x 39	10 x 500	7.00	0.046

### Premium 1.5 microtube. Safety lock

Same features as code 4092.4N besides is **free of DNA, DNase, RNase and pyrogens**.

**Autoclavable.** Can be used from -90 °C to 121 °C.



Withstand centrifugation up to **20,000 xg**.



code	dimensions Ø x h mm	case quantity	case weight	case volume
4092.5N	11 x 39	500	5.76	0.055

### 1.5 microtubes with secure lock pick-up tab

Same characteristics as code 4092.5N but these microtubes include a pick-up tab for easier handling without actually touching the tube.

Pierceable cap.

**Autoclavable.**

Withstand temperatures from -175 °C to 121 °C.

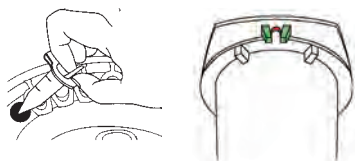

Withstand centrifugation up to **17,000 xg**.



code	colour	case quantity	case weight	case volume
4091.1N	natural	500	4.94	0.045



### 1.5 ml graduated microtubes. DNase, RNase free

Made of ultra clear polypropylene.

**Autoclavable.**

Featuring a frosted writing surface on the side and on the closure area for better sample identification. Caps are easy to handle and can be opened and closed with one hand. Lids are easily pierceable.

Can be used from **-170 °C to 121 °C**.

Dimensions: 39 x 11 mm.

Caps specially designed to reduce popping when centrifugation, freezing, boiling, storing or shipping is required.

- when the objective is to avoid liquid remaining on the wall of the tube, just push the cap slightly and a little centrifugation time is required.
- when centrifugation is required, push the cap firmly to achieve complete closure.

**Certified RNase and DNase free.**

Withstand centrifugation up to **20,000 xg**.



code	colour	case quantity	case weight	case volume
4092.2N	natural	10 x 500	6.82	0.048

Other colours under request. Minimum order quantity: 500.

### 1.5 ml microtubes. DNase, RNase free

Made of ultra clear polypropylene. **Autoclavable.**

Attached flat caps.

**Graduated** from 100 µl.

Tubes can be easily opened and closed with one hand. Ideal for the storage and freezing of any kind of biological material (cells, sperm, bacteria, etc.).

Can be used at temperatures from **-90 °C to 121 °C**.

**DNase, RNase, DNA and PCR inhibitors free.**

Dimensions (Ø x h): 10.7 x 39.1 mm.

Withstand centrifugation up to **20,000 xg**.



code	colour	case quantity	case weight	case volume
4092.3N*	natural colour	10 x 500	6.77	0.054
4092.3NS	natural colour, clear siliconised	10 x 250	3.70	0.026

### 2 ml microtubes with attached caps

Made of ultra clear polypropylene. **Autoclavable.**

**Certified RNase and DNase free. Pyrogen-free.**

Featuring a frosted writing surface on the side and on the closure area for better sample identification. Easy handling: tubes can be opened and closed with one hand.

Lids are easily pierceable.

Tubes have moulded-in graduations in 100 µl increments up to 2 ml.

Dimensions: 9 x 40 mm. Can be used at temperatures from **-90 °C up to 121 °C**.

Model **4092.6NS** has a low adhesion surface for special applications such as protein work.

Withstand centrifugation up to **17,000 xg**.



code	colour	case quantity	case weight	case volume
4092.6N	natural colour	10 x 500	7.27	0.053
4092.6NS	natural colour, clear siliconised	10 x 250	4.09	0.036

Minimum order quantity: 500 and 250 units respectively.

## 2 ml graduated microtube

Microtubes made of ultra clear polypropylene. **Autoclavable.**  
2 ml graduated tubes with frosted area for writing.  
Flat cap that features a secure lock with safety shield.  
Easy handling with just one hand.  
They can be used at temperatures from **-86 °C** up to **121 °C**.

Withstand centrifugation up to **10,000 xg**.



Please find racks for these microtubes on chapter  
**Sample Storage**



code	dimensions Ø x h mm	case quantity	case weight	case volume
4092.7N	10.3 x 40.5	10 x 500	5.89	0.056

## 5 ml graduated microtube

5 ml microtubules are the perfect choice for intermediate volume between microcentrifuge tubes and 15 ml conical tubes.  
Made of transparent polypropylene. The microtubes are graduated each 250 µL and are supplied with a matte band able to write in.  
Flat cap is attached to the tube. Easy handling: microtube can be opened and close with one hand.  
Can be used from Resistant to temperatures from **-80 °C** to **121 °C**.  
**Autoclavable. Free of DNA, DNase, RNase and PCR inhibitors.**

Withstand centrifugation up to **25,000 xg**.



See **M-015** pag. 220



code	dimensions Ø x h mm	case quantity	case weight	case volume
4092.8N	1.9 x 6	250	0.813	0.0078





# 07. COLD STORAGE

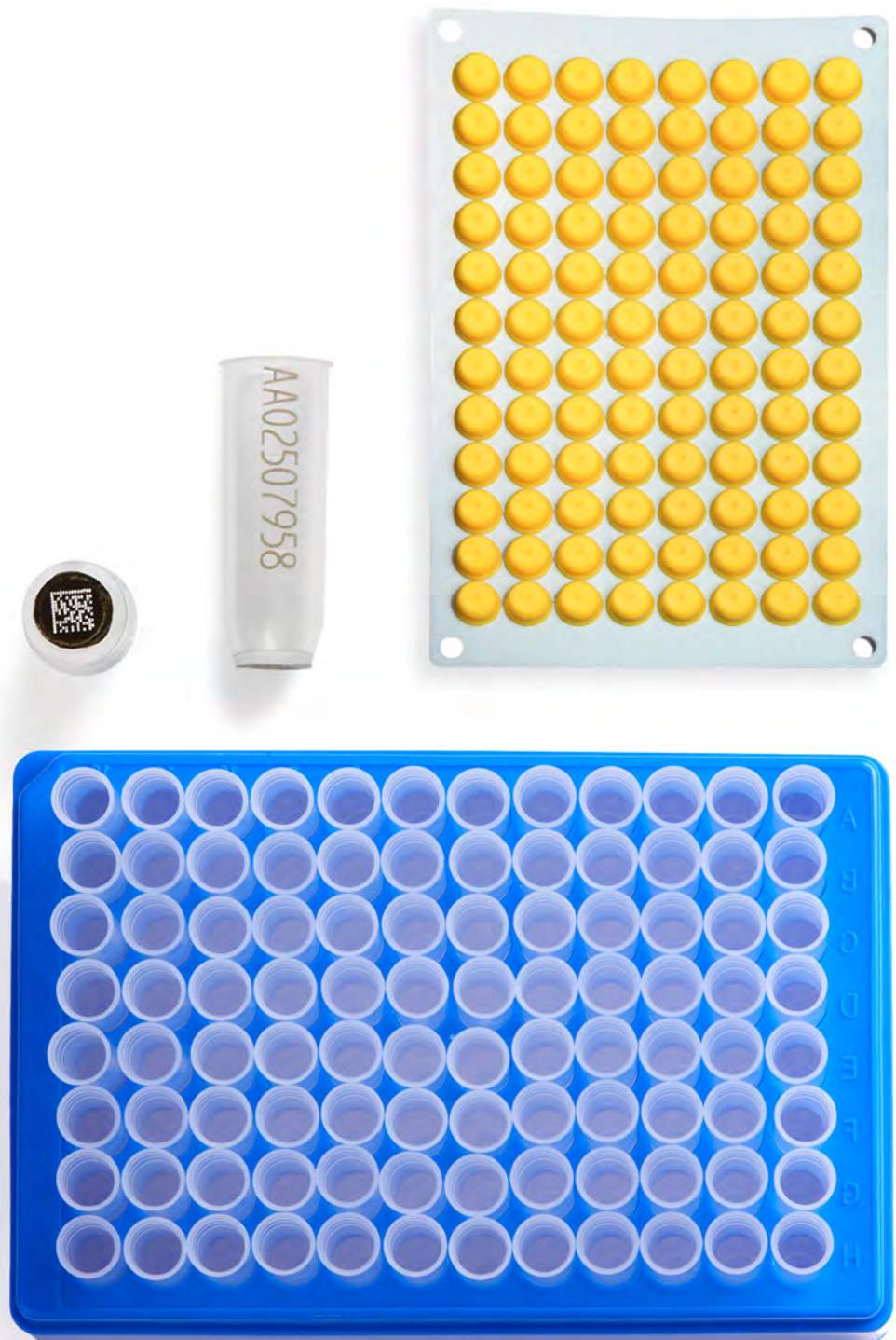



## Screw thread microtubes

Made of **autoclavable** polypropylene, they can be used at extreme temperatures from **-190 °C to +121 °C**. Two versions available: in transparent polypropylene, or opaque brown (**UV resistant**, designed to be used with light sensitive samples). Caps are supplied separately, see below. Dimensions: 11 x 44 mm.

Tubes and caps Can be centrifuged at **17.000 xg**.



mod.	code	volume ml	skirt	case quantity	case weight	case volume
<b>Transparent polypropylene</b>						
1	409110.1	0.5	yes	1,000	1.47	0.010
2	409110.2	1.5	yes	1,000	1.45	0.009
3	409110.3	1.5	no	1,000	1.42	0.009
4	409110.4	2.0	yes	1,000	1.30	0.010
<b>Brown polypropylene</b>						
5	409113.1	0.5	yes	1,000	1.54	0.009
6	409113.2	1.5	yes	1,000	1.34	0.009
7	409113.3	1.5	no	1,000	1.43	0.009
8	409113.4	2	yes	1,000	1.34	0.009

## Caps for screw thread microtubes

Made of polypropylene. Caps are available either with an attachment loop or without loop. Both models have a sealing O-ring (red) of silicone to ensure a positive leakproof seal.

Cap dimensions: 13 x 8 mm.

Certified RNase, DNase.



mod.	code	description	case quantity	case weight	case volume
<b>Transparent polypropylene</b>					
1	409007.N	cap with loop	1,000	0.41	0.003
2	409008.N	cap without loop	1,000	0.40	0.002
<b>Brown polypropylene</b>					
3	409007.M	brown cap with loop	1,000	0.45	0.003
4	409008.M	brown cap without loop	1,000	0.55	0.010

## Screw cap microtubes, with cap. Sterile

Tubes and caps in medical grade, transparent polypropylene. The cap embodies a non-reactive ethylene-propylene o-ring. Suitable for **autoclave, liquid nitrogen (gas) and boiling processes**. Perfect for long term storage.

Withstand temperatures from **-190 °C**.

Graduated models feature a frosted area for writing.

The non-graduated model incorporates an external grip for an easy handling. Microtubes are supplied capped, in bags of 50 units.

Withstand centrifugation at **20.000 xg**.



code	description	sterility	graduation	case quantity	case weight	case volume
409115/4	0.5 ml skirted	STERILE R	no	50 x 50	5.90	0.030
409115/2	1.5 ml non skirted	STERILE R	yes	50 x 50	5.90	0.030
409115/6	2 ml skirted	STERILE R	yes	50 x 50	5.90	0.030
409115/3	2 ml non skirted	STERILE R	yes	50 x 50	5.90	0.030



COLD STORAGE



## Screw thread microtubes

Made of transparent polypropylene. Suitable for use in liquid nitrogen, **autoclave** and for boiling applications, and can be used at temperatures down to **-190 °C**. **Certified RNase, DNase and PCR inhibitors free.**

Products ideal for long term sample storage. The codes **409111/4**, **409111/5** and **409111/6**, with external moulded slots for better handling with gloves.

Dimensions: 10.3 x 44.5 mm (except code **409111/2**: 10.3 x 43.6 mm).

Caps are supplied separately, see below.

Withstand centrifugation at **20.000 xg**.

mod.	code	description	graduation	case quantity	case weight	case volume
1	<b>409111/4</b>	0.5 ml skirted	no	500	0.78	0.005
2	<b>409111/2</b>	1.5 ml	yes	500	0.61	0.005
3	<b>409111/5</b>	1.5 ml skirted	no	500	0.73	0.005
4	<b>409111/3</b>	2.0 ml	yes	500	0.71	0.005
5	<b>409111/6</b>	2.0 ml skirted	no	500	0.76	0.005
6	<b>409111/7</b>	2.0 ml skirted	yes	500	0.73	0.005

## Caps for screw thread microtubes

Made of medical grade polypropylene. Feature an internal O-ring to ensure leakproof seal. Dimensions 13.0 x 6.0 mm.

**Certified RNase, DNase and PCR inhibitors free.**

code	colour	case quantity	case weight	case volume
<b>409112/0</b>	natural	500	0,21	0,0009
<b>409112/1</b>	blue	500	0,21	0,0009
<b>409112/2</b>	green	500	0,21	0,0009
<b>409112/4</b>	red	500	0,21	0,0009
<b>409112/6</b>	yellow	500	0,21	0,0009



## Screw thread tamper evident microtubes

Microtubes and caps are made of autoclavable ultra clear polypropylene. Ribbed cap with internal silicone O-ring for a positive **leakproof seal**. Super fast ¼ turn thread design. **Tamper evident** seal which notices if microtube has been opened. **Rnase, Dnase and Pyrogen free.** They can be used at extreme temperatures from **-196 °C** to **121 °C**. **Microtube dimensions:** 11 x 44 mm.

**Cap dimensions** (with tamper-evident ring): 15 x 9 mm.

Used on:

- Test of fertility and DNA testing
- Packaging of diagnostic kits and reagents
- Forensic laboratories

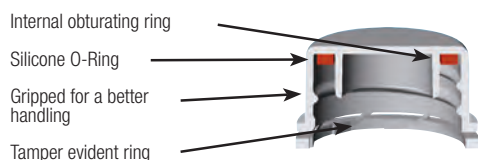

Withstand centrifugation at **17.000 xg**.



mod.	code	volume ml	case quantity	case weight	case volume
1	<b>409110.4T</b>	2	1,000	2.06	0.013
2	<b>409110.2T</b>	1.5	1,000	2.06	0.013



COLD STORAGE



## STERILE CRYOVIALS

Tubes made of **autoclavable** polypropylene. Designed for the storage of biological material at temperatures as low as **-196 °C**. (Liquid Nitrogen but in gas state). Cryovials have printed graduations and feature a white marking area for sample identification. Caps and tubes have both the same coefficient of expansion, which further enhances their leakproof qualities at changing temperatures. Caps are manufactured in polyethylene<sup>1</sup> and embody a silicone O-ring that guarantees leakproof. Colour code inserts can be fitted into the caps for identification. **All cryovials are certified RNase, DNase and pyrogen free.** Cryovials are **sterilized by radiation** and are packaged in safety-lock bags of 100. Supplied capped.



### Cryovials with external threads

Minimize liquid retention. Non skirted versions withstand centrifugation up to **17,000 xg**.

110 ml cryovial (code **401410**) features a polyethylene cap which does not accept inserts.



mod.	code	volume ml	skirt	dimensions mm*	case quantity	case weight	case volume
1	<b>409105.1</b>	1.2	yes	12.5 x 42	10 x 100	2.50	0.014
2	<b>409103.1</b>	2.0	no	12.5 x 47	10 x 100	2.70	0.017
3	<b>409106.1</b>	2.0	yes	12.5 x 49	10 x 100	2.68	0.015
4	<b>409107</b>	3.0	yes	12.5 x 71	10 x 100	3.88	0.023
5	<b>409108</b>	4.0	yes	12.5 x 77	10 x 100	3.90	0.028
6	<b>409109</b>	5.0	yes	12.5 x 92	10 x 100	4.60	0.023
7	<b>401410</b>	10.0	yes	17.0 x 84	10 x 50	2.80	0.020

\* Capped.

### Cryovials with internal threads

Non skirted versions withstand centrifugation up to **14,000 xg**.



See racks at page 216



mod.	code	volume ml	skirt	dimensions mm*	case quantity	case weight	case volume
1	<b>409001</b>	1.2	yes	12.5 x 41	10 x 100	1.94	0.015
2	<b>409002</b>	2.0	no	12.5 x 48	10 x 100	2.22	0.016
3	<b>409002.1</b>	2.0	yes	12.5 x 49	10 x 100	2.24	0.015
4	<b>409003</b>	4.0	no	12.5 x 70	10 x 100	3.79	0.028
5	<b>409003.1</b>	4.0	yes	12.5 x 72	10 x 100	3.90	0.028
6	<b>409003.2</b>	5.0	no	12.5 x 90	10 x 100	4.60	0.024

\* Capped.

### Colour coded inserts

Made of polypropylene. Very convenient for colour identification in freezers, on benchtops etc. Fit precisely into the caps of cryovials. They feature a little hole in order to help removing them from the cap. Not suitable for code **401410**.

code	colour	case quantity	case weight	case volume
<b>409003A</b>	blue	500	0.08	0.0005
<b>409003AM</b>	yellow	500	0.08	0.0005
<b>409003R</b>	red	500	0.08	0.0005
<b>409003V</b>	green	500	0.08	0.0005



COLD STORAGE



## NON STERILE CRYOVIALS WITH EXTERNAL THREADS

Made of polypropylene. Designed for the storage and transportation of biological material. The external thread design provides a smooth and uniform inner surface, thus reducing the risk of contamination. Tubes can be **autoclaved to 121 °C** and withstand temperatures down to **-190 °C**. The closures and tubes are both manufactured of polypropylene having the same coefficient of expansion, which further enhances their leakproof qualities at changing temperatures. Cryovials withstand centrifugation up to **17,000 xg**. Skirted tubes are not recommended for centrifugation. Available with or without graduation and white band. Caps suitable for these cryovials are supplied separately, see code **409110** and series.

### Cryovials printed without graduation



code	volume ml	skirt	dimensions mm*	case quantity	case weight	case volume
409102.1	1.2	yes	12.5 x 43	1,000	1.38	0.007
409106.2	2.0	yes	12.5 x 49	1,000	1.72	0.007
409107.1	3.0	yes	12.5 x 72	1,000	2.48	0.020
409108.1	4.0	yes	12.5 x 76	1,000	2.89	0.018
409109.1	5.0	yes	12.5 x 93	1,000	3.67	0.026

\* Capped

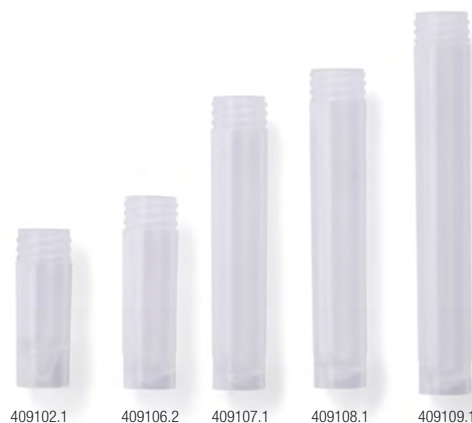

### Cryovials with graduation and band



code	volume ml	skirt	dimensions mm*	case quantity	case weight	case volume
409132	2.0	yes	12.5 x 49	1,000	1.69	0.009
409135	4.0	yes	12.5 x 76	1,000	2.92	0.018

\* Capped



### Caps for the above tubes

Made of polypropylene. Featuring a long skirt and a special thread design allowing them to be removed or sealed with a single turn and assuring a better protection of the content. A silicone washer ensures a positive leakproof seal at all temperatures. Caps are made of polypropylene having the same coefficient of expansion as the above cryovials. See the previous page for colour inserts to fit into these caps.

code	colour	case quantity	case weight	case volume
409110	natural	1,000	0.80	0.004
409110/1	blue	1,000	0.79	0.004
409110/4	red	1,000	0.79	0.004



### Canes for cryovials

Made of aluminum. Suitable for the storage of five or six 1.2 or 2.0 ml tubes in liquid nitrogen freezers such as Dewar flasks.

code	dimensions mm	case quantity	case weight	case volume
409120	290	12	0,11	0,001



COLD STORAGE

## SOLUTIONS FOR CRYOPRESERVATION



Wilmut offers a **wide range of biological sample storage tubes** that fit in the 96-well plate SBS standard format, and single tubes which are compatible with any freezing box format.

With volumes in between 0.5 ml and 1 ml and different options of codification that allows Wilmut system **adapt to the needs of any laboratory or biobank**. They are products designed and oriented exclusively to the user.

### Main features

- It is the tube with more capacity in the minimum space: maximum space optimization of the freezers (from 15 % to 75 % of space saving)
- Maximum traceability: 2D datamatrix code, legible code at the tube, and bar code in the rack
- Traceability files available at [www.wilmut.es](http://www.wilmut.es) or using software management

#### WILMUT tubes:

Made with high quality polypropylene, with volume indicator in the tube, **autoclavables at 121 °C** and allows storage up to **-86 °C**.

#### WILMUT Cryoboxes:

Polypropylene Cryoboxes with standard SBS 96-well format with security closers easy to open even when are frozen.

#### Accessoires WILMUT:

Wilmut has a large range of accessories to complete the range of coded and non coded tubes: caps, lockers, cappers, decappers, labels, scanners, etc.

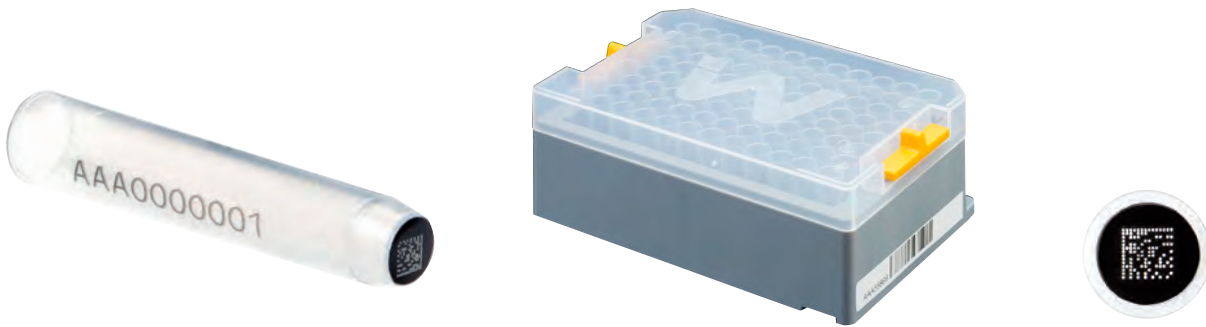

### Non Coded Tubes

#### Wilmut Seroteca (W-SER)

For users who need to process and store biological samples. Low adherence PP, low cytotoxicity and extractable levels, and **DNase, RNase, human DNA and endotoxines free**.



code	gross volume ml	net volume ml	presen- tation	min. order quantity	case quantity	case weight	case volume
W051100	0.65	0.5	bag	960 u	40 x 960	12.90	0.096
W121100	1.4	1	bag	960 u	20 x 960	7.14	0.096

\* 20 racks to 96 tubes and 12 racks to 96 tubes.

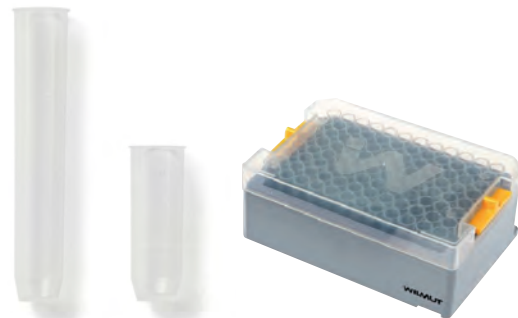

#### Wilmut Eco (W-ECO)

Low adhesion PP, low levels of cytotoxicity and extractables.



code	gross volume ml	net volume ml	presen- tation	min. order quantity	case quantity	case weight	case volume
W058100	0.65	0.5	bag	960 u	40 x 960	12.50	0.096
W128100	1.4	1	bag	960 u	40 x 960	11.90	0.096
W128960	1.4	1	rack	10 x 96*	10 x 96	1.62	0.006

\* 10 racks to 96 tubes.



COLD STORAGE

## Tubes with W-2D Datamatrix coding

Designed for laboratories and biobanks that need maximum security and requirements on the traceability and management of their samples.

W-2D tubes simplify the identification and traceability of the samples during the processing, storage and sending, while offering the highest standards of quality. We present a range of 0.65 ml and 1.40 ml volume tubes, with the possibility of choosing the type of coding that suits the laboratory requirements the best.

- **Laser engraved codes.** The codes are laser engraved directly on each tube so that the codes are permanent, non-transferable and unique.
- **2D Datamatrix coding on the tube.** For an automatic management of traceability using any scanner.
- **Human readable alphanumeric coding on the side of the tube.** For a visual confirmation of the traceability without the need of a scanner.
- **Solid one-piece construction.** Avoids the use of tags or liners that can rip or come off at low temperatures or because of an accidental fail.
- **DNase, RNase, human DNA and Endotoxines free.** Certified by an accredited external laboratory.
- **Low adherence in the interior of the tube.** Manufactured with low binding polypropylene to allow the lowest retention in the tube.
- **Volume visual indicator of the tube.** From 0.5ml to 1ml. Allows a visual identification of mistakes in the dispensation of volume.



code	description	gross volume (ml)	net volume (ml)	sales unit	weight	volume
<b>Bag tubes</b>						
W053100	Tube W-2DST 0,65 ml	0,65	0,50	960 u.	12,90	0,096
W123100	Tube W-2DST 1,40 ml	1,40	1,00	960 u.	11,90	0,096
<b>Rack tubes with cryo label</b>						
W053960CL	Tube W-2DST 0,65 ml	0,65	0,50	20 racks of 96	12,00	0,055
W123960CL	Tube W-2DST 1,40 ml	1,40	1,00	12 racks of 96	12,78	0,060

## W-2DRP | Tubes with coding and Right Position System

W-2DRP tubes have an exclusive coding system that visually links the tube code with the rack code and moreover every tube has a defined position on the rack.

### MANAGEMENT OF TRACEABILITY

- Downloading of data files through the website. Avoids the scanning of the rack to register it in the management software downloading a file through the data file of the rack, which includes the codes and position of the tubes in the rack.
- Files are compatible and can be integrated with the management software and the aliquot equipment.
- Editable files in excel or TRX format to print or save.
- File management by reading the code of the tube or rack. There are 2 options: manual introduction of the code or by the reading of the rack barcode.

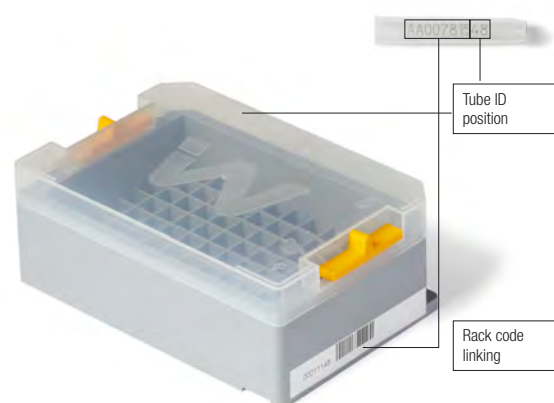

code	description	gross volume (ml)	net volume (ml)	sales unit	weight	volume
W052960CL	Tube W-2DRP 0,65 ml	0,65	0,50	20 racks of 96	12,00	0,055
W122960CL	Tube W-2DRP 1,40 ml	1,40	1,00	12 racks of 96	12,78	0,060



COLD STORAGE



## W-RACK 96 Cryoboxes (empty)

Made with high quality PP, resistant up to **-86 °C** and autoclavable at **121 °C**.



code	description	case quantity	case weight	case volume
W000050	cryobox for 0.65 ml tube	18	1,14	0,0069
W000120	cryobox for 1.4 ml tube	10	1,14	0,0069
W000059CL	coded cryobox for 0.65 ml tube	18	1,14	0,0069
W000129CL	coded cryobox for 1.4 ml tube	10	1,16	0,0069

The cryoboxes are supplied with cryolabel compatible with liquid handling robots.



## PET 8 strip caps polyethylene

High quality polyethylene 8 strip caps.

code	presentation	case quantity	case weight	case volume
409005	bag 120 u	5 x 120	0.80	0.008

## Plug Style caps W-SEAL

Made with high quality TPE that assures a perfect adjustment with the tube and an hermetic sealing at temp. to **-86 °C**.

Available in different colors for visual sample identification.

**DNase, RNase, human DNA and endotoxins free.**



code	presentation	colour	case quantity	case weight	case volume
W999600	sheet 10x96	light green	10 x 96	6.08	0.026
W999601	sheet 10x96	blue	10 x 96	6.08	0.026
W999602	sheet 10x96	black	10 x 96	6.08	0.026
W999603	sheet 10x96	red	10 x 96	6.08	0.026
W999604	sheet 10x96	yellow	10 x 96	6.08	0.026
W990000	bag 960 u	light green	960	9.21	0.026
W990001	bag 960 u	blue	960	9.21	0.026
W990002	bag 960 u	black	960	9.21	0.026
W990003	bag 960 u	red	960	9.21	0.026
W990004	bag 960 u	yellow	960	9.21	0.026

## 2D and 1D manual code reader W-READER

Scan of tubes, boxes, or cryoracks one by one.

They are supplied with a support that allows their use in an automatic way.

Allows the reading of codes on shiny surfaces.

code	description	case quantity	case weight	case volume
W001400	USB code reader	1	0.76	0.003



COLD STORAGE

## Metalic cryoracks for sample storage

Made with high quality materials compatible and adaptable to any storage format: boxes, racks, tubes, moulds, etc., and all types of cryostorage equipment: refrigerators, freezers, deep freezers, nitrogen tanks, walk in cool rooms, etc. We produce all sort of metallic racks: vertical, horizontal, cell system racks, tray racks, etc., including also customized solutions to adapt to the customer needs.

### Horizontal metal racks

Horizontal racks in hi-performance stainless steel type AISI 304. With FB system of no-slip trays for easy storage and search of samples. Maximum size of the boxes to storage: 55mm height and 136 mm width

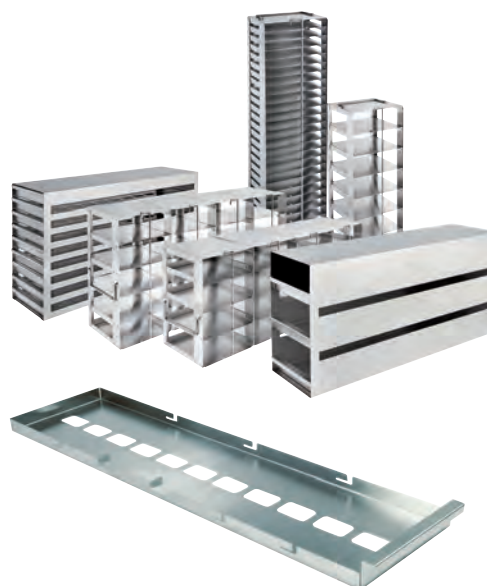

code	number of trays	measures (Z x Y x X) mm	type A boxes capacity (90x130)	type B boxes capacity (135x135)	type C boxes capacity (135x270)	weight	volume
FB534S	4	234 x 427 x 140	16	12	4	3.50	0.050
FB545S	5	290 x 565 x 140	30	20	10	4.80	0.050

Handmade production enables Deltalab to manufacture racks customised to your own specifications. For more information contact our sales department

## W-Coat

Vegetal fiber storage boxes for biological samples to temp down to **-196 °C** (phase vapour). Made with a spetial moisture repelent coating to ensure greater durability. They are supplied assembled and include divider. Size: 133 x 133 mm.

code	colour	height mm	dividers	cells Ø mm	case quantity	case weight	case volume
<b>With divisors</b>							
W350900	white	50	9x9	13	36	3.50	0.034
W370900	white	75	9x9	13	36	3.50	0.034
<b>Without divisors</b>							
W350990	white	50	no	-	36	2.80	0.034
W370990	white	75	no	-	36	2.80	0.034
W310990	white	100	no	-	36	2.80	0.034

\* Available in other colours and number of cells for different diameter tubes. Check with our sales department.



COLD STORAGE

## Dividers to W-Coat and W-Coat AIY

Size: 133 x 133 mm. White colour.

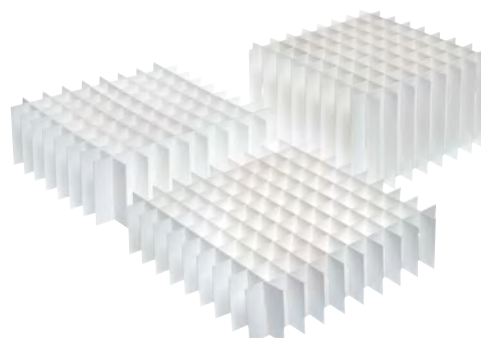

code	dividers	cells Ø mm	height mm	case quantity	case weight	case volume
W030940	9 X 9	13	40	36	0.81	0.0050

For other dimensions, contact our sales department.

## Sample storage system

96 round bottom tubes, supplied in twelve strips of eight tubes each, held in a rack with lid. Rack, lid, tubes and caps are made of **autoclavable** polypropylene, manufactured with the **SBS** standard footprint. Compatible with all robotic applications and multichannel pipetting systems.

Alphanumeric numbered wells, indelibly printed in black, allowing identification in short light conditions. **DNase, RNase, DNA and PCR inhibitors free.** Used for serial dilutions, mixing, storage and harvesting of cells, cell growth for cell culture assays and DNA screening, and as an ideal long-term storage system. Caps are sold separately in strips of eight units; every cap has a tag to make an easy opening and closing.

Tube dimensions (height): 8 x 44 mm

Rack dimensions (with lid): 128 x 86 x 48 mm



code	description	case quantity	case weight	case volume
409009	rack with 96 tubes (8 x 12)	10	1,63	0,010
409010	strips of 8 tubes each	125 strips	0,27	0,007
409011	strips of 8 caps each	125 strips	0,11	0,012
409012	loose tubes	1.000	0,63	0,005



## Sample storage system

Compact sample storing system. It consists on a blue rack with a translucent lid, holding 96 loose round bottom tubes (1,2 ml) arranged in 8 x 12. Robotics suitable version (**RC845TP**). **Autoclavable** and stackable, it resists up to **-100 °C**, and embodies a moulded alphanumeric identification.

Rack, lid and tubes made of polypropylene. Caps made of low density polyethylene.

Caps are sold apart in strips of eight units; every cap has a tag to make an easy opening and closing.

Tube dimensions (height, closed): 8,8 x 45 mm.

Rack dimensions (with lid): 118 x 82 x 50 mm.

**DNase, RNase free. \*Pyrogen Free.**



code	description	case quantity	case weight	case volume
RC845TP*	rack with 96 tubes for robotics	10	1,14	0,010
409005	strips of 8 caps each	120 strips	0,16	0,002
845	tubes in bulk	1.000	0,60	0,004



COLD STORAGE

## Sample storage system

It consists on a white rack and a transparent lid, with 96 tubes (12 x 8) 1.2 ml (capped, 1.1 ml).

Tubes and rack are manufactured in polypropylene, being autoclavable.

Caps in non **autoclavable** polyethylene.

Caps are acquired apart, in strips on eight units.

It is ideal to work with robots and multichannel pipetting systems, as well as for sample transport, storage, or freezing (it can withstand up to **-80 °C**).

It stands up the majority of chemical agents.

Both lid and rack embody an alphanumeric identification. The top left edge of the lid is cut for an exact orientation.

**Tube dimensions (capped):** 9 x 48 mm.

**Rack dimensions (with lid):** 126 x 81 x 53 mm.

According to **SBS** standard.



code	description	case quantity	case weight	case volume
409004	rack with 96 tubes (8 x 12)	10	1,80	0,009
408002	tubes of 8 caps each	120 strips	0,73	0,005
408005	strips of 8 caps each	120 strips	0,09	0,001
408003	loose tubes	5 x 960	3,88	0,028

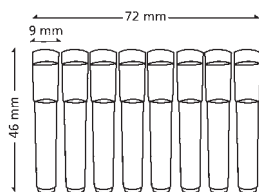

COLD STORAGE





# 08. LIQUID HANDLING



Our range of tips meet almost every liquid handling need, as they are available in a wide scope of options:

- Made of polypropylene
- With or without filter in bulk or rack (with hinged, sliding, or free lid).
- Sterile, DNase and RNase free, with Standard or Extra filter, in rack.
- Sterile, without filter, packed in individual bag.

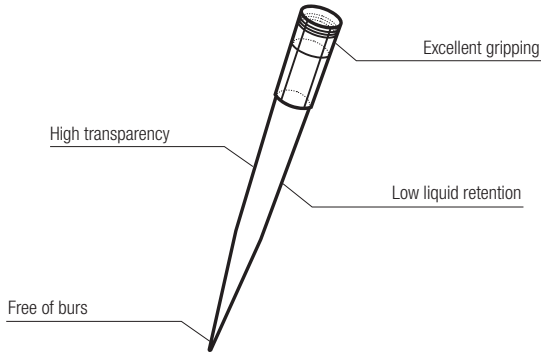

### Tips without filter

The perfect aid for a **safe, easy, quick and accurate** liquid handling.

- Low retention
- Autoclave resistant
- Good subsection
- High transparency
- Uniformity
- Free of metals
- Traceability

Our self-manufactured tips are compatible with most pipettes available on the market. For each model in this catalog, we specify its compatibility with the main pipette brands. However, it is important to note that pipette cones from the same brand may vary depending on the model or year of manufacture. We recommend that users consult with our sales department or request samples before using the tips with new pipette models.

### Types of presentation



Individually wrapped flow-pack



Tips in bulk

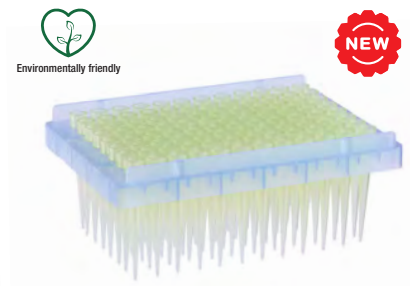

Refill for reusable racks



Rack for tips



Rack for long tips



Rack for macro tips

All our tips and racks are made of **autoclavable** polypropylene, although it is not recommended to autoclave tips with filters.

If you autoclave tips without filters, it is recommended to do so in the rack to avoid deformations.

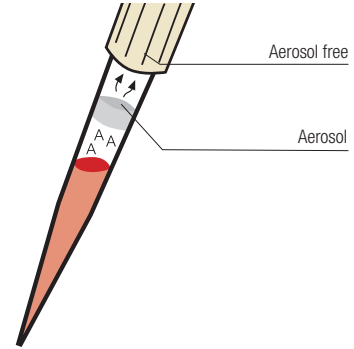

### Tips with filter

The filter tip avoids aerosols and prevents pipette and / or sample contamination.

1. It **purifies the air** that goes through the filter, **removing aerosol and contaminants**
2. It partially **absorbs the sample** in case of overaspiration (10-20%)
3. It **protects the sample** from an accidentally **non sterile pipette**

### 0.1 - 10 µl tip

Natural colour universal crystal tip, graduated. Gilson® type.  
Rack made of **autoclavable** polypropylene up to **121 °C**.

**Recommended for use with:**

Gilson®, Eppendorf®, Biohit®, Dsg®, Elkay®, Finnpiquette®, Genex®, Jencons®, Nichiryo®, HTL® and Handrop®.



code	description	sterile	case quantity	case weight	case volume
● 200024	tips in bulk	no	20 x 1,000	3.80	0.026
● 199084RC	96 tips rack	no	10 x 96	1.92	0.009
● 326-19	filter tips in bulk	no	20 x 1,000	3.70	0.026
● ● ● 327-19	96 tips rack filter	<b>STERILE R</b>	10 x 96	1.26	0.010

Code 326-19 minimum unit sale: 1 bag..



### 0.1 - 10 µl tip

Natural colour universal crystal tip, graduated. Gilson® type.  
Long shape, perfect to pipette samples in deep vessels.  
Rack made of **autoclavable** polypropylene up to **121 °C**.

**Recommended for use with:**

Gilson®, Socorex®, Eppendorf®, Biohit®, Nichiryo®, Finnpiquette®, Dsg®, Elkay®, Genex®, Jencons®, HTL® and Handrop®.



code	description	sterile	case quantity	case weight	case volume
● 301-01	tips in bulk	no	15 x 1,000	3.00	0.026
● 301-01R	96 tips rack	no	10 x 96	1.80	0.010
● 301-01F	filter tips in bulk	no	15 x 1,000	2.92	0.023
● ● ● 301-01FR	96 tips rack filter	<b>STERILE R</b>	10 x 96	1.25	0.012

Tips in bulk: minimum unit sale: 1 bag.

Code 301-01F suitable for Eppendorf® Research Plus.



### 0.5 - 20 µl tip

Natural colour universal crystal tip, bevelled. Eppendorf® type.  
Rack made of **autoclavable** polypropylene up to **121 °C**.

**Recommended for use with:**

Eppendorf®, Gilson®, Biohit®, Brand®, Dsg®, Elkay®, Finnpiquette®, Jencons®, Nichiryo®, Socorex®, HTL® and Handrop® monocanal.



code	description	sterile	case quantity	case weight	case volume
● 301-11	tips in bulk	no	25 x 1,000	4.80	0.050
● 301-10	96 tips rack	no	10 x 96	1.82	0.009
● ● ● 301-09	96 tips rack	<b>STERILE R</b>	10 x 96	1.80	0.009
● 326-37	filter tips in bulk	no	25 x 1,000	5.40	0.035
● ● ● 327-37R	96 tips rack filter	<b>STERILE R</b>	10 x 96	1.25	0.010

Tips in bulk: minimum unit sale: 1 bag.

Colour codes:

- RNase and DNase free
- Metal free
- Pyrogen free



LIQUID HANDLING



## 2 - 20 µl tip

Natural colour universal tip. Eppendorf® type.

Available without filter (2-200µl).

See our codes **200072**.

Rack made of **autoclavable** polypropylene up to **121 °C**.

### Recommended for use with:

Eppendorf®, Biohit®, Finnpiette®, Gilson®, Socorex®, Brand®, HTL®.



code	description	sterile	case quantity	case weight	case volume
● ● ● 200010FR	96 tips rack filter	STERILE R	10 x 96	2.00	0.010

## 2 - 30 µl tip

Natural colour universal filter tip, bevelled.

Gilson® type. Identical code 200078.

Rack made of **autoclavable** polypropylene up to **121 °C**.

### Recommended for use with:

Gilson® P20 P100 P200, Eppendorf®, Biohit®, Dsg®, Elkay®, Finnpiette®, Genex®, Jencons®, Socorex®, Nichiryo®, HTL®, etc.



code	description	sterile	case quantity	case weight	case volume
● 327-36	filter tips in bulk	no	25 x 1,000	9.50	0.071
● ● ● 327-36R	96 tips rack filter	STERILE R	10 x 96	1.59	0.009

Tips in bulk: minimum unit sale: 1 bag.

## 2 - 100 µl tip

Natural colour universal filter tip, bevelled.

Gilson® type. Identical to code 200078.

Rack made of **autoclavable** polypropylene up to **121 °C**.

### Recommended for use with:

Gilson® P100 P200, Eppendorf®, Biohit®, Dsg®, Elkay®, Finnpiette®, Genex®, Jencons®, Nichiryo®, HTL®, etc



code	description	sterile	case quantity	case weight	case volume
● 327-23	filter tips in bulk	no	25 x 1,000	9.00	0.071
● ● ● 327-24	96 tips rack filter	STERILE R	10 x 96	1.96	0.010

Tips in bulk: minimum unit sale: 1 bag.

Colour codes:

● RNase and DNase free    ● Metal free    ● Pyrogen free



LIQUID HANDLING



## 2 - 200 µl tip

Natural colour universal tip, bevelled. Gilson type®.  
Rack made of **autoclavable** polypropylene up to **121 °C**.

### Recommended for use with:

Gilson® P20 P100 P200, Eppendorf®, Biohit®, Dsg®, Elkay®, Finnpiquette®, Genex®, Jencons®, Socorex®, Nichiryo®, HTL®, etc.



code	description	sterile	case quantity	case weight	case volume
● 200078	tips in bulk	no	25 x 1,000	9.20	0.071
● 199078RC	96 tips rack	no	10 x 96	1.96	0.009
● ● ● 199078N	96 tips rack	<b>STERILE R</b>	10 x 96	1.96	0.009

Tips in bulk: minimum unit sale: 1 bag.



## 5 to 100/200 µl tip

Natural colour universal tip. Eppendorf® type.  
Rack made of **autoclavable** (up to 121 °C) polypropylene.

### Recommended for use with:

Eppendorf®, Gilson®, Brand®, Biohit®, Dsg®, Elkay®, Finnpiquette®, Genex®, Jencons®, Kartell®, Nichiryo®, Socorex®, HTL® and Handrop®.



code	description	sterile	case quantity	case weight	case volume
● 327-33	tips in bulk	no	25 x 1,000	10.00	0.071
● ● ● 327-33R	96 tips rack filter	<b>STERILE R</b>	10 x 96	1.97	0.010

### 5 - 100 µl filter tip

### 5 - 200 µl tip

● 200072	tips in bulk	no	25 x 1,000	9.10	0.071
● 199014RC	96 tips rack	no	10 x 96	1.93	0.010
● ● ● 199014N	96 tips rack	<b>STERILE R</b>	10 x 96	1.97	0.010

Tips in bulk: minimum unit sale: 1 bag.



## 2 - 200 µl tip

Universal tip, bevelled. Gilson® type. Tips with filter: natural colour. Tips without filter: yellow colour. Rack made of **autoclavable** (up to **121 °C**) polypropylene.

### Recommended for use with:

Gilson® (except Multichannel), Eppendorf®, Dsg®, Elkay®, Finnpiquette® (except Multichannel), Genex®, Jencons®, Nichiryo®, HTL®, Socorex® serie Akura.



code	description	sterile	case quantity	case weight	case volume
● 327-34	filter tips in bulk	no	25 x 1,000	9.20	0.083
● ● ● 327-34R	96 tips rack filter	<b>STERILE R</b>	10 x 96	1.45	0.010

### Natural colour:

● 200016	tips in bulk	no	25 x 1,000	8.81	0.072
● 200016B	single tips individually wrapped	<b>STERILE R</b>	200	0.19	0.002
● 200016R	96 tips rack	no	10 x 96	1.94	0.009
● 200016REF	96 tips rack	no	5 x 96	0.50	0.006

Code 327-34 minimum unit sale: 1 bag.



Colour codes:

● RNase and DNase free ● Metal free ● Pyrogen free





## 0.1 - 200 µl tip

Universal natural colour tip with collar for gel.  
Translucent rack made of **autoclavable** polypropylene with hinged lid.

### Recommended for use with:

Pipetman®, Eppendorf®, Titertek®, Biohit®, Socorex®, Nichiryo®, Costar Corning®, Oxford®, Rainin®, Finnpiette®.



code	description	sterile	case quantity	case weight	case volume
● 200079	tips in bulk	no	10 x 1,000	9.20	0.050
● ● ● 200079R	96 tips rack	STERILE R	10 x 96	1.20	0.010
● ● ● 200079FS	96 tips rack filter 0.1-100 µl	STERILE R	10 x 96	1.80	0.010

Tips in bulk: minimum unit sale: 1 bag.

## 1 - 200 µl tip

Universal natural colour tip with 91 mm length.  
Rack made of polypropylene **autoclavable** up to **121 °C**.  
Transparent lid and blue base, with 204 tips in 12 x 17 distribution.

### Recommended for use with:

Pipetman®, Eppendorf®, Nichiryo®, Costar Corning®, Oxford®, Volac®, Socorex®, Titertek®, SMI®, Rainin®, Finnpiette®, etc.



code	description	sterile	case quantity	case weight	case volume
● 200026	tips in bulk	no	5 x 1,000	3.50	0.050
● ● ● 200076RF	204 tips rack filter	STERILE R	8 x 204	2.23	0.014

Tips in bulk: minimum unit sale: 1 bag.

Colour codes:

● RNase and DNase free    ● Metal free    ● Pyrogen free

## 1 - 200 µl tip

Natural colour universal tip. Designed to work with viscous fluids like glycerol or thick tissue homogenates. Suitable also for fragile cellular structures, minimizing the risk of tearing or rupture.

### Recommended for use with:

Eppendorf®, Socorex®, Nichiryo®, Finnpiquette®, Biohit®, Oxford®, Pipetman®, Rainin®, Costar Corning®, Volac®.



code	description	sterile	case quantity	case weight	case volume
● 327-40	tips in bulk	no	10 x 1,000	4.20	0.020

Minimum unit sale: 1 bag.



## 5 - 200 µl tip

Eppendorf® universal tip.

Rack made of **autoclavable** polypropylene up to **121 °C**.

### Suitable (not exclusive)

Eppendorf®, Gilson®, Brand®, Biohit®, Dsg®, Elkay®, Finnpiquette®, Genex®, Jencons®, Nichiryo®, Socorex®, HTL® and Handrop®.



code	description	sterile	case quantity	case weight	case volume
● 200009	tips in bulk	no	25 x 1,000	8.75	0.072
● 200009B	single tips individually wrapped	STERILE R	200	0.19	0.002
● 200009R	96 tips rack	no	10 x 96	1.98	0.009
● 200009REF	96 tips rack	no	5 x 96	0.50	0.006



## 5 - 200 µl tip

Yellow universal tip, Gilson® type.

### Recommended for use with:

Gilson®, Eppendorf®, Biohit®, Dsg®, Elkay®, Finnpiquette®, Genex®, Jencons®, Nichiryo®, HTL® and Handrop®.



code	description	sterile	case quantity	case weight	case volume
● 199083	tips in bulk	no	25 x 1,000	9.00	0.071

Minimum unit sale: 1 bag.



LIQUID HANDLING

Colour codes:

- RNase and DNase free
- Metal free
- Pyrogen free





## 2 - 300 µl tip

Natural colour universal tip. Biohit® type.  
Rack made of **autoclavable** polypropylene up to **121 °C**.

### Recommended for use with:

Gilson® P200, Finnpiquette® (old model), Labystems®, Nichiryo® and Handrop®.



	code	description	sterile	case quantity	case weight	case volume
●	200074	tips in bulk	no	24 x 1,000	8.30	0.067
●	199076RC	96 tips rack	no	10 x 96	1.82	0.010

Tips in bulk: minimum unit sale: 1 bag.

## 2 - 200 µl tip

Yellow universal tip with crown and with a 50 µl margin to prevent any accidental overaspiration. Translucent rack made of **autoclavable** polypropylene up to **121 °C**; with hinged lid.

### Recommended for use with:

Eppendorf®, Socorex®, Gilson® except NEO model, Nichiryo®, Biohit®, Brand®, Jencons®, Thermo®, DSG®, Elkay®, HTL®, Finnpiquette®, Genex®.



	code	description	sterile	case quantity	case weight	case volume
●	200076	tips in bulk	no	24 x 1,000	8.82	0.071
●	200076R	tips in bulk	no	10 x 96	1.98	0.010
● ● ●	200076RF	filter tips in rack	<b>STERILE R</b>	10 x 96	2.04	0.010

Tips in bulk: minimum unit sale: 1 bag.

## 5 - 200 µl tip

Natural colour universal tip, bevelled. MLA® type.  
Translucent rack made of **autoclavable** polypropylene up to **121 °C**; with hinged lid.



	code	description	sterile	case quantity	case weight	case volume
●	200017	tips in bulk	no	25 x 1,000	10.50	0.071

Tips in bulk: minimum unit sale: 1 bag.

Colour codes:

● RNAse and DNAse free    ● Metal free    ● Pyrogen free



LIQUID HANDLING



## 5 - 200 µl tip

Natural colour universal tip, bevelled. Oxford® type.  
Suitable for the DiaMed-Micro typing System machine.  
Translucent rack made of **autoclavable** polypropylene up to **121 °C**; with hinged lid.



code	description	sterile	case quantity	case weight	case volume
● 200019	tips in bulk	no	12 x 1,000	6.90	0.071

Tips in bulk: minimum unit sale: 1 bag.



## 20 - 300 µl tip

Natural colour universal tip. Eppendorf® type.  
Rack made of **autoclavable** (up to **121 °C**) polypropylene.  
**Recommended for use with:** Eppendorf®, Gilson®, Brand®, Biohit®, Elkay®, Jencons®, Finnpiquette®, Nichiryo®, Socorex® and Handrop® single channel.



code	description	sterile	case quantity	case weight	case volume
● 200077	tips in bulk	no	20 x 1,000	9.70	0.071
● 200077R	96 tips rack	no	10 x 96	1.94	0.009
● 200077F	filter tips in bulk	no	20 x 1,000	9.90	0.071
● ● ● 200077FR	96 tips rack filter	<b>STERILE R</b>	10 x 96	1.92	0.009

Tips in bulk: minimum unit sale: 1 bag.



## 50 - 1,000 µl tip

Universal tip with collar. Blue or natural colour. Rack made of polypropylene, **autoclavable** up to **121 °C**.

**Recommended for use with:** Eppendorf®, Gilson®, DSG®, Elkay®, Finnpiquette®, Genex®, Jencons®, Nichiryo®. Suitable for Menarini®.



code	description	sterile	case quantity	case weight	case volume
<b>Blue colour:</b>					
● 200012	tips in bulk	no	10 x 1,000	7.95	0.085
● 200012B	single tips individually wrapped	<b>STERILE R</b>	175	0.27	0.004
● 200012R	96 tips rack	no	10 x 96	2.36	0.010
● 200012REF	refill for 96 tips rack	no	5 x 96	0.50	0.060
<b>Natural colour:</b>					
● 200070	tips in bulk	no	10 x 1,000	8.00	0.083
● 200070R	96 tips rack	no	10 x 96	2.40	0.009
● ● ● 200070NR	96 tips rack	<b>STERILE R</b>	10 x 96	2.38	0.010
● 327-30	filter tips in bulk	no	10 x 1,000	8.50	0.083
● ● ● 327-30R	96 tips rack filter	<b>STERILE R</b>	10 x 96	1.99	0.010

Codes 200070, 200012 and 327-30 minimum unit sale: 1 bag.

Colour codes:

- RNAse and DNase free
- Metal free
- Pyrogen free





### 50 - 1,250 µl tip

(50-1,250 µl filter tips).  
Natural colour universal tip.  
Rack made of polypropylene, **autoclavable** up to **121 °C**.

**Recommended for use with:** Socorex®, Gilson®, Nichiryo®, Brand®, HTL®, Biohit®, Eppendorf® Research, DSG®, Elkay®, Finnpiquette®, Handrop®.



code	description	sterile	case quantity	case weight	case volume
● 200071	tips in bulk	no	10 x 1,000	8.50	0.083
● ● ● 200071NR	96 tips rack	<b>STERILE R</b>	10 x 96	2.50	0.010
● ● ● 327-31R	96 tips rack filter	<b>STERILE R</b>	10 x 96	2.80	0.010

Tips in bulk: minimum unit sale: 1 bag.

### 100 - 1,000 µl tip

Gilson® Universal tip. Rack made of polypropylene, **autoclavable** up to **121 °C**.  
**Recommended for use with:** Gilson®, Eppendorf®, Biohit®, DSG®, Elkay®, Finnpiquette®, Genex®, Jencons®, Nichiryo®, Socorex®, HTL® and Handrop®.



code	description	sterile	case quantity	case weight	case volume
<b>Blue colour:</b>					
● 200080.1	tips in bulk	no	10 x 1,000	9.96	0.085
● 200080.1R	96 tips rack	no	10 x 96	2.62	0.015
<b>Natural colour:</b>					
● 200082	tips in bulk	no	10 x 1,000	10.80	0.083
● 200082R	96 tips rack	no	10 x 96	2.66	0.015
● ● ● 200082NR	96 tips rack	<b>STERILE R</b>	10 x 96	2.62	0.013
● 200082F	filter tips in bulk	no	10 x 1,000	11.20	0.083
● ● ● 327-16	96 tips rack filter	<b>STERILE R</b>	10 x 96	2.19	0.013

Tips in bulk: minimum unit sale: 1 bag.

### 100 - 1,000 µl tip

Universal tip with collar. Natural colour, Eppendorf® type. Translucent rack made of **autoclavable** polypropylene up to **121 °C**; with hinged lid.

**Recommended for use with:** Eppendorf®, Nichiryo®, Biohit®, Brand®, Dsg®, Gilson®, Elkay®, Finnpiquette®, Genex®, Jencons®, HTL® and Handrop®. Suitable for Menarini®.



code	description	sterile	case quantity	case weight	case volume
● 200029	tips in bulk	no	10 x 1,000	8.10	0.083
● 200029R	96 tips rack	no	10 x 96	2.40	0.010
● 200029F	filter tips in bulk	no	10 x 1,000	8.10	0.083
● ● ● 200029RF	96 tips rack filter	<b>STERILE R</b>	10 x 96	2.40	0.013

Tips in bulk: minimum unit sale: 1 bag.

Colour codes:

● RNase and DNase free      ● Metal free      ● Pyrogen free



LIQUID HANDLING



### 5 - 1,000 µl tip

Universal natural colour tip. Beckmann® type.

**Recommended for use with:** Sherwood®, Lancer®.

code	description	sterile	case quantity	case weight	case volume
● 200021	tips in bulk	no	10 x 1,000	6.90	0.071

Minimum unit sale: 1 bag.

### 100 - 1,000 µl tip

Universal tip. Oxford® type.

**Recommended for use with:** Finnpiquette®, Labssystem®

code	description	sterile	case quantity	case weight	case volume
● 200020	tips in bulk	no	8 x 1,000	10.40	0.071

Minimum unit sale: 1 bag.

### 200 - 1,000 µl tip

Natural colour universal tip special for MLA®. Bevelled.

**Recommended for use with:** Finnpiquette® colour.

code	description	sterile	case quantity	case weight	case volume
● 200018	tips in bulk	no	8 x 1,000	2.75	0.071

Minimum unit sale: 1 bag.

Colour codes:

- RNase and DNase free
- Metal free
- Pyrogen free





### 1 - 5 ml macrotip

Natural colour universal macro tip, with collar. Eppendorf® type.  
Rack made of polypropylene **autoclavable** up to **121 °C**. Polycarbonate transparent lid and marble base.  
Sliding lid.

**Recommended for use with:** Biohit®, Dsg®, Eppendorf®, Genex®, Jencons®, Socorex® Acura 835.



code	description	sterile	case quantity	case weight	case volume
● 200075	tips in bulk	no	8 x 250	5.90	0.088
● 199075	50 tips rack	no	4 x 50	1.98	0.015
● ● ● 200075RF	50 tips rack filter	<b>STERILE R</b>	4 x 50	2.50	0.015



### 1 - 5 ml macrotip

Natural colour universal macro tip with collar. Finnipipette® type.  
Rack made of polypropylene **autoclavable** up to **121 °C**.  
Transparent lid and marble base. Sliding lid.

**Recommended for use with:** Brand®, Labsystem®.



code	description	sterile	case quantity	case weight	case volume
● 200028	tips in bulk	no	8 x 250	6.76	0.085
● 200028R	50 tips rack	no	4 x 50	2.20	0.015
● ● ● 200028RF	50 tips rack filter	<b>STERILE R</b>	4 x 50	2.50	0.015

Colour codes:

● RNase and DNase free      ● Metal free      ● Pyrogen free



## 2 - 10 ml macrotip

Macro tip for Eppendorf®, Biohit® and Gilson® electronic pipettes.

**Recommended for use with:** Gilson Electronic 10000®, Biohit® electronic.



code	description	sterile	case quantity	case weight	case volume
● <b>200014</b>	tips in bulk	no	10 x 100	7.24	0.087
● <b>200014R</b>	25 tips rack	no	4 x 25	2.25	0.015
● ● ● <b>200014FR</b>	25 tips rack filter	<b>STERILE R</b>	4 x 25	2.20	0.015

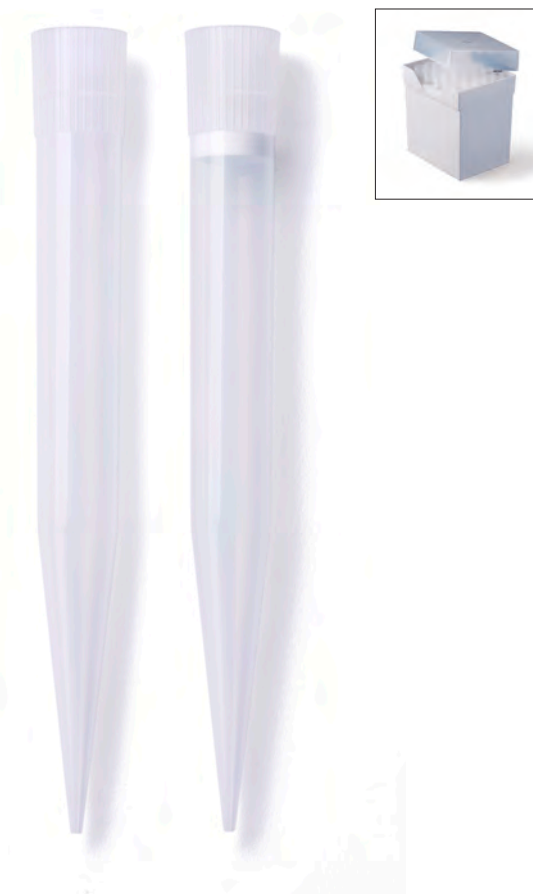

## Rack for refill

Empty racks for the new "refill" format presentation. Achieve significant savings in space and money.

Use one rack and only change the 96-tip refill each time.



code	description	sterile	case quantity	case weight	case volume
<b>BOX-RN300</b>	Empty rack for 300ul refill	no	10	0.014	0.60
<b>BOX-RN1000</b>	Empty rack for 1000ul refill	no	10	0.014	0.74

### Refill tip models:

code	description	case quantity	case weight	case volume
<b>200016REF</b>	2 to 200 µl tip	5 x 96	0.50	0.006
<b>200009REF</b>	5 to 200 µl tip	5 x 96	0.50	0.006
<b>200016REF</b>	50 to 1.000 µl tip	5 x 96	0.50	0.006

Colour codes:

● RNase and DNase free    ● Metal free    ● Pyrogen free



LIQUID HANDLING



## 1 - 5 ml macrotip

Blue colour universal macro tip with collar. Socorex® type.  
Rack made of polypropylene **autoclavable** up to **121 °C**.  
Transparent lid and marble base. Sliding lid.

**Recommended for use with:** Gilson®, Nichiryo®.



code	description	sterile	case quantity	case weight	case volume
● <b>200083</b>	tips in bulk	no	8 x 250	5.78	0.085
● <b>200083R</b>	50 tips rack	no	4 x 50	2.10	0.015

\* Except Nichiryo 3100, 5000 and 5000DG.



## 2 - 10 ml macrotip

Natural colour universal macro tip with collar. Gilson® type.  
Rack made of polypropylene **autoclavable** up to **121 °C**.  
Transparent lid and marble base. Sliding lid.

**Recommended for use with:** Labsystem®, Socorex®, Finpipette®, Nichipet®.



code	description	sterile	case quantity	case weight	case volume
● <b>200015</b>	tips in bulk	no	10 x 100	7.24	0.087
● <b>200015R</b>	25 tips rack	no	4 x 25	2.25	0.015
● ● ● <b>200015RF</b>	25 tips rack filter	<b>STERILE R</b>	4 x 25	2.20	0.015

Colour codes:

● RNAse and DNase free      ● Metal free      ● Pyrogen free



## Robotic and conductive tips for TECAN

Manufactured in clean room class ISO 8.  
Racks and tips in conductive polypropylene.  
**Free of DNase, RNase and endotoxins.**

High precision tips.

The conductivity allows the system to recognize the filling height and guarantees a minimum immersion of the tip in the liquid, to ensure safe pipetting and dispensing.

**Recommended for use with:** Tecan Genesis® and Tecan Evo Freedom®.



code	description	rack colour	tips number	case quantity	case weight	case volume
318006	50 µl conductive tip	●	96	5 x 2	0.80	0.0045
318002	200 µl conductive tip	●	96	5 x 2	0.90	0.0045
318003	1,000 µl conductive tip	●	96	5 x 2	2.00	0.0046

For transparent models, please contact the sales department.



## Robotic Tips for Qiagen (300µl and 1,100µl)

Manufactured in clean room class ISO 8.  
Racks and tips in conductive polypropylene.  
**Free of DNase, RNase and endotoxins.**

High precision tips. The conductivity allows the system to recognize the filling height and guarantees a minimum immersion of the tip in the liquid, to ensure safe pipetting and dispensing.

**Recommended for use with:** BEP 2000®, Biorobot®, Elysis Quattro®, Etimax®, Evolis®, Triturus® and others.



code	description	rack colour	tips number	case quantity	case weight	case volume
318000	robotic tip 300 µl	●	96	5 x 2	1.00	0.004
318001	robotic tip 1,100 µl	●	96	5 x 2	1.80	0.0076



## Robotic Tips for Hamilton (300µl and 1,000µl)

Manufactured in clean room class ISO 8.  
Racks and tips in conductive polypropylene.  
**Free of DNase, RNase and endotoxins.**

High precision tips. The conductivity allows the system to recognize the filling height and guarantees a minimum immersion of the tip in the liquid, to ensure safe pipetting and dispensing.

**Recommended for use with:** Hamilton Microblab Star®, Nimbus® and Vantage®.



code	description	rack colour	tips number	case quantity	case weight	case volume
318009	robotic tip 1,000 µl	○	96	5 x 1	0.9	0.008



LIQUID HANDLING



## Handrop® digital - SC

Variable volume single-channel digital pipettes with digital display.  
Precise volume selector.  
Easy calibration and maintenance by the user.  
Lightweight and ergonomic, with tip ejector.



code	volume range $\mu$ l	increments $\mu$ l	accuracy %	precision %	case weight	case volume
770005P	0.1 - 2.5	0.05	2.5 - 12	2 - 5	0.19	0.001
770000P	0.5 - 10	0.1	1.0 - 2.5	0.8 - 1.5	0.19	0.001
770080P	2 - 20	0.5	0.9 - 3.0	0.4 - 2.0	0.19	0.001
770050P	10 - 100	1	0.8 - 3.0	0.15 - 1.5	0.20	0.001
770070P	20 - 200	1	0.6 - 3.0	0.15 - 1.0	0.19	0.001
770060P	100 - 1,000	5	0.6 - 2.0	0.2 - 0.7	0.20	0.001
770040P	200 - 1,000	5	0.6 - 0.9	0.2 - 0.3	0.19	0.001
770110P	1 - 5 ml	0.05 ml	0.5 - 0.7	0.15 - 0.3	0.21	0.001

## Handrop® digital - MC

8 and 12 channel variable volume digital pipettes with digital display.  
Precise volume selector.  
Easy calibración and maintenance.  
Lightweight and ergonomic design with tip ejector.



code	volume range $\mu$ l	increments $\mu$ l	accuracy %	precision %	case weight	case volume
<b>8 channels</b>						
770210P	0.5 - 10	0.1	1.0 - 4.0	1.5 - 4.0	0.36	0.0015
770220P	5 - 50	0.5	1.0 - 3.0	0.5 - 2.0	0.36	0.0015
770240P	50 - 300	5	0.7 - 1.5	0.25 - 0.8	0.36	0.0015
<b>12 channels</b>						
770320P	5 - 50	0.5	1.0 - 3.0	0.5 - 2.0	0.38	0.0015
770340P	50 - 300	5	0.7 - 1.5	0.25 - 0.8	0.36	0.0015

## Single channel and variable volume NICHIPET PREMIUM pipettes

Single channel and variable volume NICHIPET PREMIUM pipettes. These white or pink pipettes have the same features as NICHIPET EXII, and the following advantages:

Nozzle with a high level of tolerance to abrasion, ceramic piston made of non-corrosive materials, and body made as solvent resistant. 4 position to lock the volume. *HyperBlow* system to improve dispensation efficiency.

Body designed to minimize fatigue and corrosion resistance ejector.

**5-year warranty**



code	volume range	increments $\mu\text{l}$	accuracy %	precision %	case weight	case volume
NPP-2	0.1-2 $\mu\text{l}$	0.002	3-12	1-6	0.23	0.0013
NPP-10	0.5-10 $\mu\text{l}$	0.01	1-4	0.5-3	0.23	0.0013
NPP-20	2-20 $\mu\text{l}$	0.02	1-5	0.4-3	0.23	0.0013
NPP-100	10-100 $\mu\text{l}$	0.1	0.8-2	0.3-1	0.23	0.0013
NPP-200	20-200 $\mu\text{l}$	0.2	0.8-1	0.2-0.5	0.23	0.0013
NPP-1000	100-1,000 $\mu\text{l}$	1	0.7-1	0.2-0.5	0.27	0.0013
NPP-5000	1-5 ml	10	0.6-1	0.2-0.3	0.24	0.0013
NPP-10000	1-10 ml	10	0.4-2	0.2-0.4	0.24	0.0013



## Single variable volume NICHIPET EXII

**1** Fully **autoclavable** and UV rays resistant blue or yellow pipettes. Easy digital volume setting. Ceramic piston for volumes bigger than 200  $\mu\text{l}$ . Easy lock with one hand and thermal insulation of the handle. Easy calibration. PTFE Chamber that maintains its tightness and reproducibility for a long time.

**2** Model **EXII Plus** is specifically designed for using with chemical solvents without any danger of corrosion. A Perfluoro rubber O-ring is installed in **Nichipet EXII Plus**.



code EXII	volume range	increments $\mu\text{l}$	accuracy %	precision %	case weight	case volume
NPX2-2	0.1-2 $\mu\text{l}$	0.002	3-12	1-6	0.22	0.0013
NPX2-10	0.5-10 $\mu\text{l}$	0.01	1-4	0.5-3	0.22	0.0013
NPX2-20	2-20 $\mu\text{l}$	0.02	1-5	0.4-3	0.22	0.0013
NPX2-100	10-100 $\mu\text{l}$	0.1	0.8-2	0.3-1	0.22	0.0013
NPX2-200	20-200 $\mu\text{l}$	0.2	0.8-1	0.2-0.5	0.23	0.0013
NPX2-1000	100-1,000 $\mu\text{l}$	1	0.7-1	0.2-0.5	0.25	0.0013
NPX2-5000	1-5 ml	10	0.6-1	0.2-0.3	0.28	0.0013
NPX2-10ML	1-10 ml	10	0.4-2	0.2-0.4	0.22	0.0013



LIQUID HANDLING



### Circular support to house 6 single-channel pipettes

Made of ABS

**Recommended for use with:**

Nichipet premium LT, Nichipet Premium, Nichipet EX II, Nichipet EX Plus II and Nichiryo Le.

code	case quantity	case weight	case volume
MLTSTD2	1	0.407	0.0057



### Handrop® stand for pipettes

The linear and round stands have been designed to fit perfectly Handrop digital pipettes.

The stands are convenient to hold up 6 pipettes both of single and multi-channel.

**Dimensions:** 287 x 276 x 143 mm.

code	case quantity	case weight	case volume
999802	1	0.40	0.002



### Pipetting reservoir

Reservoir specially designed for use with multichannel pipettes. Made of polystyrene.

 See our plates for liquid handling on chapter **Cell culture. Molecular biology**

code	description	sterile	case quantity	case weight	case volume
M-203	25 ml	no	5 x 10	0.63	0.005
M-212	25 ml	no	100	0.82	0.008
M-213	25 ml	STERILE R	100	1.37	0.050
M-201	100 ml	no	100	1.16	0.0019
M-211	100 ml	STERILE R	100	1.99	0.060



### Double-sided pipetting reservoir

Double-sided reagents reservoir.

By one side is a multichannel reservoir that allows pipetting up to 12 different reagents and by the other side is an only reservoir to use with one reagent type. Easy pour-spouts.

It incorporates a lid.

Made of polypropylene **autoclavable** up to 121 °C.



code	description	case quantity	case weight	case volume
M-205	Double-sided reagents reservoir	25	1.07	0.008

## Graduated pipettes

Made in transparent, inert and low density polyethylene.

**Sterile** models are ethylene oxide sterilized.

Volumetrical tolerance:  $\pm 10\%$ .



mod.	code	presentation	sterile	length mm	Ø stem mm	graduated until ml	total capacity ml	bulb draw ml	stem draw ml	graduations ml	case weight	case volume	pallet quantity
A	200002	10 x 500	no	152	7.1	2	4.8	1.8	3	0.50	7.86	0.099	100
B	200006	10 x 500	no	155	7.9	3	7.5	3.2	4.3	0.50	9.65	0.100	100
B	200006.CC	10 x 500	no	155	7.8	3	7.5	3.2	4.3	0.50	11.50	0.095	100
B	200062.0	10 x 500 bag 20 u.	STERILE EO	160	7.8	3	7.0	3.2	3.8	0.50	12.16	0.130	35
B	200007	10 x 100 individually wrapped peel-pack	STERILE EO	154	7.8	3	7.0	3.2	3.8	0.50	10.10	0.160	27
B	200037	10 x 100 individually wrapped flow-pack	STERILE EO	154	7.8	3	7.0	3.2	3.8	0.50	8.19	0.158	27
C	200003	6 x 500	no	155	4.6	1	5.8	3.4	2.4	0.25	5.10	0.061	90
C	200003.CC	6 x 500	no	150	4.6	1	5.8	3.4	2.4	0.25	5.50	0.077	90
C	200032.0	6 x 500 bag 20 u.	STERILE EO	158	5.0	1	5.0	3.1	1.9	0.25	6.48	0.067	48
C	200004	10 x 100 individually wrapped peel-pack	STERILE EO	154	5.0	1	5.0	3.1	1.9	0.25	9.23	0.165	27
C	200034	10 x 100 individually wrapped flow-pack	STERILE EO	154	5.0	1	5.0	3.1	1.9	0.25	7.07	0.162	27



LIQUID HANDLING

## General purpose pipettes

Pasteur pipettes of **small volume** made from transparent, inert, and non-toxic low-density polyethylene (LDPE). Low adhesion surface. Volumetric tolerance  $\pm 10\%$ .

The **fine-tip models** are excellent for dispensing micro volumes and small drops. They can be frozen in liquid nitrogen.

Fine-tip types:

- Ultracapillary: 210003, 210004, 210023, and 210024
- Fine: 210002 and 210022
- For test kits: 210003, 210023, 210022 (e.g., HIV, pregnancy; serum separation mainly in pediatrics, filling chromatography vials, microvials, microplates, gels in electrophoresis, ELISA, etc.)
- For techniques: 210024 (PCR, ELISA, DNA samples, protein assays, hybridomas, atomic absorption, and all types of additions in microtechniques, electrophoresis, etc.)

Codes 210023, 210022, and 210024 are presented in individual peel-pack packaging sterilized by ethylene oxide. The product code, batch number and expiry date are printed on the paper side of the pack.

Codes 210003, 210002 and 210004 are supplied in non sterile bags.

mod.	code	presentation	sterile	length mm	Ø stem mm	total capacity ml	bulb draw ml	stem draw ml	case weight	case volume
<b>Standard tip pipettes</b>										
1	200121	10 x 1.000	no	67	3.9	1.1	0.5	0.6	4.24	0.051
2	200001	8 x 500	no	87	4.7	1.7	0.9	0.8	3.50	0.038
3	200000	10 x 400	no	150	6.3	8.0	4.6	3.4	8.70	0.096
4	200005	6 x 500	no	155	2.5	4.6	3.3	1.3	4.79	0.060
<b>Fine-tip pipettes</b>										
5	210003	8 x 400	no	104	3.0	1.5	1.0	0.5	2.24	0.022
5	210023	500 individually wrapped peel-pack	STERILE EO	104	3.0	1.5	1.0	0.5	1.38	0.027
6	210002	10 x 500	no	144	5.0	5.0	3.3	1.7	7.30	0.099
6	210022	500 individually wrapped peel-pack	STERILE EO	144	5.0	5.0	3.3	1.7	1.66	0.027
7	210004	8 x 250	no	153	3.0	5.5	3.0	2.5	3.30	0.042
7	210024	500 individually wrapped peel-pack	STERILE EO	153	3.0	5.5	3.0	2.5	1.63	0.028

\* For sterile standard tip models, contact the sales department.

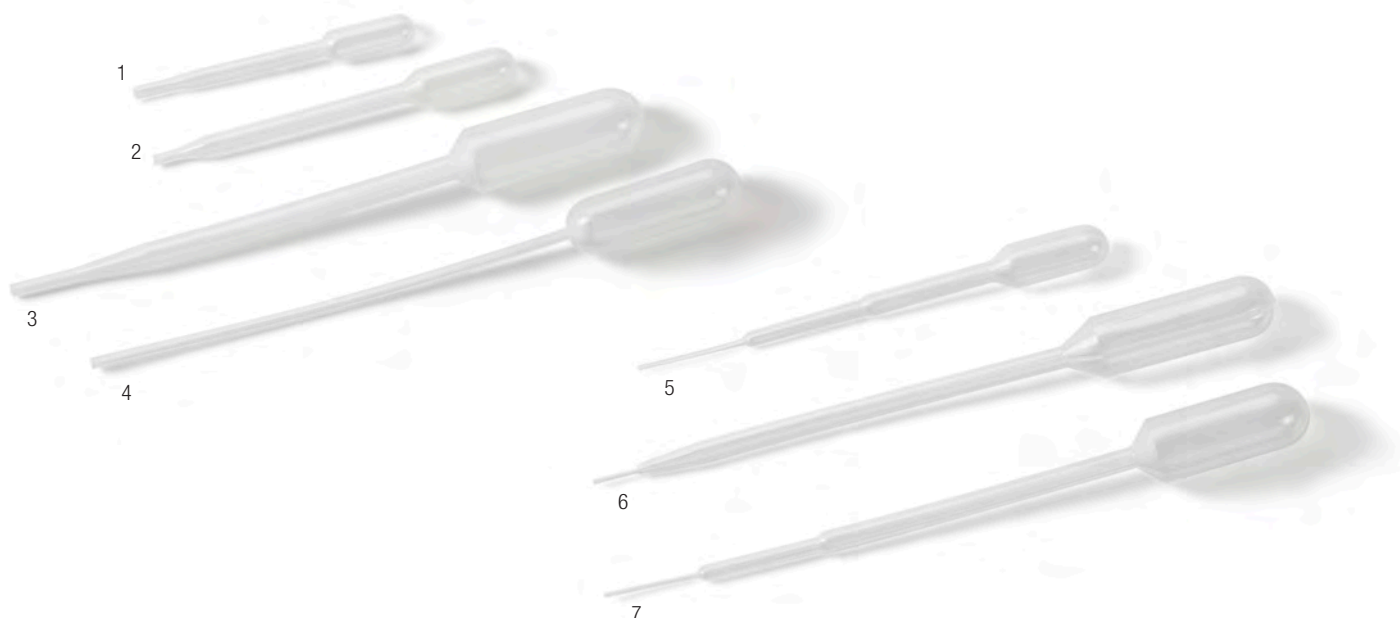

## Extra long pipettes

Made in transparent polyethylene. Model **200050** is graduated each ml up to 5 ml. Volumetrical tolerance:  $\pm 10\%$ .

### Capacity ml:

Total capacity: A = 13.7    B = 23.0    C = 6.0  
 Bulb draw capacity: A = 6.2    B = 7.1    C = 2.3  
 Stem draw capacity: A = 7.5    B = 15.9    C = 3.7

	code	length mm	Ø stem mm	case quantity	case weight	case volume
A	<b>200050</b>	216	-	10 x 250	8.40	0.110
B	<b>200060</b>	300	9,0	10 x 100	7.60	0.110
C	<b>210006</b>	225	5,0	10 x 400	9.04	0.098

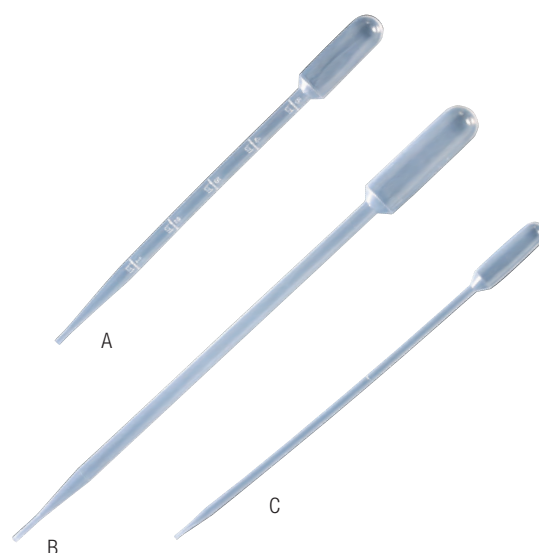

## Micropipettes

Made in transparent, inert and low density polyethylene. They are used as volume measurers, to incorporate in kits of reagents, pregnancy tests, etc. They can be frozen in liquid nitrogen. Before use, press the upper bulb, filling all the stem, and the rest remains in the inferior bulb, which it is not due to be given away. Volumetrical tolerance:  $\pm 10\%$ .

code	length mm	dispense volume µl	case quantity	case weight	case volume
<b>201110</b>	83.0	100	500	0.31	0.003



## Special purpose pipettes

Made in transparent, inert and low density polyethylene. They can be frozen in liquid nitrogen. Volumetrical tolerance:  $\pm 10\%$ .

### Capacity ml:

Total capacity: A = 0,5    B = 1,3  
 Bulb draw capacity: A = 0,2    B = 1,0  
 Stem draw capacity: A = 0,3    B = 0,3

	code	length mm	Ø stem mm	case quantity	case weight	case volume
A	<b>210030</b>	130	3.8	8 x 500	2.90	0.023
B	<b>210005</b>	50	1.19	500	1.90	0.022





### Sterile single use Straw-like pipettes

Single use straw-like non graduated pipettes. In polypropylene. Suitable for automatic pipettes. **Sterilized by radiation.** Packaged in flow packs of 25 units. Outer diameter: 4.35 mm. Inner diameter: 3.65 mm.

code	capacity ml	length mm	case quantity	case weight	case volume
900050	1.0	190	40 x 25	1.19	0.007



### Non graduated serological pipettes. Sterile

Single use, made in polystyrene, without graduation. **In sterile packing by radiation.** **DNase and RNase free**, non cytotoxic, non haemolytic, apyrogen. Without cotton. Suitable for Integra VacuSafe Comfort and others.

**Dimensions:**

External tip diameter, between 5.45 - 5.7 mm, internal diameter tip end: between 1.8 - 2.2 mm.

code	capacity ml	presentacion	case quantity	case weight	case volume
900032.1C	2	1 peel-pack	4 x 500	11.30	0.071



### Glass Pasteur pipettes with open an closed tip

In neutral soda glass, closed at the tip and with cotton in the mouth. The opening of the closed part is simple, by lightly pressing with the fingers.

Open tip measurements:  
 Ø of the mouth:  $6.95 \pm 0.15$  mm  
 Ø tip:  $1.2 \pm 0.15$  mm  
 thickness:  $0.53 \pm 0.03$  mm

Closed tip measurements:  
 Ø of the mouth: 7.0 mm  
 Ø of the tip: 1.4 to 1.6 mm  
 thickness: 0.50 mm

**DGlass** See full DGlass range on pages 272-275

code	total length mm	stem length mm	case quantity	case weight	case volume
<b>Open tips</b>					
701	150	59	4 x 250	3.33	0.012
702	230	130	4 x 250	3.50	0.018
<b>Closed tips</b>					
712	230	130	4 x 250	3.68	0.014

## Sterile serological pipettes

Made of glass polystyrene. Single use only.  
Serological pipettes have an accuracy of +/- 2% at full scale.

### Sterilized by radiation.

Manufactured in one, two or three pieces depending on the volume.

They guarantee maximum precision without liquid retention at the welding level and offer total dispensing. Pyrogenic, non-cytotoxic and non-hemolytic. Volumes from 1 ml to 50 ml, identified with a polyolefin (does not contain synthetic fibers) white cotton and screen printed in colour according to volume. The peel-pack of the models presented in this way is fiber-free and easy to open. Black graduations, bright and unalterable. Negative scale and double inverted scale (ascending and descending graduations).

### DNase and RNase free.

Manufactured in a room with controlled environment, class 100,000.

### BSE / TSE free.

This product does not contain latex.



code	capacity ml	presentation	cotton colour	tip	graduation ml	negative graduation ml	total capacity ml	case quantity	case weight	case volume
900030.C	1	1 peel-pack	●	A	0/0.9	until -0.3	1.3	500	2.59	0.019
900031.C	1	bag of 25	●	A	0/0.9	until -0.3	1.3	40 x 25	4.02	0.019
900130.C	1	1 peel-pack	●	C	0/0.9	until -0.3	1.3	500	2.59	0.019
900032.C	2	1 peel-pack	●	A	0/1.8	until -0.6	2.6	500	3.74	0.019
900033.C	2	bag of 25	●	A	0/1.8	until -0.6	2.6	40 x 25	6.70	0.019
900034.C	5	1 peel-pack	●	A	0/4	until -3	8	200	2.42	0.014
900038.C	5	bag of 25	●	A	0/4	until -3	8	20 x 25	6.38	0.019
900144.C	5	1 peel-pack	●	B	0/4	until -3	8	200	2.42	0.014
900036.C	10	1 peel-pack	●	A	0/9	until -3	13	200	2.73	0.014
900037.C	10	bag of 25	●	A	0/9	until -3	13	16 x 25	5.5	0.019
900136.C	10	1 peel-pack	●	C	0/9	until -3	13	200	2.32	0.013
900146.C	10	1 peel-pack	●	B	0/9	until -3	13	200	3.82	0.014
900041.C	25	1 peel-pack	●	A	0/23	until -8	33	150	3.07	0.019
900043.C	50	1 peel-pack	●	A	0/46	until -10	60	100	2.54	0.019

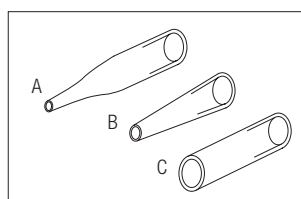

Three models of tips available:  
A = TAPE END,  
B = WIDE TIP,  
C = OPEN TIP  
(recommended for viscose samples).



Find trays, rotary stands and other products for pipettes in chapter **Safety and General Labware**



See our plastic Pasteur pipettes in chapter **Liquid Handling**



Please find racks for these tubes in chapter **Sample Storage**

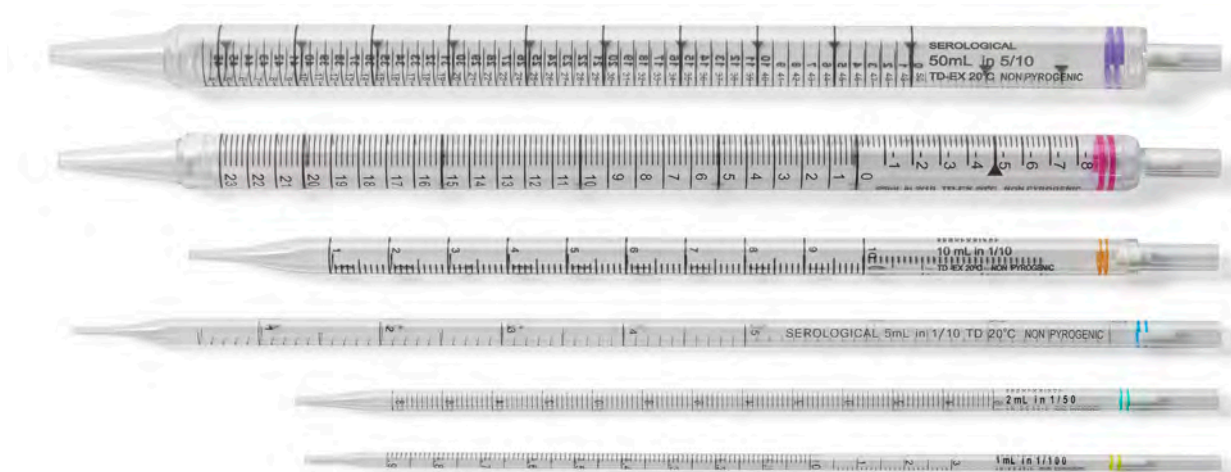





## Pipetting nipple

Designed for pipetting with plastic and glass pipettes.

	code	material	total length mm	Ø max. mm	capacity ml	bag quantity	bag weight	bag volume
1	193914	latex	40	10	3	100	0.22	0.002
2	19195	silicone	40	15	1.5 - 1.8	50	0.22	0.0009

## Pipetting bulb

This one-handed design is the simplest safety pipette filler to use available. Manufactured in natural orange rubber. Approx. drawn capacity: 25 ml. Single hand use, only two operating points. Evacuate via the automatic valve. Standard model, accommodates all pipettes. The inside bulb can be cleaned by removing the patented valve and rinsing out.



1. Evacuate the air by pressing the bulb, as the drawing indicates.



2. Intake by pressing on point B (↑)



3. Drain the liquid by pressing on point A (↓)



4. Blow out the pipette by pressing as the drawing indicates (point C).

code	description	bag quantity	bag weight	bag volume
19200	pipetting bulb	1	0.05	0.0004

## Pipetting bulb

Made of rubber. Used to avoid mouth pipetting and contamination risk. Can be opened, cleaned and **autoclaved**. Ideal for Wintrobe and Westergren pipettes.



code	description	bag quantity	bag weight	bag volume
19201	red pipetting bulb	1	0.04	0.0002

## Pipette trays

Made of white PVC.

Resistant to temperatures from **-20 °C to 80 °C**.

**Model 1**, code **19252**, is perfect to fit inside drawers. It includes four compartments that can hold up to thirty pipettes of 1, 2, 5, or 10 ml.

**Model 2**, code **19996**. Sixteen pipettes up to 10 mm diameter can be accommodated longitudinally; laterally, seven pipettes up to 20 mm diameter. Tray edges are ergonomically designed for a better handling. It is also useful with other instruments.



mod.	code	dimensions mm	case quantity	case weight	case volume
1	<b>19252</b>	426 x 300 x 30	1	0.53	0.006
2	<b>19996</b>	283 x 216 x 40	6	1.38	0.017

## Pipette pumps

Several models for various pipette volumes.

Designed for fast and efficient pipetting with simple, one handed operation.

Pipettes fit smoothly into collar.

Rotate the knurled thumb wheel on the side for precision filling or dispensing, and press the fast release lever for quick emptying.

Easy to use and easily disassembled for cleaning.

Sizes are colour coded. Pipette pumps resist acids and alkalis.

Presentation in individual box.



See our chapter **Sample storage**



code	description	colour	bag quantity	bag weight	bag volume
<b>W-100</b>	up to 2 ml	blue	1	0.06	0.0002
<b>W-110</b>	up to 10 ml	green	1	0.06	0.0002
<b>W-120</b>	up to 25 ml	red	1	0.06	0.0002





# 09. SAMPLE STORAGE





### Polystyrene racks for cryovials

Made of **polystyrene**, those boxes are designed to hold 1 and 2 ml cryovials at temperatures from **-80 °C** to **80 °C**. Stackable.

Boxes with white base and numbered inner rack. Boxes are stackable and have air vents.

Covers are keyed to the base to prevent misalignment.

Each box is supplied with an innovate vial picker for easy vial removal.

**Dimensions:** 133 x 133 x 52 mm.

**Capacity:** 81. **Ø wells:** 12.8 mm.



code	colour	capacity	case quantity	case weight	case volume
M-036B	●	81	4	0.62	0.0045
M-036AM	●	81	4	0.62	0.0045

### Polycarbonate racks for cryovials

These racks provide ultra low temperature storage (from **-196 °C** to **121 °C**), holding 2 or 5 ml cryovials (depending on the model).

Compatible with other storage systems, they can be sterilized using **autoclave** protocols.

They can also be immersed in liquid nitrogen, where its design means minimal issues with excess liquid on their removal.



code	capacity*	model	colour	dimensions mm	diameter mm	max. tubes capacity	max. tubes height	case quantity	case weight	case volume
M-061NA	25	D	●	75 x 75 x 52	14.44	2 ml	48	5	0.35	0.002
M-061AM	25	E	●	75 x 75 x 52	14.44	2 ml	48	20	1.40	0.009
M-062B	81	C	●	132 x 132 x 53	12.7	2 ml	48	5	1.00	0.007
M-062R	81	C	●	132 x 132 x 53	12.7	2 ml	48	5	1.00	0.007
M-063B	81	B	●	132 x 132 x 95	12.7	5 ml	93	5	1.25	0.013
M-063R	81	B	●	132 x 132 x 95	12.7	5 ml	93	5	1.25	0.013
M-064V*	100	A	●	132 x 132 x 53	12.7	2 ml	48	5	0.95	0.007
M-064AM*	100	A	●	132 x 132 x 53	12.7	2 ml	48	5	0.95	0.007

\* The capacity of codes M-064V and M-064AM is halved when used with capped cryovials with external threads.



SAMPLE STORAGE

## Polycarbonate racks for cryovials

Made of extra strong polycarbonate, these boxes are designed to be used at temperatures between **-190 °C** and **121 °C** and are **autoclavable**. Racks can hold either 81 or 100 tubes from 1 ml to 5 ml. They can be immersed in liquid nitrogen. Transparent covers are printed with an alphanumerical grid.

- Boxes made to accept 81 tubes have a white base and a coloured grid (in which each well is numbered) (**A photo**).
- Boxes made to accept 100 tubes\* have a coloured base, with each place numbered in the lid, instead of a grid (**B photo**).
- Each box is supplied with an innovative vial picker for easy vial removal (**C photo**).

Boxes are stackable and have air vents. Covers are keyed to the base to prevent misalignment. The racks have boxes of 12x12 mm.



code	colour	case quantity	case weight	case volume
<b>For 1.2 and 2 ml cryovials. Capacity: 81 wells. Dimensions: 133 x 133 x 52 mm</b>				
M-033AM	●	4	0.73	0.0043
M-033R	●	4	0.73	0.0043
M-033V	●	4	0.73	0.0043
<b>For 3.4 and 5 ml cryovials. Capacity: 81 wells. Dimensions: 133 x 133 x 95 mm</b>				
M-034AM	●	10	2.28	0.0200
<b>For 1.2 and 2 ml cryovials. Capacity: 100 wells. Dimensions: 133 x 133 x 52 mm</b>				
M-035AM	●	4	0.72	0.0043
M-035R	●	4	0.72	0.0043
M-035V	●	4	0.72	0.0043

\* The capacity of codes M-035AM, M-035R and M-035V, is halved when used with capped cryovials with external threads.

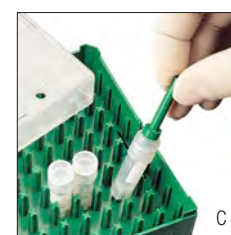



### Rack 9x9 height 45

Polypropylene rack. Dimensions with lid: 133 x 133 x 45 mm. Available in fluorescent colours with transparent lid to help identification.

**It resists -100 °C** and is **autoclavable** up to **121 °C**.

Sections will hold 81 microtubes (0.5, 1.5 or 2 ml) or cryotubes (1.2 ml) up to 12 mm diameter and 42 mm height.

The capacity is reduced when storing external screw cryotubes.

It embodies an alpha numeric grid printed on the base and over the upper rims for a clearer identification of samples.

Suitable for tubes: **200400, 200401, 200405, 200407, 200410, 4092.2N, 4092.5N, 4092.6N, 4092.6NS, 409001.**



code	colour	quantity	weight	volume
M-020AM	●	1	0.17	0.0003
M-020N	○	1	0.17	0.0003
M-020R	●	1	0.17	0.0003
M-020V	●	1	0.17	0.0003



### Rack 9x9 height 50

Polypropylene rack. Dimensions with lid: 133 x 133 x 53 mm.

Available in fluorescent colours with transparent lid to help identification.

**Resists -100° C** and is **autoclavable** up to **121 °C**. Sections will hold 81 microtubes (0.5, 1.5 or 2 ml) or cryotubes (1.2 or 2 ml) up to 12.5 mm diameter and 50 mm height. The capacity is reduced when storing external screw cryotubes. It embodies an alpha numeric grid printed on the base and over the upper rims for a clearer identification of samples.

Suitable for tubes: **200400, 4092.2N, 4092.5N, 4092.6N, 409002, 409002.1, 409110.1, 409111/2.**



code	colour	quantity	weight	volume
U-9950CAM	●	1	0.17	0.0011
U-9950CN	○	1	0.17	0.0011
U-9950CNA	●	1	0.17	0.0011
U-9950CR	●	1	0.17	0.0011
U-9950CV	●	1	0.17	0.0011



### Rack 9x9 height 95

Polypropylene rack. It can be frozen down to **-100 °C**, and **autoclaved** up to **121 °C**.

Dimensions with lid: 133 x 133 x 95 mm. Available in fluorescent colors with translucent-transparent lid.

Ideal for 4 or 5 ml cryotubes. 81 sections will hold microcontainers up to 12 mm diameter and 93 mm high: screw cap microtubes, cryovials (even those of 4 and 5 ml), snap cap microtubes, and short-medium sized tubes.

Suitable for tubes: **300300, 300500, 300700, 300800, 400700, 400800, 401100.**



code	colour	bag quantity	bag weight	bag volume
U-9581N	○	1	0.24	0.0026

Check availability for yellow and green.



SAMPLE STORAGE

### Rack 8x8 round hole height 45

Polypropylene rack, **autoclavable** up to **121 °C**.

**Dimensions with lid:** 133 x 133 x 53 mm.

Available in fluorescent colours with transparent lid to help identification.

**Resists -100° C.**

Sections will hold 64 microtubes (0.5, 1.5 or 2 ml) or cryotubes (1.2 ml) up to 11 mm diameter and 42 mm height.

Alphanumeric identification.

Suitable for tubes: **4092.1N, 4092.1NS, 4092.2N, 4092.5N, 4092.6N, 4092.6NS, 200400, 409111/1.**



code	colour	quantity	weight	volume
U-8845A	●	1	0.13	0.001

Other colors are supplied upon request. Consult the sales department.



### Rack 8x8 round hole height 50

Polypropylene rack, **autoclavable** up to **121 °C**.

**Dimensions with lid:** 133 x 133 x 53 mm.

Available in fluorescent colours with transparent lid to help identification.

**Resists -100° C.**

Sections will hold 64 microtubes (0.5, 1.5 or 2 ml) or cryotubes (1.2 or 2 ml) up to 11 mm diameter and 50 mm height.

Alphanumeric identification.

Suitable for tubes: **200400, 408003, 409110.1, 409110.2, 409110.3, 409110.4, 409110.5, 409111/1, 409111/2, 409111/3, 409111/4, 409111/5, 409111/6, 4092.2N, 4092.5N, 4092.6N, 4092.6NS.**



code	colour	quantity	weight	volume
U-8850A	●	1	0.13	0.0011

Other colors are supplied upon request. Consult the sales department.



### Rack 7x7 height 50

Polypropylene rack, **autoclavable** up to **121 °C**.

**Dimensions with lid:** 133 x 133 x 53 mm.

Available in fluorescent colours with transparent lid to help identification.

**Resists -100° C.**

Sections will hold 49 microtubes (0.5, 1.5 or 2 ml), cryotubes (1.2 or 2 ml), or low volume tubes, up to 16 mm diameter and 50 mm height.

Suitable for tubes: **409002, 409002.1, 409104.1, 409106.1, 409106.2.**



code	colour	quantity	weight	volume
U-7750A	●	1	0.14	0.0012
U-7750N	○	1	0.14	0.0012



SAMPLE STORAGE





## Freezing cardboard storage box, pre-assembled compartments

Designed for storage and preservation of frozen samples.

Made of white treated cardboard and covered by special white paper hand-stuck and hand-assembled for a better quality. Pre-assembled compartments.

**Temperature range between -196°C and 121°C.** There are alphanumeric identifications printed on each box.

The boxes are presented assembled inside.

Adaptable to horizontal freezer racks.



code	external dimensions mm	grid num.	case quantity	case weight	case volume
M-600	150 x 150 x 55	10 x 10	10	2.05	0.017
M-610	150 x 150 x 100	10 x 10	10	2.50	0.030
M-607	134 x 134 x 47	10 x 10	10	1.23	0.013
M-606	134 x 134 x 57	10 x 10	10	1.12	0.021
M-603	134 x 134 x 75	9 x 9	10	1.70	0.021

## Rack 10x10 height 37

Polypropylene rack.

**Dimensions with lid:** 133 x 133 x 37 mm.

Available in fluorescent colours with transparent lid to help identification.

**Resists -196 °C and autoclavable up to 121 °C.**

Sections will hold 100 microtubes up to 10 mm diameter and 34 mm height.



Suitable for tubes: **4092.1N, 4092.1NS, 900117.**



code	colour	quantity	weight	volume
U-0537A	●	1	0.15	0.0012
U-0537N	○	1	0.15	0.0012

## Rack 4x4 height 45

Polypropylene rack.

**Dimensions with lid:** 67 x 67 x 45 mm.

Available in fluorescent colors with transparent lid. It can be frozen up to **-196 °C**, and **autoclaved up to 121 °C.**

16 sections (15x15 mm)

It may be used with taller tubes as the lid lies on their caps (up to 60 mm high).

Suitable for tubes: screw cap microtubes (range **409110.1** for example), cryovials (as code **409001**), snap cap microtubes type Eppendorf® (see codes **200400** or **4092.2N**), and short tubes (codes **300500, 400500, 401100**).



code	colour	bag quantity	bag weight	bag volume
U-4445N	○	5	0.17	0.0013
U-4445A	●	5	0.17	0.0013



## Racks with lid

**Polypropylene** rack, **autoclavable** and designed for storage of samples down to **-90 °C**. The lid is jointed to the rack by hinges. Available in fluorescent colours.

The racks are alphanumericly matrixed and are designed for 1.5 and 2 ml microtubes or 2.0 ml cryotubes; and we can supply two different models which can accommodate 50 and 100 tubes respectively.

**Dimensions:** 71 x 153 x 54 mm (50 wells).  
140 x 153 x 54 mm (100 wells).



code	colour	Ø holes	holes	case quantity	case weight	case volume
M-500	○	12.50 mm	50	20	2.48	0.020
M-501	●	12.50 mm	50	20	2.48	0.020
M-502	●	12.50 mm	50	20	2.48	0.020
M-503	●	12.50 mm	50	20	2.48	0.020
M-510	○	12.45 mm	100	20	3.98	0.028
M-511	●	12.45 mm	100	20	3.98	0.028
M-512	●	12.45 mm	100	20	3.98	0.028
M-513	●	12.45 mm	100	20	3.98	0.028

Minimum order quantity: 5 and multiples of 5 up to 20. From 20, multiples of 20.



## Microtube racks with lift-off telescopic lid

Made of **autoclavable polypropylene**, those racks are designed for long-term storage of samples at temperatures down to **-90 °C**.

Model **M-450** can accommodate 50 microtubes of 0.5 ml (hole diameter 10 mm).

Model **M-410** can accommodate 50 microtubes of 1.5/2.0 ml (hole diameter 12 mm).

Lids have a moulded-in alphanumeric location identification system with a clear centre panel for easy tube viewing. Four frosted side panels and a frosted rim on the edges of the lid provide additional labeling options.



code	dimensions mm	case quantity	case weight	case volume
M-450	120 x 60. height 37.5	5	0.48	0.0022
M-410	140 x 73. height 37.5	5	0.53	0.0035



SAMPLE STORAGE



## Reversible racks with removable handles

Made of polypropylene, **autoclavable** up to **121 °C**.

**Dimensions:** 223 x 67 x 27mm

The racks have two sides for different tubes: one side holds up to 80 tubes of 12 mm diameter (for example 10 x 75 mm or 12 x 75 mm tubes, microtubes, etc.) and the other side holds up to 60 microtubes or PCR tubes (8 mm Ø, 0.2 or 0.5 ml).

By removing the handles, units can be firmly anchored laterally to one another and more units can be added on top of each other, thanks to small pins supplied with the racks.



code	colour	bag quantity	bag weight	bag volume
M-563A	●	10	1.60	0.008
M-563NA	●	10	1.60	0.008

## 80 well racks

Made of **autoclavable polypropylene**, those racks are designed for freezer storage and are rated to **-80 °C**.

Racks are designed to accommodate microtubes of diameter up to 11 mm. They are space-saving, as they feature 80 wells in a 5 x 16 configuration. An alpha-numeric matrix allows accurate sample identification.

Lateral handles allow easy handling of the racks. Racks can be used alone or placed into the box **M-011.1** (made of translucent plastic).

Racks are compatible with the Gilson FC80 dispenser, for example.



code	colour	dimensions mm	case quantity	case weight	case volume
M-010.1	●	225 x 65 x 27	5	0.86	0.0023
M-010.2	○	225 x 65 x 27	5	0.86	0.0023
M-010.5	●	225 x 65 x 27	5	0.86	0.0023
M-010.6	●	225 x 65 x 27	5	0.86	0.0023
M-010.7	●	225 x 65 x 27	5	0.86	0.0023



## Isofreeze Rack with temperature indicator

Manufactured from **polypropylene**, this rack is filled with a non-toxic gel that maintains **4 °C** temperature for almost three hours and a half when the rack is removed from the freezer (or in case of freezer failure), protecting PCR reagents, cells, enzymes, etc. from fast temperature changes.

Moreover, the plastic changes its colour from green to yellow as long as the temperature of the rack changes (see figure). It can hold up to 96 0,2 ml single microtubes, strips, and plates.

**Dimensions with lid:** 141 x 99 x 44 mm.

**Dimensions without lid:** 141 x 99 x 38 mm.

**ATTENTION:** Freeze for a minimum of eight hours at **-20 °C** before use. Keep it covered while being used. Store at the freezer while not being used.



See our PCR tubes and plates in chapter **Cell culture. Molecular biology**



code	Ø holes mm	case quantity	case weight	case volume
M-572	6,78	2	0.64	0.003

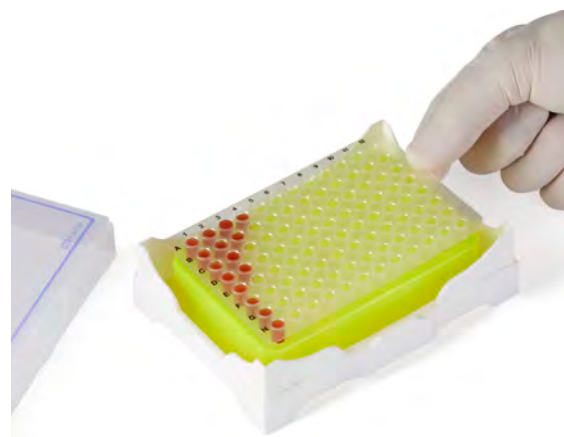
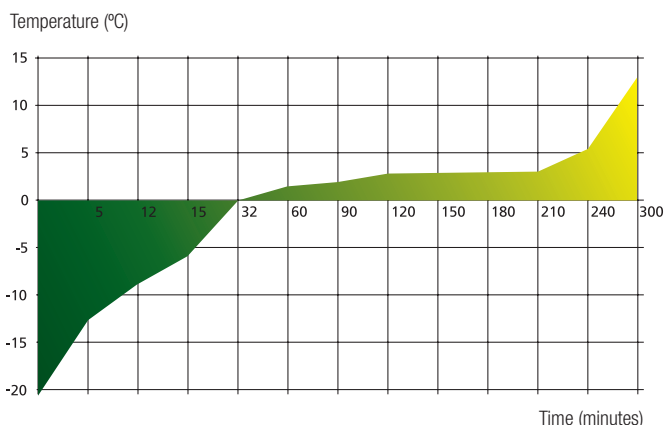

Rack at room temperature



Rack at -20 °C



## PCR racks with lid

Base and cover made of **autoclavable polypropylene**.

Designed for storing and working 0,2 ml PCR tubes, separate or in strips. 96-well plates can also be accommodated. Both base and cover have an alphanumeric identification.

Once covered they are stackable.

Racks can be horizontally attached to each other in order to build-up any configuration.

**Dimensions with cover:** 132 x 91 x 32 mm

It withstands from **-90 °C** to **121 °C**.

The wells are conical with **diameters** of 6mm and 4mm.



code	colour	case quantity	case weight	case volume
M-585	●	20	3.00	0.020
M-581	●	20	3.00	0.020

Minimum order quantity: 5 and multiples of 5 up to 20.



SAMPLE STORAGE



## 24 well incubation rack

Made of **autoclavable polypropylene**.

This floating rack will incubate up to 24 microtubes in a water bath and can accommodate either 0.5 ml or 1.5 ml tubes.

Tubes are held snugly and then released when the rack is pressed down on a benchtop.

The rack is alphanumerically labelled for better sample identification.

**Dimensions:** 119 x 78 mm.



code	description	case quantity	case weight	case volume
M-022	incubation rack	4	0.29	0.0024

## Round incubation racks

Made of **autoclavable polypropylene**, those racks are designed to hold either 8 or 20 microtubes (1.5 ml) in 10.8 mm holes.

Even when the rack is fully loaded, tubes are completely immersed while tops rest above the rack, floating in a beaker of water.

Perfect for use in benchtop incubation.

The rack is easily unloaded by lightly pressing it down against the bench until the legs touch, releasing the tubes.

Racks are 6.4 mm thick with 19 mm long legs and a central handle.



code	capacity	Ø rack	case quantity	case weight	case volume
M-024	8 tubes	66	4	0.13	0.0015
M-026	20 tubes	105	4	0.20	0.0075

## IsoFreeze reversible racks with lid

Manufactured from virtually unbreakable **polycarbonate** and filled with a non-toxic gel, those Isofreeze temperature maintenance racks provide consistent thermal protection for PCR reagents, cells, enzymes or other temperature sensitive agents when removed from the freezer or refrigerator for extended periods of time, and provide safe storage on the event of freezer failure.

Each rack can accommodate up to 20 1.5/2.0 ml microtubes on one side (Ø holes: 12.1 mm), or 20 0.5 ml microtubes (Ø holes: 8.33 mm) on the reverse side.

Racks feature a transparent lid for better sample viewing. Each well in the rack is numbered. Available in two temperature ranges.

Model M-570 (white) will maintain a temperature of 0 °C on the bench top for 5 hours.

Model M-571 (blue) will maintain a temperature between -10 °C and -20 °C on the bench top up to 3 hours.

**Dimensions with lid:** 172 x 180 x 70 mm.



code	colour	case quantity	case weight	case volume
M-570	○	1	1.30	0.005
M-571	●	1	1.30	0.005



## 20 well interlocking tube racks

Made of blue **autoclavable polypropylene**.

These racks slide together on both sides to allow the user to attach several for larger experiments.

They are designed to accommodate 1.5/2.0 ml Eppendorf® type tubes on two levels of 10 wells each of 10 mm Ø, with easy-to-read numbers for better tube viewing and identification.

The innovative front finger slot makes them easy to handle when working with gloves. **Dimensions:** 210 x 90 x 48 mm.



code	colour	case quantity	case weight	case volume
200420	●	6	0.80	0.004



## 50 well microtube racks

Made of **autoclavable polypropylene**, these racks are designed for use with our tubes presented on page 174 and successive. They can hold 50 tubes in a 10 x 5 configuration. These racks allow easy one handed opening and closing of tubes thanks to an innovative locking system which ensures that tubes will securely lock in each well and will not turn. Each place is identified with an alphanumeric index for better sample location. Racks have strong handles for better handling and are stackable.

**Dimensions:** 100 x 250 x 25 mm.

**Diameter:** 12 mm

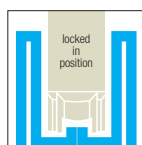

code	colour	case quantity	case weight	case volume
M-028.5	●	4	1.00	0.004
M-028.6	●	4	1.00	0.004



## Styrofoam racks without lid

Racks made of expandable **polystyrene**.

Ideal for long term storage of microtubes in the freezer.

They are stackable, lightweight and economical.

100 wells rack.



code	suitable microtubes	dimensions (mm)	Ø holes	case quantity	case weight	case volume
244109	10 ml	224 x 213 x 48	16 mm	24	1.40	0.069
244111	5 ml	194 x 183 x 43	13 mm	48	1.90	0.094



SAMPLE STORAGE



## PCR workstations

**Autoclavable** manufactured in polypropylene. This storage/working rack, with lid, is designed to work with different PCR volumes at the same time. It can accommodate up to 32 individual 0.2 ml PCR tubes (Ø: 6,35 mm), 16 0.5 ml microtubes (Ø: 8,20 mm) and 24 1.5/2.0 ml (Ø: 11,43 mm). Tube wells are alpha-numerically matrixed with raised bold type for accurate sample identification. The rack also has a transparent lid for easy viewing of samples. Frosted writing panels on four sides allow labelling or writing. The rack is supplied with a removable rack accommodating 0.2 ml PCR tubes. The removable rack can be purchased separately: see product code below.

**Dimensions:** main rack: 215 x 118 x 50 mm.

Removable rack: 125 x 85 x 15 mm.

Both racks withstand from **-90 °C to 121 °C**.



code	colour	case quantity	case weight	case volume
M-540	●	5	1.46	0.007
M-541	●	5	1.46	0.007
M-542	●	5	1.46	0.007

Minimum unit sale: 5

## Racks for 96 PCR tubes with lid

**Autoclavable** polypropylene.

Our 96 well plate, individual tubes or strips of 8 or 12 tubes can be used with this rack. An alphanumeric grid helps sample identification.

The included lid is transparent and has a non-slip surface to allow safe storage of multiple racks.

This rack can be used alone or inserted in the above workstation, code **M-540**.

**Dimensions:** 125 x 85 x 15 mm. It withstands from **-90 °C to 121 °C**.

Ø: 6.10 mm.



code	colour	case quantity	case weight	case volume
M-550	●	5	0.80	0.005
M-551	●	5	0.80	0.005
M-552	●	5	0.80	0.005
M-553	●	5	0.80	0.005

## 5ml microtubes rack

Supports common tube sizes (0.5, 1.5 / 2.0 and 5.0 ml).

Ideal for microtubes and microcentrifuge tubes.

The lateral notches facilitate easy removal of the lid.

Suitable for temperatures as low as -90 °C, as well as autoclaving.

The racks come with a lid.

**Dimensions:** 143.8 x 75.2 x 53.0 mm.



code	colour	case quantity	case weight	case volume
M-015	○	5	2.30	0,013



## Stacking PCR work up rack

**Autoclavable** polypropylene. The stacking PCR work-up rack is a robust and convenient workstation or storage rack for plates, strips or tubes.

**Dimensions with lid:** 98 x 138 x 39 mm.

**Dimensions without lid:** 98 x 138 x 30 mm.

It withstands from **-90 °C to 121 °C**. The conveniently small footprint ensures it is an equally useful tool whether it is used on the bench, in the freezer or some other laboratory situation. The positive click ensures the lid will not become easily dislodged. Yet only a gentle squeeze on each side will allow you to lift off the clear lid. It accommodates every different type of 0,2 ml PCR plate; including fully skirted types, strips or tubes. The imaginative shaping of the rack's feet make this system easy to use, providing a stable platform as well as enabling **stacking with or without the lid** and whether the vessels are open or sealed.

*The racks are manufactured in distinctive colours and are packaged as an assortment.*



code	description	case quantity	case weight	case volume
M-554	stacking PCR rack	5	0.45	0.0035

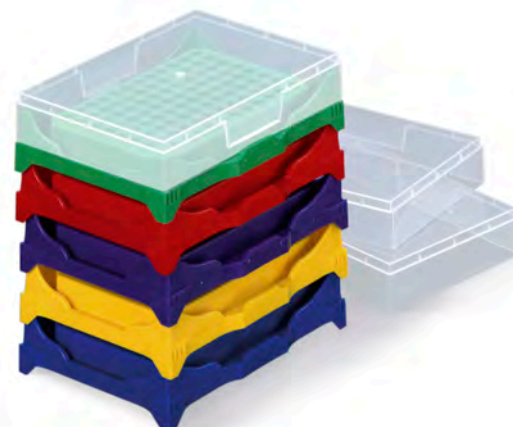

## COMBI Rack for PCR tubes

The box is made of (**non autoclavable**) PVC and the rack is made of **autoclavable** polypropylene. Rack and box can be used both together and separately.

**The box:** can be used not only as a storage rack but also as a work station. The white base accepts both 96 and 384 well plates and a transparent cover.

It is stackable, and its low height helps to save space. Lid dimensions: 108.0 x 148.6 x 35.6 mm. Box dimensions: 108.0 x 148.6 x 24.9 mm.

**The rack:** can hold up to 96 PCR tubes or plates or 12 strips of 8 tubes with caps. Each hole is identified with an alpha numeric numbering system.

It features a writing area. It is stackable.

Can withstand temperatures from **-80 °C to 121 °C**.

**Dimensions:** 84.6 x 125.5 x 28.9 mm.



code	description	case quantity	case weight	case volume
M-640	white box with lid	5	0.20	0.0004
M-641	96 hole blue rack	5	0.20	0.0004



## Reversible 96 well racks with lid

Made of durable **autoclavable** polypropylene. This reversible rack with a clear polypropylene lid is designed with wide spacing to store up to 96 microtubes on either side. One side accommodates 1.5/2.0 ml microtubes; the reverse side accommodates 0.5 ml microtubes. The rack is alphanumericly matrixed for better sample location and has frosted writing patches on all four sides for smear resistant labelling. Operating temperature range: **-90 °C to 121 °C**.

With ergonomical lateral handles.

**Dimensions:** 213x114x26 mm.



code	colour	case quantity	case weight	case volume
M-021AM	●	5	2.05	0.008
M-021R	●	5	2.05	0.008
M-021V	●	5	2.05	0.008



SAMPLE STORAGE





### 42 well cuvette rack

Made of white **autoclavable** polypropylene, this easy to assemble rack provides gentle no-scratch support for fragile spectrophotometer cells. Forty-two 12 mm light path cells fit in this 6 x 7 row layout (See page 93). Also suitable for tubes. Racks are supplied dismantled.

**Dimensions:** 128 x 105 x 43 mm. **Holes:** 12x12mm



code	description	case quantity	case weight	case volume
M-100	well cuvette rack	8	1.04	0.013



### Test tube baskets

For rinsing, transport and storage.

Made of **autoclavable** polypropylene, these baskets with sliding lids are ideal for rinsing or carrying glassware.



code	description	case quantity	case weight	case volume
M-050	basket 152 x 152 x 152 mm	6	1.39	0.003
M-060	basket 229 x 229 x 229 mm	6	3.12	0.080

### Pipette rack

Made of **autoclavable** polypropylene.

For orderly, space-saving pipette storage.

This rack holds 50 pipettes in a vertical 5 x 10 arrangement.

This system ensures that pipettes will not contact table surface.

The end plates have handles for easy carrying.

Hole diameter: 16 mm.

**Dimensions:** 213 x 114 x 222 mm.



code	description	case quantity	case weight	case volume
19973	pipette rack	1	0.54	0.006

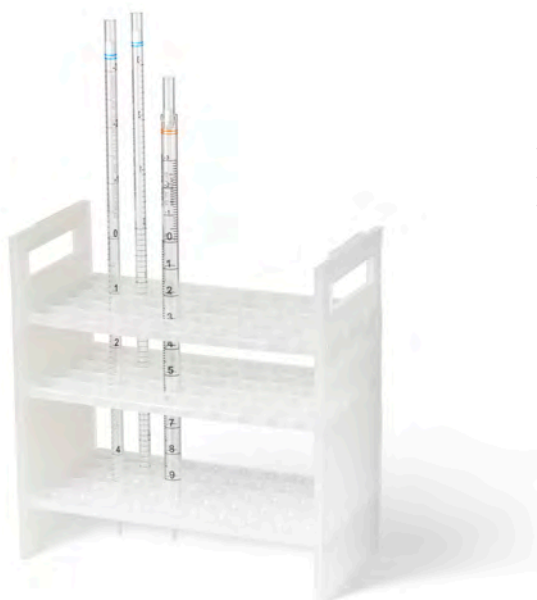

## Universal racks

Made of durable polypropylene, this versatile rack is specially **designed to attach to another by pressing the two sides together**. Two racks or more can then be attached to present tubes in varied configurations.

The rack can accommodate the following:

- 4 x 50 ml conical tubes
- 12 x 15 ml conical tubes
- 32 x Ø12 mm tubes or 1.5/2.0 ml microtubes
- 32 x 0.5 ml microtubes

Alpha-numeric matrix on the four sides for better sample location. Can be autoclaved and can be placed in freezers and water baths.

**Dimensions:** 172 x 50 x 90 mm.



code	colour	case quantity	case weight	case volume
M-520	○	5	0.96	0.005
M-521	●	5	0.96	0.005
M-522	●	5	0.96	0.005
M-523	●	5	0.96	0.005

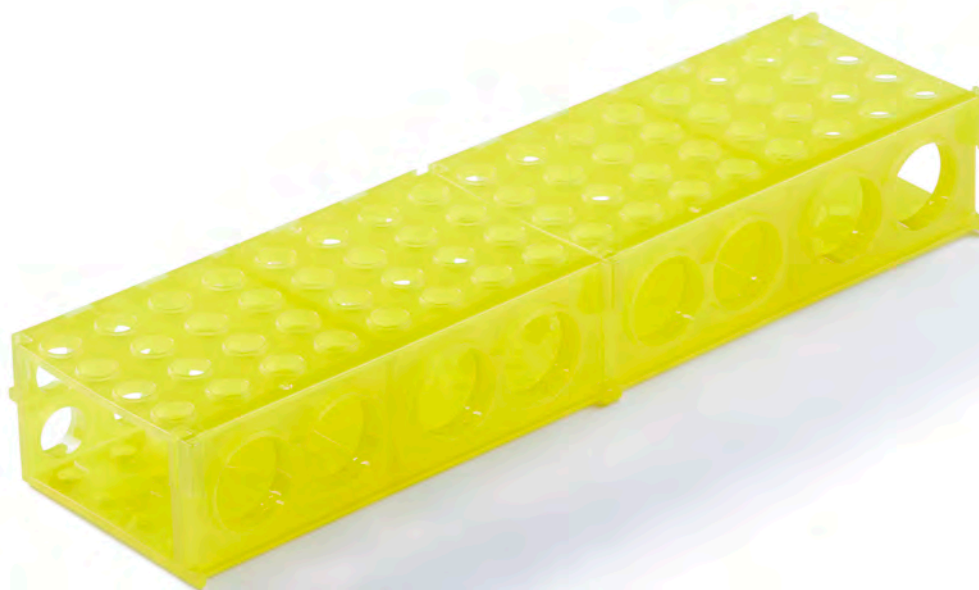

## Set of mixed Combi rack

Made of **autoclavable** polypropylene.

It withstands from **-90 °C to 121 °C**.

This design is made of a unit of four independent cubes packaged in a clear support tray.

Each rack may be independently rotated to allow the simultaneous storage and use of multiple sizes of tubes.

Each side of the racks is alpha-numeric matrixed for better sample location.

The following tubes can be accommodated in each rack:

- 2 x 50 ml conical tubes
- 6 x 15 ml conical tubes
- 9 x 12 mm diameter tubes or 1.5/2.0 ml microtubes
- 12 x 0.5 ml microtubes

### Dimensions:

Tray (handles included): 243 x 102 x 41 mm.

Rack: 48 x 92 x 92 mm.



code	colour	case quantity	case weight	case volume
330	<span style="color: blue;">●</span> <span style="color: yellow;">●</span> <span style="color: red;">●</span> <span style="color: green;">●</span>	1	0.63	0.003

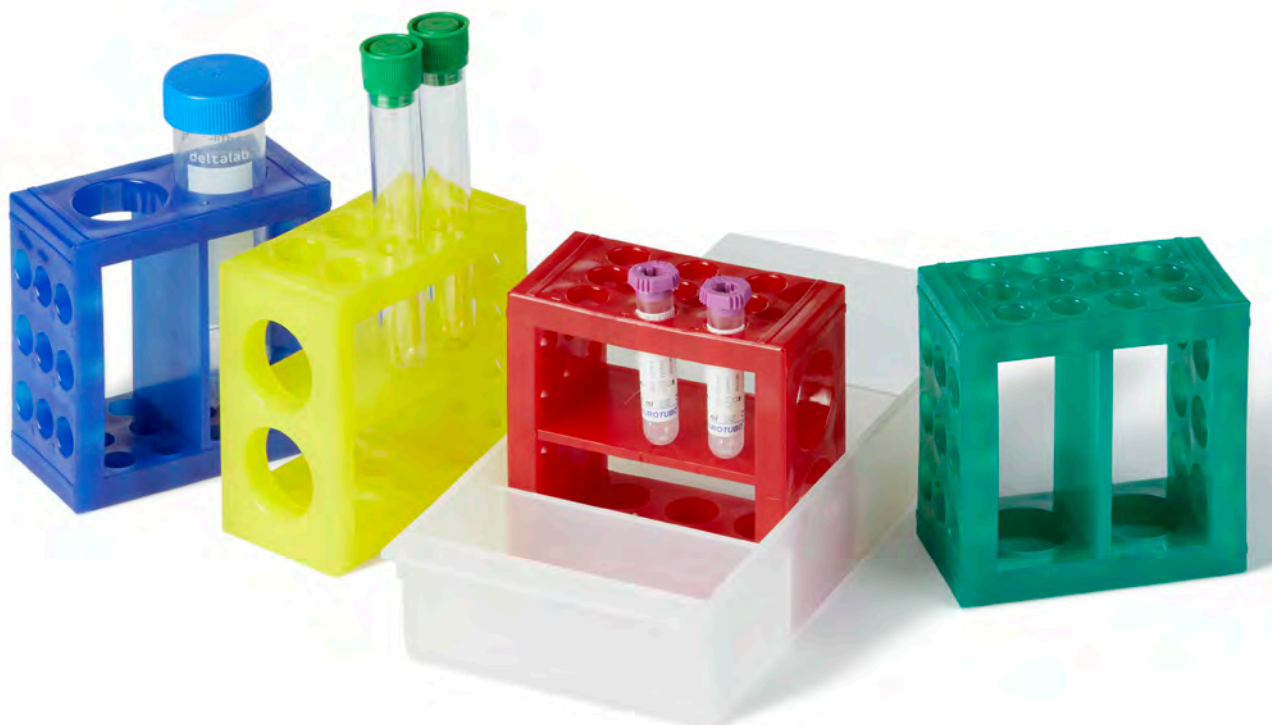

SAMPLE STORAGE

## Universal test tube racks

Made of **autoclavable** polypropylene. Specially designed to ensure that all test tubes will be incubated at the same temperature. An alpha-numeric grid reference the top tier of the rack allows an easy sample location. Racks are easily assembled, and are stackable when unloaded. Each rack is supplied dismantled. Easy to assemble.



code	places	Ø test tube mm	dimensions mm	bag quantity	bag weight	bag volume	blue	yellow	red
							(to add at the end of the code)		
19563	100 (4 x 25)	micro	262 x 108 x 45	5	0.70	0.007	.04	.06	.10
19564	90 (6 x 15)	13	246.5 x 104 x 60	5	0.80	0.006	.04	.06	.10
19565	60 (5 x 12)	16	246.5 x 104 x 70	5	0.89	0.006	.04	.06	.10
19566	40 (4 x 10)	20	246.5 x 104 x 70	5	0.82	0.006	.04	.06	.10
19567	40 (4 x 10)	25	296.5 x 124 x 85	5	1.00	0.007	.04	.06	.10
19568	24 (3 x 8)	30	300 x 111 x 83	5	0.88	0.009	.04	.06	.10



## Assembling rack

This rack is moulded of blue **autoclavable** polypropylene. Suitable for daily usage and storage. It holds up to 21 tubes of 50 ml (30 mm diameter) each, and features end plates for labelling, as well as numbered and lettered rows for tube identification. Interlocking feet allows stacking of racks for storage.

This rack is supplied flat, individually bagged. Fast and easy assembling (instructions included).



code	dimensions mm	rows	case quantity	case weight	case volume
19570	246 x 104 x 64	3 x 7	8	1.50	0.020



SAMPLE STORAGE



### Acetal polymer racks

Made of acetal polymer. **Autoclavable up to 121 °C** for 20 minutes. Stackable. Compact and lightweight. It remains stable if submerged. Colour blue. With handles on each side for better handling.

**External dimensions for all codes:** 293 mm x 115 mm x 65 mm H.

**Recommended for tubes:** 12x75, 13x75, 15x95, 16x100, centrifugation tubes, urine collection tubes, etc.



code	for tubes Ø	capacity	case quantity	case weight	case volume
M-560A	up to 13 mm	(6 x 14) 84	10	3.27	0.032
M-561A	up to 16 mm	(5 x 12) 60	10	3.00	0.029

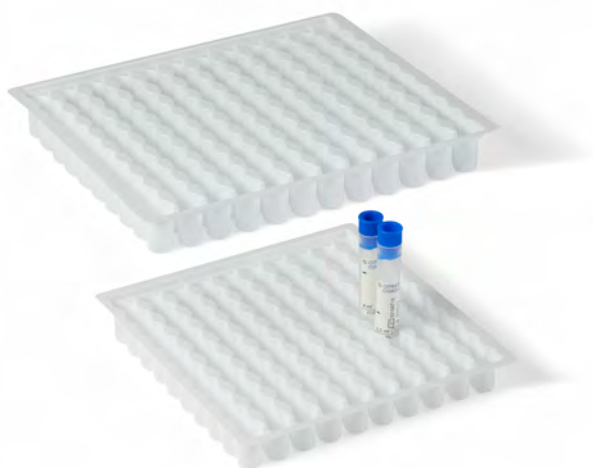

### Single use racks

Low-price, flexible racks made of polystyrene.

Dimensions:

**901407:** 200 x 240 x 30 mm

**901410:** 160 x 170 x 25 mm

code	Ø hole	n° holes	case quantity	case weight	case volume
901407	16 mm	10 x 12	25	1.90	0.033
901410	13 mm	10 x 10	25	0.66	0.012

### Combi rack height 128

Polypropylene rack.

**Dimensions with lid:** 133 x 133 x 128 mm.

Available in fluorescent colours with transparent lid to help identification.

Resist **-196 °C** and autoclavable up to **121 °C**.

Sections will hold 10 tubes up to 30 mm diameter, 2 tubes up to 16 mm Ø and 1 tube up to 11 mm Ø. All of them up to 125 mm height.



code	colour	bag quantity	bag weight	bag volume
U-50128A	●	1	0.20	0.0035
U-50128R	●	1	0.20	0.0035
U-50128V	●	1	0.20	0.0035



SAMPLE STORAGE

### Rack 1x1 height 45

Polypropylene rack.  
 Dimensions with lid: 133 x 133 x 45 mm.  
 Available in fluorescent colours with transparent lid to help identification.  
**Resists -196 °C and autoclavable up to 121 °C.**  
 Only 1 cavity.

Suitable for all kind of tubes and other objects.



code	colour	quantity	weight	volume
U-1145A	●	1	0.10	0.0012
U-1145N	○	1	0.10	0.0012



### Rack 1x1 height 70

Polypropylene rack.  
 Dimensions with lid: 133 x 133 x 70 mm.  
 Available in fluorescent colours with transparent lid to help identification.  
**Resists -196° C and autoclavable up to 121 °C.**

Only one cavity. Suitable for all kind of tubes and other objects.



code	colour	quantity	weight	volume
U-1170A	●	1	0.12	0.0014
U-1170N	○	1	0.12	0.0014



### Rack 9x9 height 70

Polypropylene rack.  
 Dimensions with lid: 133 x 133 x 70 mm.  
 Available in fluorescent colours with transparent lid to help identification.  
**Resists -196 °C and autoclavable up to 121 °C.**  
 Sections will hold 81 tubes up to 12 mm diameter and 67 mm height.

Ideal for our references **300500** and **400500**, etc.



code	colour	quantity	weight	volume
U-9970A	●	1	0.18	0.0014

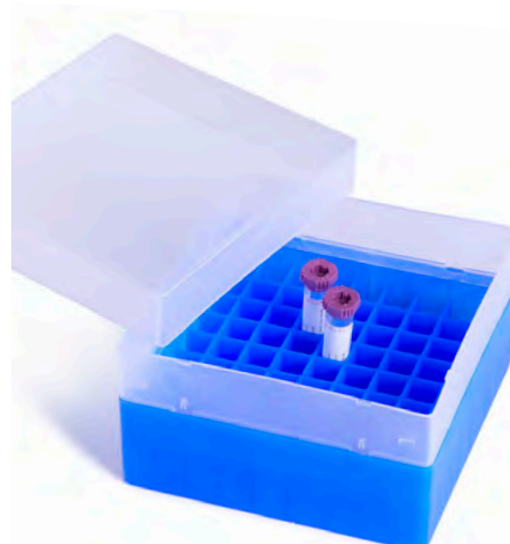

SAMPLE STORAGE



### Rack 7x7 height 80

Polypropylene rack.

**Dimensions with lid:** 133 x 133 x 80 mm.

Available in fluorescent colours with transparent lid to help identification.

Resists **-196 °C** and **autoclavable** up to **121 °C**.

Sections will hold 49 tubes up to 16 mm diameter and 77 mm height.

Suitable for tubes: **401100, 409003.1, 409107.1, 409108.1.**



code	colour	quantity	weight	volume
U-7780A	●	1	0.16	0.0016
U-7780N	○	1	0.16	0.0016
U-7780NA	●	1	0.16	0.0016

### Rack 9x9 height 80

Polypropylene rack.

**Dimensions with lid:** 133 x 133 x 80 mm.

Available in fluorescent colours with transparent lid to help identification.

Resists **-196 °C** and **autoclavable** up to **121 °C**.

Sections will hold 81 tubes up to 12 mm diameter and 77 mm height.

Suitable for tubes: **400500, 409003.2, 409108, 409108.1, 801175T, 901075, 409003.1, 409107, 409107.1, 801075, 801275.**



code	colour	quantity	weight	volume
U-9980A	●	1	0.18	0.0021
U-9980N	○	1	0.18	0.0021

### Rack 7x7 height 96

Made of polypropylene.

**Dimensions with lid:** 130 x 130 x 96 mm

Cryobox for cryogenic tubes without divider, neon green bottom, transparent lid without printing, without ID code.

Suitable for 49 tubes with a diameter of 17 mm.

Storage of materials in refrigerators and freezers up to -100 °C.

**Ideal for tubes 16x90-92 mm or similar tubes.**



code	colour	quantity	weight	volume
U-7796V	●	1	0.17	0.0021



SAMPLE STORAGE

### Rack 9x9 height 96

Polypropylene rack. **Dimensions with lid:** 133 x 133 x 96 mm.  
Available in fluorescent colours with transparent lid to help identification.  
**Resists -196° C and autoclavable** up to 121 C.  
Sections will hold 81 tubes up to 12 mm diameter and 93 mm height.

Suitable for tubes: 300700, 300702, 300704, 300800, 300800.1, 300800.2, 400700, 400800, 400800.1, 409003.1, 409003.2, 409107, 409108, 409107.1, 409109, 409108.1, 409109.1, 801175T, 801275, 901275.



code	colour	quantity	weight	volume
U-9996A	●	1	0.20	0.0021
U-9996N	○	1	0.20	0.0021

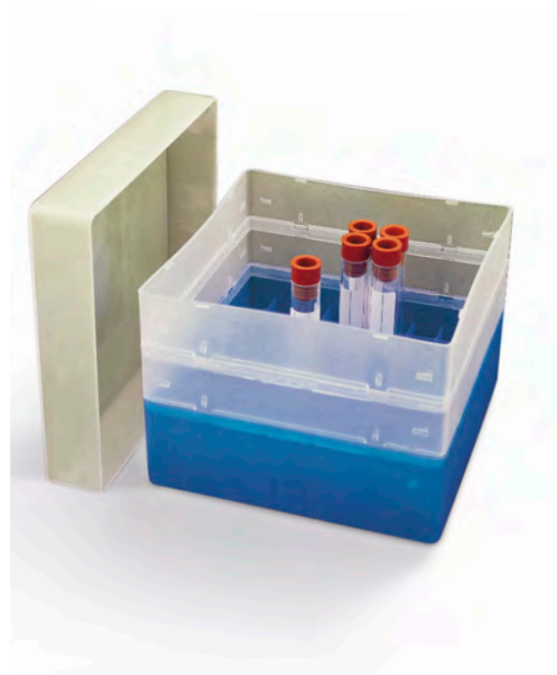

### Rack 5x5 round hole height 105

Polypropylene rack.  
**Dimensions with lid:** 133 x 133 x 105 mm.  
Available in fluorescent colours with transparent lid to help identification.  
**Resists -196° C and autoclavable** up to 121 °C.  
Sections will hold 25 tubes up to 17 mm diameter and 102 mm height.

Suitable for tubes: 300705, 300707, 300900, 301200, 301201, 301202, 301700, 400705, 400900, 401200, 401201, 401204, 401700, 713100, 716100, 810100T, 913100, 916100.



code	colour	quantity	weight	volume
U-105105A	●	1	0.18	0.0023



### Rack 5x5 round hole height 128

Polypropylene rack. **Dimensions with lid:** 133 x 133 x 128 mm.  
Available in fluorescent colours with transparent lid to help identification.  
**Resists -196° C and autoclavable** up to 121 °C.  
Sections will hold 25 tubes up to 17 mm diameter and 125 mm height.  
Alphanumeric codification visible next to the holes.

Suitable for tubes: 300705, 300900, 300904, 300907, 300908, 301200, 301201, 301202, 301212, 301213, 301403, 400705, 400900, 401200, 401201, 401204, 401403, 401700, 409920, 429910, 429940, 429942, 429945, 713100, 716100, 913100, 916100.



code	colour	quantity	weight	volume
U-15128A	●	1	0.20	0.0033
U-15128AM	●	1	0.20	0.0033
U-15128N	○	1	0.20	0.0033



SAMPLE STORAGE



## STAINLESS STEEL RACKS AND BASKETS

For over 40 years we have been producing stainless steel racks and baskets by hand. We use the highest quality materials to obtain excellent racks as a final product, both in terms of finish, strength, robustness and durability. The base of the racks is made of very robust, dense stainless steel mesh.

We can optionally manufacture most models with a side plate for identification.  
For transporting samples we can manufacture them with a safety cover.

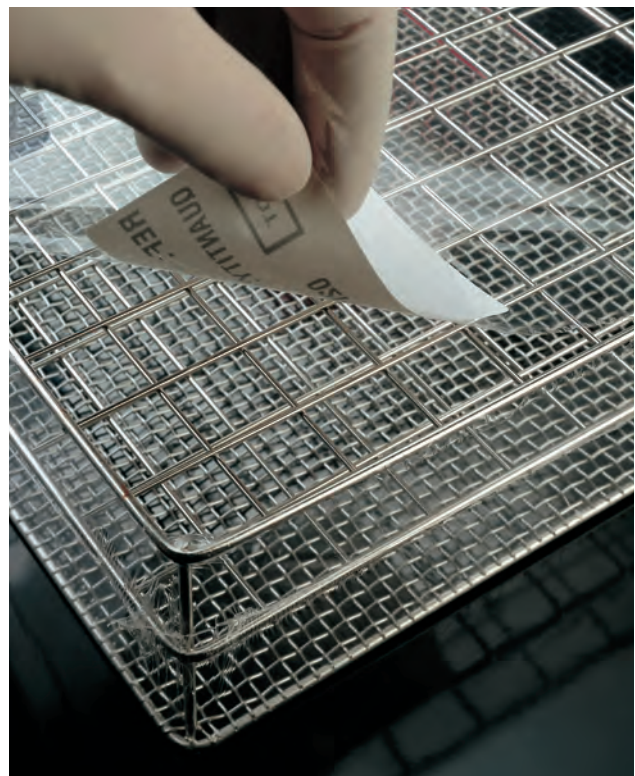

SAMPLE STORAGE

## Aluminum racks

### 10 x 5 holes

Stackable. Alpha-numerical index for better sample location. Supplied encased and interlocked, wrapped in a protecting film.

Code **Z-300** suitable for 12 ml screw tubes, series **301402**, and for 15 ml centrifuge tubes, series **429900** (See chapter of tubes)



code	dimensions mm	Ø hole mm	case quantity	case weight	case volume
Z-100	165 x 85 x 45	12	10	1.26	0.010
Z-250	195 x 100 x 45	15	10	1.63	0.011
Z-300	220 x 110 x 45	17	10	1.86	0.010

### Aluminum racks 5 x 5 holes

Stackable. Alpha-numerical index for better sample location. Supplied encased and interlocked, wrapped in a protecting film. Code **Z-075** suitable for 12 ml screw tubes, series **301402**, and for 15 ml centrifuge tubes, series **429900** (See chapter of tubes).



code	dimensions mm	Ø hole mm	case quantity	case weight	case volume
Z-050	100 x 100 x 45	15	10	0.86	0.010
Z-075	110 x 110 x 45	17	10	1.06	0.010

Minimum unit sale: 1

## Stainless steel racks

### 10 x 5 holes

Stackable. Alpha-numerical index for better sample location. Supplied encased and interlocked, wrapped in a protecting film. Code **Z-600** suitable for 12 ml screw tubes, series **301402**, and for 15 ml centrifuge tubes, series **429900** (See chapter of tubes)



code	dimensions mm	Ø hole mm	case quantity	case weight	case volume
Z-500	165 x 85 x 50	12	10	3.04	0.012
Z-600	220 x 110 x 50	17	10	4.48	0.010

### Stainless steel racks 5 x 5 holes

Stackable. Alpha-numerical index for better sample location. Supplied encased and interlocked, wrapped in a protecting film. Code **Z-800** suitable for 12 ml screw tubes, series **301402**, and for 15 ml centrifuge tubes, series **429900** (See chapter of tubes).



code	dimensions mm	Ø hole mm	case quantity	case weight	case volume
Z-700	85 x 85 x 50	12	10	1.90	0.010
Z-800	110 x 110 x 50	17	10	2.46	0.010

Minimum unit sale: 1

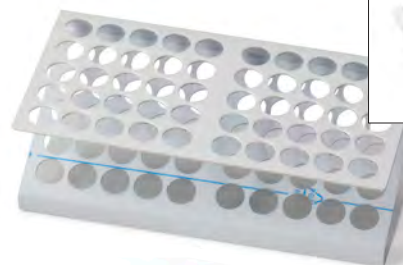
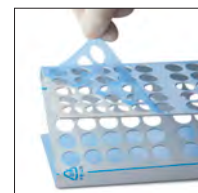

SAMPLE STORAGE



### Stainless steel racks

For tubes of 12 mm Ø, hole 13 mm Ø.  
Rack with appendix for stacking.



code	length x width x height mm	tubes capacity	quantity	weight	volume
F-210	155 x 80 x 35	50 (10 x 5)	1	0.13	0.0006

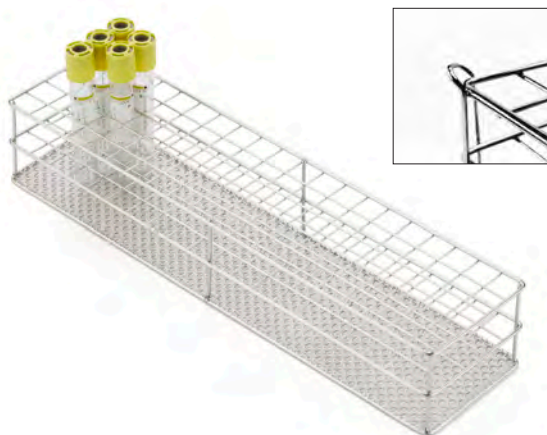

### Stainless steel racks

For tubes of 14 mm Ø, hole 15 mm Ø.  
Rack with appendix for stacking.



code	length x width x height mm	tubes capacity	quantity	weight	volume
B-200	175 x 175 x 60	100 (10 x 10)	1	0.24	0.0028

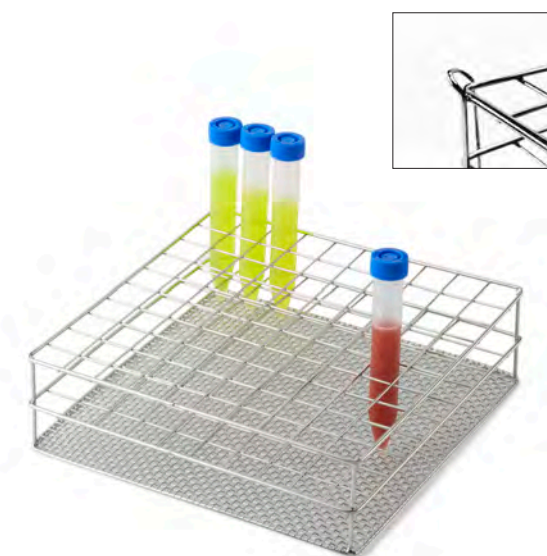

### Stainless steel racks

For tubes of 18 mm Ø, hole 19 mm Ø. Codes **A-202**, **A-212**, **A-222** and **A-242** are suitable for 12 ml screw tubes, series **301402**, and for 15 ml centrifuge tubes, series **429900** (See chapter of tubes).  
Racks with appendix for stacking.



code	length x width x height mm	tubes capacity	quantity	weight	volume
A-250	87 x 65 x 60	12 (4 x 3)	1	0.07	0.0007
A-240	125 x 85 x 60	24 (6 x 4)	1	0.11	0.0001
A-231*	169 x 128 x 40	48 (8 x 6)	1	0.20	0.0008
A-201	210 x 210 x 40	100 (10 x 10)	1	0.33	0.0028
A-211	210 x 110 x 40	50 (10 x 5)	1	0.18	0.0012
A-200	210 x 210 x 60	100 (10 x 10)	1	0.32	0.0043
A-210	210 x 110 x 60	50 (10 x 5)	1	0.19	0.0021
A-202	210 x 210 x 85	100 (10 x 10)	1	0.34	0.0062
A-212	210 x 110 x 85	50 (10 x 5)	1	0.21	0.0034

\* Only model without stacking appendix.

## Racks for containers up to 23 mm Ø

Made of stainless steel. 25 mm square holes.  
Features a strong woven mesh base.



Suitable for glass tubes shown on pages 153-155



code	length x width x height mm	tubes capacity	quantity	weight	volume
D-250	111 x 84 x 85	12 (4 x 3)	1	0.10	0.0013
D-240	165 x 110 x 85	24 (6 x 4)	1	0.16	0.0020
D-230	219 x 166 x 85	48 (8 x 6)	1	0.26	0.0042



## Racks for containers up to 28 mm Ø

Made of stainless steel. 30 mm square holes. Features a strong woven mesh base.  
Ref. C-256 with appendix for stacking.



Suitable for containers shown on pages 41-43



code	length x width x height mm	tubes capacity	quantity	weight	volume
C-256	200 x 70 x 60	12 (6 x 2)	1	0.13	0.0012
C-211	315 x 160 x 60	50 (10 x 5)	1	0.30	0.0039

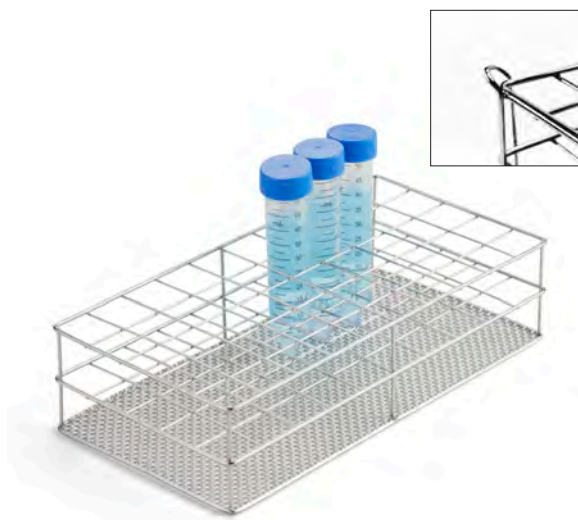

## Racks for containers up to 28 mm Ø

Made of stainless steel. 30 mm square holes.  
Features a strong woven mesh base.  
Racks with appendix for stacking.



Suitable for containers shown on pages 116-117



code	length x width x height mm	tubes capacity	quantity	weight	volume
C-254	195 x 65 x 40	12 (6 x 2)	1	0.12	0.0008

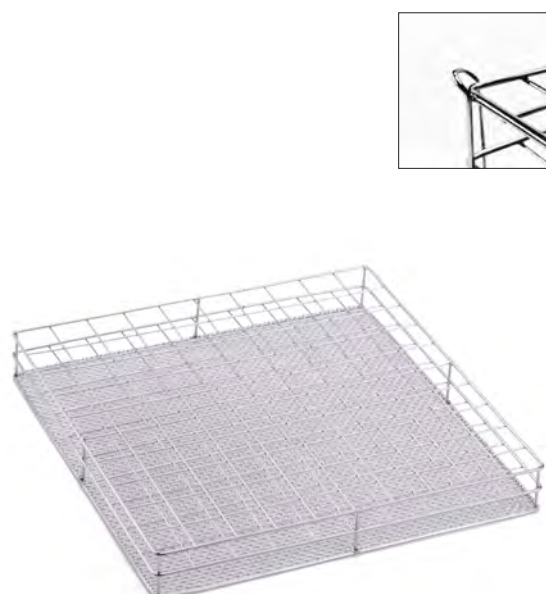

SAMPLE STORAGE

## Racks for containers up to 30 mm Ø

Made of stainless steel. 33 mm square holes. Features a strong woven mesh base.  
Ref. R-292 and R-293 with appendix for stacking.



code	length x width x height mm	containers capacity	quantity	weight	volume
R-292	137 x 104 x 85	12 (3 x 4)	1	0.12	0.0017
R-293	171 x 171 x 85	25 (5 x 5)	1	0.22	0.0035
R-281	138 x 70 x 92	8 (4 x 2)	1	0.11	0.0017
R-282	138 x 138 x 92	16 (4 x 4)	1	0.15	0.0020
R-283	206 x 206 x 89	36 (6 x 6)	1	0.60	0.0050



## Plastic tray for blood collection tubes

Made of sturdy autoclavable polypropylene. Colour: white Ideal to carry material from lab to patient. Designed for flexibility and versatility, this tray can be arranged to meet your specific needs. It includes two 40-place test tube supports (for tubes up to Ø 16 mm) and one 18-place slide holder (for 76 x 26 mm slides), a large requisition section, and adjustable partitions to hold varied materials. The handle is formed by an end mounted, detachable loop that is 178 mm high.



code	dimensions mm	quantity	weight	volume
M-300	356 x 292 x 51	1	1.38	0.017

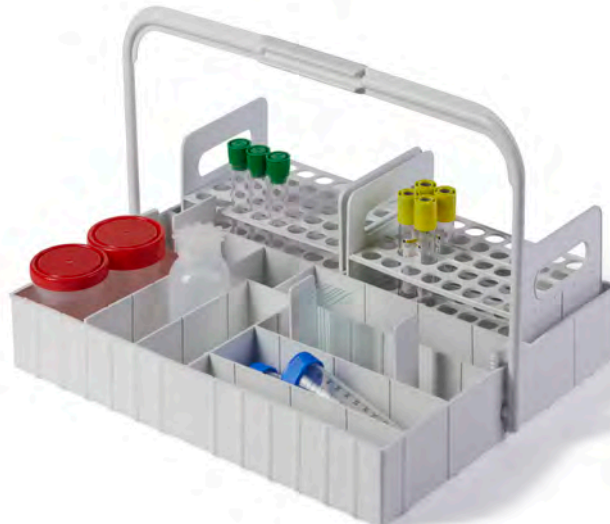

### Racks for containers up to 38 mm Ø

Stainless steel. 40 mm square holes. With a strong woven mesh base.  
Ref. L-240 with appendix for stacking.



Suitable for containers shown on pages 122-123



code	length x width x height mm	containers capacity	quantity	weight	volume
L-250	170.5 x 129 x 45	12 (4 x 3)	1	0.14	0.0013
L-240	255 x 170 x 43	24 (6 x 4)	1	0.25	0.0023



### Racks for containers up to 47 mm Ø

Stainless steel. 50 mm square holes. With a strong woven mesh base.  
Rack with appendix for stacking.



Suitable for containers shown on pages 124-127



code	length x width x height mm	containers capacity	quantity	weight	volume
I-240	315 x 210 x 45	24 (6 x 4)	1	0.35	0.0042



### Racks for containers up to 58 mm Ø

Stainless steel. 63 mm square holes.  
Ref. N-240 with appendix for stacking.



Suitable for containers shown on pages 124-129

code	length x width x height mm	containers capacity	quantity	weight	volume
N-240	393 x 262 x 45	24 (6 x 4)	1	0.46	0.0056
N-250	393 x 132 x 45	12 (6 x 2)	1	0.37	0.0029



SAMPLE STORAGE



### Bottle carrier with folding handlers

Manufactured in stainless steel and designed for the transport of six 1 liter bottles such as chemical reagent bottles.



See our range of bottles and containers in chapter  
**Laboratory and industrial packaging**



code	length x width x height mm	quantity	weight	volume
19700	380 x 240 x 130	1	1.34	0.018



### Instrument trays

Made of stainless steel thick woven mesh. Reinforced construction to withstand weight. With not folding handles.



code	length x width x height mm	quantity	weight	volume
T-200	370 x 240 x 80	1	1.06	0.016



SAMPLE STORAGE



### Racks for bags

Made of stainless steel, specially designed for Stomacher type homogenizer bags.

**Dimensions:** 390 x 200 x 240 mm.



See more Stomacher type homogenizer bags  
in chapter **Containers. Sampling**



code	description	quantity	weight	volume
15006	rack for 14 bags	1	1.77	0.039
983047	clips to adjust bags	200	4.30	0.0114

Customer-designed models can be produced. Please ask the sales department.

## Square baskets with optional lid

Made of stainless steel. Feature a strong woven mesh base. Baskets have a folding handle for more convenience and are available with or without lid. To order baskets with lids, simply add **T** to the end of product code (ex: **H-200T** to order the first model with a lid). Minimum order quantity: 5 units. Other models with internal divisions are available on request. Please ask our sales department for more details.



code	length x width x height mm	quantity	weight	volume
H-200	120 x 120 x 145	1	0.26	0.004
H-210	160 x 160 x 140	1	0.40	0.005
H-215	140 x 140 x 140	1	0.50	0.003
H-220	210 x 210 x 180	1	0.65	0.008

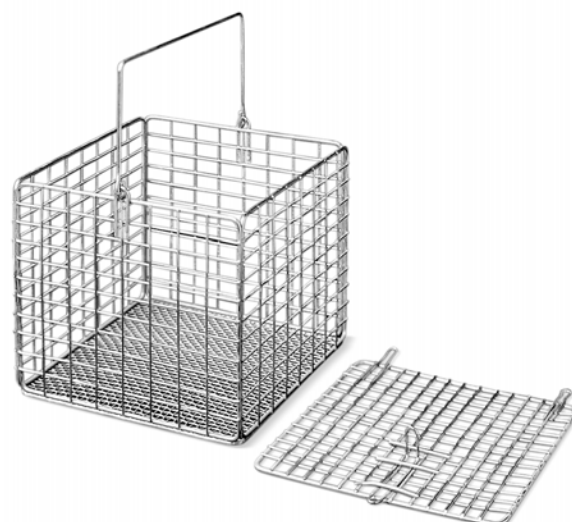

## Baskets for autoclave

Made of stainless steel.



code	length x width x height mm	quantity	weight	volume
H-290	470 x 300 x 200	1	1.40	0.028



## Round baskets with handle

Made of stainless steel, the base of these baskets is reinforced by a thick stainless steel mesh for added strength. Baskets feature a folding handle for more convenience. Other models with inner crossed dividers are available on request. Please ask our sales department for more details.



code	height mm	diameter mm	quantity	weight	volume
R-215	150	200	1	0.35	0.006
R-240	180	230	1	0.56	0.010
R-250	180	240	1	0.53	0.010



## Stainings racks for microscope slides

Made of stainless steel.  
Dimensions: 435 x 85 mm.



code	description	quantity	weight	volume
S-004	for 12 slides	1	0.25	0.003
S-003	without divisions	1	0.21	0.003



SAMPLE STORAGE





# 10. HYGIENE, SAFETY AND GENERAL LABWARE



## Classification of sanitary waste by type:

**Type I waste:** medical waste treated as municipal waste. Easy management (cardboard, paper, office equipment, kitchens, garages, gardening and non-infectious patients waste).

**Type II waste:** non specific medical waste. Preventive measures in the handling, collection, storage and transport in the field of health center (dressing materials, plasters, clothing and single-use material contaminated with blood, secretions and/or excretions).

**Type III waste:** specific health waste or risk waste. Preventive measures in the handling, collection, storage, transportation, treatment and disposal, as they may pose a health risk to workers and the public. They can be divided into 5 groups: medical waste or infectious anatomical waste, blood and blood products in liquid, needles, sharps and live attenuated vaccines.

**Type IV waste:** waste specified in singular regulations. Subject to especial requirements from the point of view of hygiene and environment. Include: cytostatic waste, chemical residues, expired pharmaceuticals, minerals and synthetic oils, waste metals, radioactive waste and human anatomical remains entity.

Source: NTP 372 – Spanish National Institute of Safety and Health at Work.

## Safety containers

Containers manufactured with virgin raw materials enabling incineration; four and six liters containers are made in autoclavable polypropylene, the rest in polyethylene. **Suitable for solid waste type II and III.**

They are made of a body bearing the hazard warning label, and two lids:

- The first offers an entire opening, taking advantage of the total diameter of the mouth of the container; very useful to throw away bigger volume waste. May be closed hermetically and definitively
- The secondary one presents a partial opening, which may be closed temporarily or definitively. It embodies two devices in order to easy the extraction/ disconnection of dental and analytical needles, and a 70 x 42 mm rectangular hole. All containers, except code **241500**, embody a handle.

mod.	code	capacity l	material (body and lid)	Ø mouth mm	Ø base mm	height mm	case quantity	case weight	case volume	cases per pallet
1	242000	2.0	PP	143	125	160	60	8.90	0.116	12
2	243500	3.75	PP	195	175	157	40	10.00	0.144	12
3	246000	6.7	PP	220	194	203	20	7.82	0.146	12
4	240007	7.3	PP	220	190	238	20	7.80	0.144	12

In accordance with major European and international standards (ONU ADR, etc.)



1

2

3

4



## Safety containers

These containers are manufactured in virgin raw materials enabling incineration. Suitable for solid waste type II and III. They are made of a body bearing the hazard warning label, a handle, and two lids, allowing two using options:

- Total opening, taking advantage of the total diameter of the mouth of the container; very useful to throw away bigger volume waste
- Partial opening, 120 mm diameter, usable for syringes, contact plates, and midsize waste

Code **240028** is total opening only.

mod.	code	capacity l	material (body / lid)	Ø mouth mm	Ø base mm	height mm	sales unit	sel.ut. weight	sel.ut. volume	cases per pallet
1	240011	11.1	PE / PP	260	222	262	10	4.69	0.050	400
2	240021	22.8	PP / PP	315	277	348	10	9.39	0.090	190
3	240028	26	PP / PP	322	278	391	10	9.71	0.100	100

In accordance with ONU standards and major European standards.



1



2



3

## Safety labelling

Permanent adhesion labelling to alert from risk or danger. Labels are shiny and fluorescent. In compliance with international safety standards. Recommendable temperature of use:

- Codes **901531**, **901533**: from **-50 °C** to **105 °C**

mod.	code	description	bag quantity	bag weight	bag volume
1	901531	roll of 500 labels (labels size 25 x 25 mm)	500	0.07	0.0002
2	901533	bag of 10 units 200 x 250 mm	10	0.06	0.0010



1

2

## Needle collection container

Made of high density polyethylene. Instructions for use (in English and Spanish) are printed on the containers. Capacity: 1 l. It features two caps. The first one has a mouth which embodies three different devices to remove needles. The other one is designed to close the container temporarily or definitively.

code	colour	dimensions mm	case quantity	case weight	case volume
90	yellow	Ø mouth 70; Ø base 100; height with cap 173	76	7.90	0.150



## Safety containers

Design that aims to reduce sharps injuries by bringing boxes as close to the point of care as possible in trays designed with multiple depressions. Sharps are safely disposed of at the "point of use", eliminating many risks of injury. Made from recycled plastic.

Fit for purpose and tailored to the demands of all types of healthcare and technical departments such as treatment rooms and laboratories and technical facilities.

One-handed disconnect. Strong handle for carrying.

Puncture resistant.

**Autoclavable at 134°C** for 18 minutes, with the lid open.

**A**  
mod. 1, 2, 3

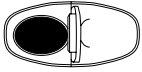

Oval opening for syringes and lancets.

**B**  
mod. 4



Removal of needles with non return system and luerlock and pen needles.

**C**  
mod. 5, 6, 7

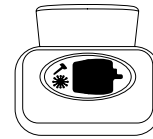

Five kinds of aperture: a wide one to discard elements of medium size; another one designed to remove scalpel blades; one to remove luerlock and blood collection systems; to remove butterfly and luerlock needles and the last one for insulin pen.

Complies with ISO 23907-1:2019; TRBA 250 and ADR UN 3291 standards. Directive 94/62/EC on Packaging and Packaging Waste. Law 11/1997 on packaging and packaging waste.



mod.	code	capacity l	container dimensions mm	opening devices	useful capacity l	container weight g	case quantity	case weight	case volume
1	232820	0.20	79 x 39 x 146	A	0.17	51	100	6.22	0.040
2	232831	0.45	105 x 50 x 170	A	0.38	83	100	9.88	0.080
3	232826	0.60	108 x 52 x 224	A	0.45	111	100	12.30	0.112
4	232829	1.00	90 x 108 x 187	B	0.85	123	100	13.70	0.093
5	232828	2.00	197 x 126 x 177	C	1.67	220	50	12.50	0.092
6	232821	4.00	175 x 175 x 245	C	3.21	297	50	16.73	0.130
7	232822	7.00	175 x 175 x 380	C	5.54	401	50	23.78	0.200

These models are constantly updated; design can be slightly modified.



## Rectangular waste container (PP)

Made of yellow, perforation resistant, virgin polypropylene. Suitable for solid or semi-solid waste, II and III groups. Lids feature a central handle for a better handling in the daily use and also while carrying containers. Secure closure thanks to their fourteen closing points. Lateral handles for further help carrying. Can be incinerated with no release of toxic fumes. Stackable when empty, or full and closed. Minimum wall thickness: 2.5 mm. Closing sealed for air and gas.

Manufactured following new French Standard NFX 30 505.



mod	code	capacity l	container dimensions mm	maximum load (ADR) kg	weight ut. g	pallet dimensions	pallet quantity	case quantity	case weight	case volume
2	240065	63	415 x 314 x 575	25	1,984	80 x 120 x 200	100	10	19.84	0.17

## Cardboard waste containers

Cardboard containers with lid, designed for storage and disposal of group II solid and semi-solid waste. With an integrated low density polyethylene bag (stuck in their interior). They can be incinerated without release of toxic fumes. The lid features two seals. One temporary that will avoid unpleasant smells and eliminate the risk of contamination while using the container. The second one is a definitive, positive seal: closing the bag with a belt already included, sealing the lids, and reinforcing them with an adhesive tape. These containers embody lateral handles.

**Model 2**, code **270055**, 50 l capacity, is made of cardboard 2.7 mm minimal thick. PEBD 60 µ bag, adhered to the base and the walls. **Its height allows users not to need to lean forward as they throw away waste.** Easy to assemble thanks to its auto-mountable bottom. A maximum filling line is printed on its body.

**Model 3**, code **270060**, 50 l capacity, is manufactured in **reinforced cardboard, double thickness** (4 mm minimum). PEBD bag 54 µ adhered to the base. Safe closure with the help of raised edges. Both are printed with the biohazard anagram and text; assembling and closing instructions and drawings; identification form, and standards. Suitable for liquid and solid products or products with a certain level of humidity. Containers are supplied folded up for space-saving. Those containers are not suitable for needle disposal. For this purpose see the special containers on previous pages.

In accordance with UN ADR (road transport), and manufactured pursuant new French Standard NFX 30 507.



mod	code	capacity l	container dimensions mm	maximum load (ADR) kg	weight ut. g	pallet dimensions	pallet quantity	case quantity	case weight	case volume
2	270055	50	263 x 263 x 756	12.5	660	100 x 120 x 180	40 x 10	400	264	1.80
3	270060*	50	355 x 263 x 485	12.5	570	355 x 263 x 485	330	300	155	0.09



## Sterilization indicator tapes

Self-adhesive sterilization indicator tapes made of semicreped paper. It sticks on different surfaces such as plastic, metal, fabrics, paper, cardboard, etc. The tapes have high tack adhesive and they offer good resistance to heat and moisture. Also, the tapes are resistant and it is hard to break them.

### 1. Code 191049

Tape designed to check what individual units have been exposed to Ethylene Oxide (EO) sterilisation. Also, it is used to distinguish between sterilized and non sterilized units during their storage. The orange printed stripes turn yellow after ethylene oxide EO sterilization, by the following specifications:

- Exposition to 600 mg/l EO and 60% of relative humidity (RH) for minimum 20 min. at **54 °C**.
- Exposition to 600 mg/l EO and 60% of relative humidity (RH) for minimum 25 min. at **37 °C**.

### 2. Code 191048

Tape designed to use with individual units, to check if the units have been exposed to dry heat/poupinel sterilisation, and to distinguish between sterilized units and non sterilized units during their storage. It must not be used in wet processes. Signals in V shape convert themselves from green to brown when it has been sterilized according to the following specifications:

- Exposition in dry air at **160 °C** or more for minimum 40 minutes.

### 3. Code 191047

Tape designed to be used with individual units to show that they have been exposed to steam (autoclave) sterilisation, and to distinguish between sterilized units and non sterilized units. Not to be used in any other process than steam sterilisation (autoclave). The tape is lead free. The printed stripes change colour from light green to medium dark green after the sterilisation of the tape by the following specifications:

- Exposition at **121 °C** for 15 min.
- Exposition at **134 °C** for 10 min.



mod.	code	type of sterilisation	length. m	width mm	case quantity	case weight	case volume
1	<b>191049</b>	ethylene oxyde gas	50	19	12	0.324	0.009
2	<b>191048</b>	dry heat (poupinel)	50	19	12	0.324	0.009
3	<b>191047</b>	autoclave	50	19	12	0.324	0.009

Expiration date Mod. 1: 24 months from the production date.

Expiration date Mod. 2 & 3: 30 months from the production date.

## Sterilization indicator tapes

For steam **autoclave**.

Resistance to coldness: **-40 °C**.

**Model 1:** The tape has printed on it **CONTAMINATED**.

After sterilisation to **121 °C** the word **STERILIZED** appears.

**Model 2:** The tape has printed on it **-Batch, -Con. (Control) and -Date**.

After sterilisation to **121 °C** the word **STERILIZED** appears.



mod.	code	description	case quantity	case weight	case volume
1	<b>191222</b>	roll of 19 mm x 13 m	8	0.33	0.0007
2	<b>191223</b>	roll of 19 mm x 13 m	8	0.33	0.0007



## Bags for Autoclave

Printed with the biohazard graphic symbol and instructions of use in five languages. Do not close the bags hermetically when placing them in the autoclave a **121°C**.

Code 200100 is made of an autoclavable polyethylene, while the rest of the codes are manufactured in autoclavable polypropylene.



code	dimensions cm	materiel	aprox. capacity l	tickness microns	bag quantity	bag weight	bag volume
200310	30 x 60	PP	12	37.5	500	5.99	0.013
200311	40 x 75	PP	24	37	300	6.10	0.023
200100	50 x 75	PE	34	30	100	2.05	0.006
200312	60 x 75	PP	49	37	200	6.25	0.020
200318	75 x 90	PP	100	37	100	4.36	0.011

Minimum order quantity: 50.000 pieces.



## Autoclave resistant red bags

Heavy duty, high impact biohazard bags made of a 0.055 mm thick high molecular weight polypropylene blend.

They are **autoclavable to 138 °C**, saving autoclave time.

Bags printed with the standard biohazard warning symbol and warning procedures in four languages: English, Spanish, French and German.

They feature a **sterilization indicator** patch that darkens when exposed to steam sterilization. Do not close the bags hermetically when placing them in the autoclave.

code	dimensions cm	volume l	case quantity	case weight	case volume
200320	48 x 58	24.4	200	5.10	0.011
200321	65 x 91	75.1	200	10.93	0.017
200322	78 x 96	121.0	200	13.25	0.029





## Coloured adhesive tapes for sample identification

Ideal for use in freezers, autoclaves, etc. Peel off without leaving a sticky residue. Withstand temperatures from **-50 °C** to **130 °C**.

High resistance to oils, acids, water, etc.  
Suitable for glass, plastic, paper, metal and rubber surfaces.

Can be marked with pencil, ball-point pen, etc. All tape models are 19 mm wide.

The code **191220** is a 8 roll tape metal dispenser that accepts 13 m rolls. The dispenser has the following **dimensions**: 31x7x13 mm. 55 mm tapes not compatible.



code	colour	Ø mm	case quantity	case weight	case volume
<b>13 m tape roll</b>					
191221/1	white	26	16	0.64	0.001
191221/2	red	26	16	0.64	0.001
191221/3	yellow	26	16	0.64	0.001
191221/4	green	26	16	0.64	0.001
191221/5	orange	26	16	0.64	0.001
191221/6	blue	26	16	0.64	0.001
<b>55 m tape roll</b>					
191221.1	white	76	12	1.78	0.005
191221.2	red	76	12	1.78	0.005
191221.3	yellow	76	12	1.78	0.005
191221.4	green	76	12	1.78	0.005
191221.5	orange	76	12	1.78	0.005
191221.6	blue	76	12	1.78	0.005
<b>Dispenser</b>					
191220	white	-	1	2.75	0.005

Minimum order quantity: 1

## Adhesive labels

White colour.



code	description	bag quantity	bag weight	bag volume
901031	55 x 37 mm printed	5.000	1.15	0.002
901031.2	55 x 37 mm plain	5.000	1.20	0.003
901030	35 x 25 mm printed	2 x 7.500	2.25	0.006

Check with our sales department for other dimensions.



## Safety glasses

Made of polycarbonate (1.5 mm thickness).  
Scratch resistant, antifogging, antistatic lenses.  
Protect against UV rays.  
With lateral vents. Comply to EN 166 standard.  
**Eyepiece dimensions:** 145 x 65 mm.



code	description	quantity	weight	volume
19385	glasses	5	0.49	0.003



## Safety glasses

Made of polycarbonate (2 mm thickness).  
Can be worn over conventional corrective glasses.  
Comply to EN 166, EN 167 and EN 168 Standard.  
**Eyepiece dimensions:** 152 x 60 mm.



code	description	quantity	weight	volume
19386	glasses	12	0.69	0.004



## Emergency eyewash bottle

Made of low density polyethylene, the bottle is flexible and easy to squeeze. The bottle has an eyecup with a snap-on cap. The eyecup has a perforated plate to break up the stream providing a gentle spray to the eye. A capped air vent valve prevents drawback of contaminated eye wash into bottle. Contaminated wash exits through a drain tube, which rotates in any direction.

Instructions for use printed in various languages.

Bottle capacity: 1 l.

Supplied empty.

code	capacity ml	case quantity	case weight	case volume
19384	1,000	1	0.26	0.004





### Pipetting bulb

This one-handed design is the simplest safety pipette filler to use available. Made of natural orange rubber. Approx. drawn capacity: 25 ml. Single hand use, only two operating points. Evacuate via the automatic valve. Standard model, accommodates all pipettes. The inside bulb can be cleaned by removing the patented valve and rinsing out.

code	description	bag quantity	bag weight	bag volume
19200	pipetting bulb	1	0.05	0.0004



### Pipetting bulb

Made of rubber. Used to avoid mouth pipetting and contamination risk. Can be opened, cleaned and **autoclaved**. Ideal for Wintrobe and Westergren pipettes.



code	description	bag quantity	bag weight	bag volume
19201	red pipetting bulb	1	0.04	0.0002

### Pipette pumps

Several models for various pipette volumes. Designed for fast and efficient pipetting with simple, one handed operation. Pipettes fit smoothly into collar. Rotate the knurled thumb wheel on the side for precision filling or dispensing, and press the fast release lever for quick emptying.

Easy to use and easily disassembled for cleaning. Sizes are colour coded. Pipette pumps resist acids and alkalis.

Presentation in individual box.



code	description	colour	bag quantity	bag weight	bag volume
W-100	up to 2 ml	blue	1	0.06	0.0002
W-110	up to 10 ml	green	1	0.06	0.0002
W-120	up to 25 ml	red	1	0.06	0.0002



## Wash bottles

Made a combination of high and low density polyethylene. Translucent bottle, with HDPE cap (blue), delivery tube and seal cap (natural).  
Bottle caps are ribbed for a better handling.  
High resistance to all liquids, acids and bases.  
Include a large neck for safe and easy filling.

code	capac. ml	neck mm	base mm	height mm	case quantity	case weight	case volume
44300000	500	30	75	185	60	4.85	0.080
44310000	1,000	30	90	222	45	5.02	0.110



## Wide mouth wash bottles

Translucent low density polyethylene bottles, with screw cap and delivery tube available in 4 different colours (natural, blue, yellow and red) for easy identification.  
Feature a one piece cap and delivery tube assembly, thus eliminating air or liquid absorption through the cap.  
Include a wide neck for safe and easy filling.  
Ribbed caps for a better handling while opening and closing.  
Moulded-in graduations.  
250 ml model is graduated in 25 ml increments, 500 ml model, in 100 ml increments.



code	capac. ml	cap colour	int. neck Ø mm	base Ø mm	height mm	case quantity	case weight	case volume
191637	250	natural	38	60	140	10	0.64	0.018
191637.04	250	blue	38	60	140	10	0.64	0.018
191637.06	250	yellow	38	60	140	10	0.64	0.018
191637.10	250	red	38	60	140	10	0.64	0.018
191638	500	natural	38	75	165	10	1.01	0.019
191638.04	500	blue	38	75	165	10	1.01	0.019
191638.06	500	yellow	38	75	165	10	1.01	0.019
191638.10	500	red	38	75	165	10	1.01	0.019



## Integral wash bottles

Made of translucent polyethylene. Feature a one piece cap and delivery tube assembly, which eliminates air or liquid absorption through the cap and ensures a positive leaktight seal. To increase liquid flow, cut the tip of the delivery tube; close the tip by means of the cap attached to the delivery tube.  
Caps are ribbed for a better handling while opening and closing.  
Tagging points on neck and cap for a tamper proof closure. Bottles include a fill in line.

code	capac. ml	height mm	neck d/n std.	case quantity	case weight	case volume
191633	250	143	GL32	10	0.68	0.008
191634	500	181	GL32	10	0.84	0.015





## Wood tongue depressors

Tongue depressor with smooth rounded edges. Made from high-quality wood to provide a smooth, splinter-free finish. Odour and taste-free. Maintains a high tensile strength. In addition to their traditional use, depressors can be used for spreading balms and ointments, for stirring liquids or mixing medicine, etc. The sterile models are supplied with "instructions for use".

Size: 15 x 1.8 cm.



code	description	case quantity	case weight	case volume	cases per pallet
441142	non sterile	50 x 100	13.78	0.027	40
441242.2	STERILE EO individual flow-pack	4 x 500	12.66	0.070	24

Sterile models are supplied with "instructions for use".



## Plastic tongue depressors

Made of polystyrene. Colour: cream. Tongue depressor with smooth rounded edges. Odour and taste-free. Maintains a high tensile strength. More flexible than wood depressors. Features a ribbed finger rest for easy handling. In addition to their traditional use, depressors can be used for spreading balms and ointments, for stirring liquids or mixing medicine, etc. Size: 16 x 2 cm.



code	description	case quantity	case weight	case volume	cases per pallet
441142.1	non sterile	6 x 250	8.30	0.014	108
441142.2	STERILE EO individual flow-pack	4 x 500	12.66	0.070	24

Sterile models are supplied with "instructions for use".



## Absorbent paper

This 125 g/m<sup>2</sup> absorbent paper provides a total protection thanks to its two layers. The top side consists of a layer of cellulose of great liquid absorption power; the reverse side consists of a layer of polyethylene ensuring that it is completely waterproof. For use in the following applications:

- laboratory trays and tables protection.
- seed germination (between-paper method).
- spillage recovering using its leaktight surface.
- particularly suitable for working with materials that are valuable (precious metals) or hazardous (toxic or corrosive materials)

Paper thickness: 0.250 mm. Absorption: 240 g/m<sup>2</sup>. Klemm absorption: 86 mm.

code	description	case quantity	case weight	case volume
120003	50 m x 50 cm reel	1 reel	3.01	0.009
120002	50 x 50 cm sheets	1 x 100 sheets	2.90	0.008

## Filter paper

Our range of filter paper reams is made from high quality cellulose fibers to ensure a good resistance to humidity and a high absorption capacity. Pore diameter: ± 30-40 microns. For use in the following applications:

- laboratory worktop protection
- simple filtering operations for varied products
- labware sterilization
- pharmaceutical product preparation

code	sheet size cm	grammage	thickness mm	Klemm absorp. (mm)	case quantity	case weight	case volume
120010	50 x 50 cm	73 g/m <sup>2</sup>	0,170 ±0,02	89	1x100 sheets	2.04	0.006

Capillary rise of water. Klemm Method (UNE 57044): SL> 75 ST> 70.



## Urine collection bottle

Rounded rim on the neck of the bottle. Inner diameter of the neck is 50 mm, outer diameter is 69 mm. Supplied **individually wrapped**. Can be sterilized by ethylene oxide. Made of polyethylene. Colour: natural.

The bottle has moulded-in graduations in 100 ml increments up to 1,000 ml. Total capacity: 1.1 l.

Codes 19591 and 19591/T have a 110 mm handle.  
Code 19591/T is the same model with a snap-on lid.



	code	description	total capacity	case quantity	case weight	case volume	cases per pallet
	1	<b>19591*</b> without lid	1 l	60	5.40	0.160	12
	2	<b>19591/T*</b> with lid	1 l	60	6,54	0,160	12
<b>NEW</b>	3	<b>C05</b> without lid, without handle	1 l	70	6.71	0.150	16

\* Supplied with bag with printed "instructions for use".



## Bed pan

Made of copolymer polypropylene with white dye, using an injection process. This material is highly resistant to bleaches and detergents, knocks and tears. It can withstand 120°C without deformation.

Rounded edges to prevent cuts. Especially suitable for hospital use, as it can be sterilised by autoclave and is suitable for washing in automatic washing machines due to its design and physicochemical characteristics.

The product is presented in a single low-density polyethylene bag, printed according to EN ISO 15223.

Capacity: 2000 ml.  
Unit weight: 435 ± 2.5% g.



code	dimensions mm	case quantity	case weight	case volume	cases per pallet
<b>19586</b>	430 x 93	20	10.69	0.140	12

Supplied with "instructions for use".



## Dental containers

Manufactured in polypropylene and intended for the hygienic storage and preservation of dental prosthesis, orthodontic sections and dental splints. It has flexible and waterproof walls and closure system by means of a front flange.

The open container is stackable, which reduces the space of storage, and stackable once closed, thanks to the projections in the base and the lid.

Contact the sales department for individual packaging.

code	colour	case quantity	case weight	case volume
<b>D01</b>	white	300	9.4	0.070
<b>D03</b>	green	300	9.4	0.070



### Glove properties chart

	LATEX	NITRILE	VINYL
<b>Mechanical resistance</b>			
Perforation	●	●	●
Tearing	●	●	●
Adequate for foodstuff handling	●	●	●
Comfort	●	●	●

Maximum resistance of nitrile gloves 125 °C.

- Excelent
- Good;
- Limited
- Not recommended

These indications are solely for information. It is strongly recommended that the user carries out preliminary testings.

### Glove chemical resistance chart

<b>Diluted mineral acids</b>			
Hydrochloric acid	●	●	●
Chromic acid	●	●	●
Nitric acid	●	●	●
Perchloric acid	●	●	●
Phosphoric acid and Sulphuric acid	●	●	●
<b>Concentrated acids</b>			
Hydrochloric acid	●	●	●
Chromic acid	●	●	●
Nitric acid	●	●	●
Sulphuric acid	●	●	●
<b>Hydrocarbon and oil by-products</b>			
Aniline	●	●	●
White spirit	●	●	●
Styrene	●	●	●
Gasoline, Hexane, Paraffine, Kerosene	●	●	●

### CHOOSE YOUR GLOVE SIZE - MEASURE YOUR HAND

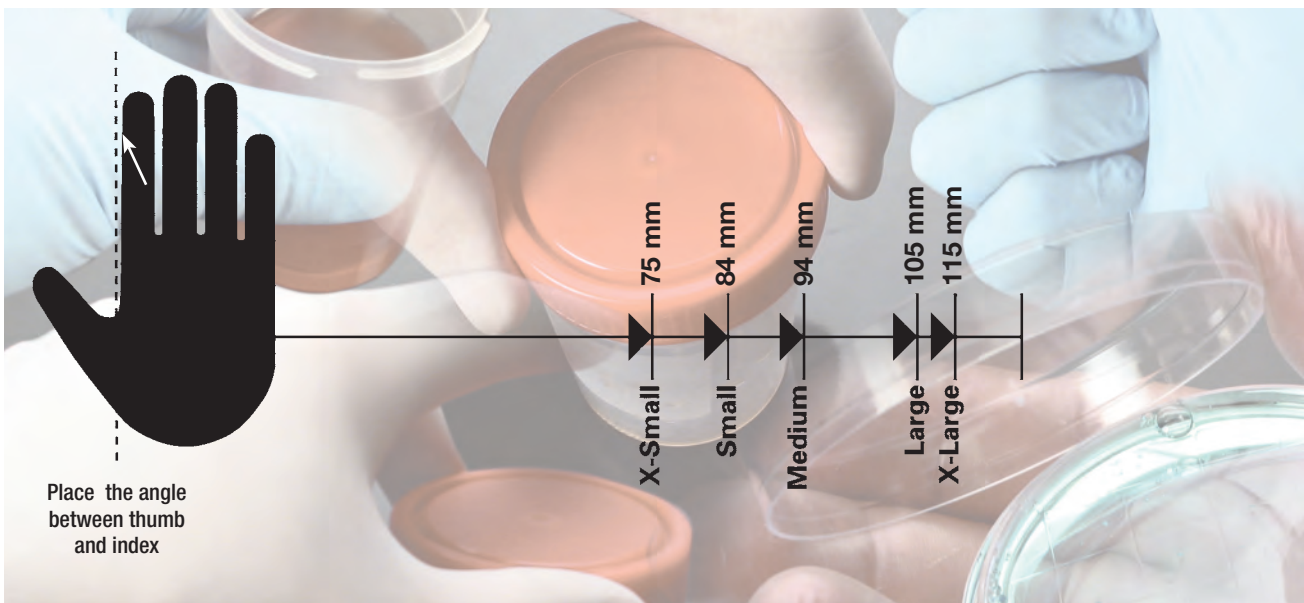

Place the angle between thumb and index

### Safety gloves

Providing superior protection when handling hot, cold or damp objects. Made of strong non toxic silicone rubber which resists tearing and withstands temperatures from **-55 °C** up to **260 °C**. Thumb and fingers fit into end pockets. The gripping surfaces have multiple concave tipped studs for non-slip grip (48+48 studs).



code	dimensions mm	case quantity	case weight	case volume
19270	190 x 100	1	0.19	0.001

## Latex gloves

Single use gloves, suitable for medical, laboratory use, industries, etc. Made of top quality natural colour latex. Supplied in convenient dispenser boxes of 100 units. Ambidextrous, ergonomic and have beaded cuffs, which makes them more resistant. Non sterile.

In compliance with regulations:

- Regulation (EU) 2017/745.
- Regulation 2016/425 EPI (Cat.III).
- European Standards EN 455, EN 374, EN 420, EN 380.
- Micro perforations Inspection Level: AQL 1.5
- Free of all chemicals contained in the “candidate list” of REACH.

**Thickness:**

**Latex gloves without powder**

Finger: 0,10 mm (± 0,03 mm)

Palm: 0,09 mm (± 0,03 mm)

Fist: 0,07 mm (± 0,03 mm)



code	size	case quantity	case weight	case volume
1020LP	small (6-7)	10 x 100	6.11	0.020
1020LM	medium (7-8)	10 x 100	6.13	0.020
1020LG	large (8-9)	10 x 100	6.96	0.020

Expiration date: 60 months



## Nitrile gloves

Single-use gloves made of blue nitrile. Powder-free. Non sterile.

Suitable for medical and laboratory use. Supplied in convenient dispenser boxes of 100 units. Opening box with pre-dilled area at the top. Easy and convenient removal of the glove. Indication of height in dispenser box and carton. Maximum safety and waterproof gloves, they are three times more resistant than latex gloves. Ambidextrous and ergonomic.

Beaded cuff, reinforced ensuring easy installation and preventing it from rolling. High sensitivity to touch. Finish: microtextured outer surface on the fingertips, it provides greater grip strength. Chlorinated inner surface, smooth and comfortable. Use temperature range: -20 °C to 50 °C. Free of protein. Made of materials suitable for food use.

In compliance with:

- Regulation (EU) 2017/745.
- Regulation 2016/425 EPI (Cat.III).
- European Standards EN 455, EN 374, EN 420, EN 380.
- ASTM D 6978-05, ASTM F 1671, ASTM F 1670

**Thickness:**

Finger: 0,10 mm (± 0,02 mm)

Palm: 0,07 mm (± 0,02 mm)

Fist: 0,05 mm (± 0,02 mm)



code	size	case quantity	case weight	case volume
4020NP	small (6-7)	10 x 100	3.90	0.021
4020NM	medium (7-8)	10 x 100	4.20	0.021
4020NG	large (8-9)	10 x 100	4.50	0.021

Expiration date: 60 months







## Measuring cylinders with pentagonal base

Material: polypropylene. Autoclavable up to 121 °C.  
In compliance with ISO 6706 standard.



code	capac. ml	grad. ml	subdiv. ml	O.D. Ø mm	height mm	case quantity	case weight	case volume
408025	25	5	0.5	19	195	30	0.78	0.010
408050	50	10	1.0	26	200	30	1.10	0.010
408100	100	10	1.0	31	250	30	1.47	0.018
408250	250	20	2.0	41	315	12	1.40	0.015
408500	500	50	5.0	56	360	12	1.94	0.029
481000	1,000	100	10.0	66	440	6	1.58	0.029
482000	2,000	200	20.0	80	530	6	3.75	0.048

Minimum order quantity: 1.

## Graduated measuring cylinders pentagonal base

Made of polypropylene. Autoclavable up to 121 °C.  
In compliance with ISO 6706 standard.



code	capac. ml	grad. ml	subdiv. ml	O.D. Ø mm	height mm	case quantity	case weight	case volume
192562*	50	10	1.0	26	200	30	1.15	0.011
192563*	100	10	1.0	31	250	30	1.33	0.021
192564*	250	20	2.0	41	315	12	1.50	0.014
192565*	500	50	5.0	56	360	12	2.50	0.028
192566*	1,000	100	10.0	66	440	6	2.15	0.029
192567*	2,000	200	20.0	80	530	6	3.25	0.048

\*Minimum order quantity: 1.

Made of TPX®. Autoclavable up to 170 °C.  
In compliance with ISO 6706 standard.

TPX® is a trade name of Mitsui Plastics Inc. PTX (polymethylpentene) is a lightweight, high-temperature polyolefin with exceptional acoustic and electrical properties. TPX has low moisture absorption and excellent chemical resistance.

code	capac. ml	grad. ml	subdiv. ml	O.D. Ø mm	height mm	case quantity	case weight	case volume
192572	50	10	1.0	26	200	30	1.15	0.011
192573	100	10	1.0	31	250	30	1.40	0.018
192574	250	20	2.0	41	315	12	1.45	0.014
192575*	500	50	0.5	56	360	12	2.45	0.028
192576*	1,000	100	10.0	66	440	6	2.15	0.030

\*Minimum order quantity: 1.



## Volumetric flasks with stopper

Material: polypropylene. **Autoclavable up to 121 °C.**



**NOTE: NS Neck:**

The first measure refers to the inner Ø of the lower neck. The second one refers to the inner Ø of the upper neck.



code	capac. ml	height mm	Ø base mm	neck	case quantity	case weight	case volume
191484	25	132.5	36	12 / 21	20	0.24	0.002
191485	50	143.9	46	14 / 23	20	0.32	0.005
191486	100	173.8	58	14 / 23	20	0.39	0.012
191487	250	224	82	19 / 26	10	0.52	0.010
191488	500	264	100	19 / 26	10	0.60	0.018
191489	1,000	324	120	19 / 26	5	0.55	0.019

Minimum order quantity: 1.



## Erlenmeyer flasks

Material: polypropylene. **Autoclavable up to 121 °C.** Graduated..



code	capac. ml	grad. ml	neck	quantity	weight	volume
191461	125	25	14.5 / 23	1	0.03	0.0006
191462	250	25	19 / 26	1	0.04	0.0001
191463	500	50	24 / 29	1	0.10	0.0002
191464	1,000	50	29 / 32	1	0.20	0.0002
191465	2,000	100	34.5 / 35	1	0.30	0.0004





### Graduated beakers

Made of TPX. **Autoclavable to 170 °C.**  
In compliance with ISO 7506 standard.



code	capac. ml	subdiv. ml	Ø mm	height mm	case quantity	case weight	case volume
191721	50	2	42	60	20	0.29	0.004
191722	100	5	52	72	12	0.70	0.004
191723	250	10	71	96	16	1.45	0.011
191724	500	10	90	120	12	2.10	0.015
191725	1,000	20	110	149	4	1.20	0.010
191726	2,000	50	135	184	4	2.00	0.018
191727	3,000	500	160	200	2	1.80	0.014

Minimum order quantity: 1.

### Graduated beakers

Made of transparent polypropylene. **Autoclavable a 121 °C.**  
In compliance with ISO 7506 standard.



code	capac. ml	subdiv. ml	Ø mm	height mm	case quantity	case weight	case volume
191822	50	2	42	60	20	0.31	0.004
191823	100	5	52	72	12	0.35	0.004
191824	250	10	71	96	16	0.75	0.010
191825	500	10	90	120	12	1.05	0.015
191826	1,000	20	110	149	4	0.50	0.010
191827	2,000	50	135	184	4	0.60	0.018
191828	3,000	500	160	200	2	0.90	0.014
191829	5,000	500	191	230	2	1.40	0.022

### Graduated beakers

Material: transparent polypropylene. **Autoclavable up to 121 °C.**  
In compliance with ISO 7506 standard.



code	capac. ml	Ø mm	height mm	case quantity	case weight	case volume
409050	50	42	60	20	0.29	0.004
409100	100	53	72	12	0.33	0.005
409250	250	71	96	16	0.72	0.011
409500	500	90	120	12	0.88	0.015
491000	1,000	110	149	4	0.49	0.009
492000	2,000	135	184	4	0.86	0.017
493000	3,000	160	200	2	0.88	0.022
495000	5,000	191	230	2	2.00	0.022



## Beakers with three spouts

**Graduated** beakers made of ultra clear polypropylene **Autoclavable** up to 121 °C.  
Disposable.  
Moulded-in graduations.



code	volume ml	minimum order quantity	case quantity	case weight	case volume
490050	50	10	100	1.02	0.011
490100	100	25	100	1.38	0.011
490250	250	25	100	2.50	0.028
490400	400	10	100	3.30	0.044
490900	900	10	100	5.89	0.060

## Conical measuring flasks

In polypropylene. **Autoclavable** up to 121 °C.



code	volume ml	height mm	case quantity	case weight	case volume
19423	250	160	1	1.14	0.019
19424	500	180	8	1.00	0.028
19425	1,000	270	3	0.81	0.016





## Analytical funnels

Material: **polypropylene**.  
Autoclavable. 60° angle.



code	Ø mm	stem Ø mm	length stem mm	total length mm	case quantity	case weight	case volume
19146	37	5	37	63.4	20	0.06	0.0019
19147	46	5	43	79	20	0.07	0.0036
19148	66	10	62	112	20	0.20	0.0110
19150	81	11	70	132	20	0.34	0.0135
19152	100	11	82	161.5	1	0.03	0.0007
19153	120	11	86	184	1	0.04	0.0038

## High speed funnels

Material: **TPX**. With interior helicoid channels for a quicker filtration. Prevents the filter paper from sticking. Transparent. **Autoclavable**.



code	Ø mm	stem Ø mm	length mm	case quantity	case weight	case volume
19175	51	3	150	6	0.12	0.0022
19172	70	3	150	6	0.19	0.0042
19173	100	7	108	4	0.26	0.0063
19174	140	10	132	6	0.96	0.0250

## Funnels

Material: **polypropylene**.  
Autoclavable.



code	external Ø mm	internal Ø mm	exit Ø (mm)	length (mm)	stem length (mm)	quantity	weight	volume
194171	80	75	5	83	30	1	0.03	0.0001
194172	100	90	8	100	35	1	0.03	0.0005
194175	180	175	12	170	60	1	0.09	0.0013
194176	220	210	17	205	75	1	0.17	0.0028
194177	260	250	21	245	85	1	0.29	0.0081
194178	300	290	24	285	105	1	0.37	0.0110



## Powder funnels

Material: **polypropylene**.  
Autoclavable. 60° angle.



code	Ø ext. mm	stem Ø mm	stem length mm	case quantity	case weight	case volume
19167	80	15	22.20	20	0.28	0.013
19168	100	25	24.80	20	0.57	0.011
19169	120	30	27.10	1	0.05	0.001
19166	180	40	48.80	1	0.09	0.009



## «IMHOFF» sedimentation cone

Material: **SAN**. Moulded graduations according to DIN standards 12672.  
Resistant to temperatures from **-20 °C to 85 °C**.  
Graduation to 1, 2, 4, 6, 8, 10, 20, 30, 40, 60, 80, 100, 200, 300, 400, 500, 600, 700, 800, 900 et 1000 ml.



mod.	code	capac. mm	Ø mm	height mm	case quantity	case weight	case volume
1	191055	1,000	125	480	4	1.75	0.019

## Rack for sedimentation cones

Material: **PMMA**.  
For 2 cones. Resistant to temperatures from **-40 °C to 85 °C**.

mod.	code	dimensions mm	case quantity	case weight	case volume
2	191056	150 x 300 x 290	1	1.20	0.001



## Büchner funnels

Material: **polypropylene**.  
Unbreakable and easy to clean.  
Resistant to corrosion and heat.  
Autoclavable.



code	capac. ml	filter Ø mm	upper Ø mm	bottom Ø mm	holes mm	case quantity	case weight	case volume
19441	390	90	18.1	14.4	2	1	0.20	0.003
19442	810	110	29.9	20.7	2	1	0.30	0.004
19443	2,100	160	29.5	22.8	2.5	1	0.60	0.012
19445	6,000	240	37.6	32.5	3	1	1.00	0.028





## Burette clamps

Made of **autoclavable polypropylene**. Clamps can fit onto rods  $\varnothing$  8 to 14 mm. Stainless steel centre arm includes a spring and firmly holds in place the burette by means of rubber pads. Burette clamps do not obscure graduations. Suitable for all burettes. Base is supplied separately.



mod.	code	description	case quantity	case weight	case volume
1	<b>19139</b>	for 1 burette	5	0.22	0.006
2	<b>19140</b>	for 2 burettes	5	0.32	0.013

## Rectangular base for burettes

Base made of **autoclavable polypropylene**, with chromium plated steel rod. Rods can be screwed one onto the other to obtain different heights. All models come with 2 rods of  $\varnothing$  250 x 12 mm. 2 models available: base with central hole, and base with off centre hole.

mod.	code	description	case quantity	case weight	case volume
3	<b>19266</b>	base with central hole and + 2 rods	1	0.75	0.001
4	<b>19267</b>	base with off-centre hole and + 2 rods	1	0.80	0.005

Rods available separately. Please contact our sales department.

## Pipette stand

Material: **polypropylene**. Consists of a rounded base with a rod, and a circular pipette stand to hold up to 28 pipettes.

Base and pipette stand are supplied separately.

- Code **19262**, rounded base with rod, is specially designed to hold the pipette stand.
- The stand code **19265** accommodates 18 pipettes  $\varnothing$  up to 10 mm, and 10 pipettes  $\varnothing$  up to 15 mm.

The lower disc has little holes for liquid draining. The ring included with the stand allows its raising and lowering on the rod.



See chapter **Microbiology**

code	description	case quantity	case weight	case volume
<b>19262</b>	rounded base	1	0.24	0.002
<b>19265</b>	18 small and 10 large holes stand	1	0.35	0.007

## Rotary pipette stand

This stand which can hold 94 pipettes consists of 2 discs rotating on a central vertical axis for convenient pipette selection. The lower rotating disc has tapered sides and open bottoms to protect tips and allow water run off. Rotating discs are 18 cm diameter.

The pipette stand comes unassembled with instructions for quick and easy assembly.

Material: **polypropylene. Autoclavable.**

Can accommodate all our serology pipettes presented on page 41 and 204, except the 25 ml model.



code	dimensions mm ( $\varnothing$ x h)	case quantity	case weight	case volume
<b>19254</b>	230 x 480	1	0.39	0.005



## Flask weight ring

Heavy vinyl covered ring ideal to improve stability of Erlenmeyer flasks in water bath. High chemical resistance.

code	erlenmeyer capacity	internal Ø mm	quantity	weight	volume
192470	125 - 500 ml	48	1	0.32	0.0003
192471	250 - 1,000 ml	51	1	0.59	0.0010
192472	500 - 2,000 ml	57	1	0.64	0.0004



## Vacuum pump

Material: **polypropylene**. This vacuum pump combines excellent suction capacity with limited water consumption, under low pressure (0.5-1 kg/cm<sup>2</sup>) as well as high pressure (10 kg/cm<sup>2</sup>). The built-in, non return valve protects the pump from possible water back-flow. **Autoclavable**. Can be disassembled for easy cleaning.



code	description	quantity	weight	volume
191395	water jet vacuum pump	1	0.03	0.00001

Minimum order quantity: 1.



## Pipette and burette rinsing set

Made of **polyethylene and polypropylene**. Can hold pipettes and burettes of length up to 60 cm. Ensures a fast, safe washing. Ideal for use in labs where caustic and toxic materials are used.

Suggested sets:

For pipettes	1 x 19217
	2 x 19219
	1 x 19218
For shorter pipettes	1 x 19217
	1 x 19221

code	description	height mm	Ø mm	case quantity	case weight	case volume
19217*	pipette washer	734	165	1	3.35	0.08000
19218	pipette jar	650	165	1	1.80	0.04200
19219	pipette basket	650	130	2	2.00	0.02600
19221	pipette jar	500	165	1	1.50	0.03000

\* Code 19217 requires a 13mm inner diameter tube. It is not included.







## Drying rack

Wall mountable high impact polystyrene drying rack for general labware. This rack is made of a single mould 4 mm plate with 72 peg sockets.

Push-in pegs can be placed in any configuration on the rack, and are easily removable to accommodate odd shaped items.

Peg sockets have closed ends to avoid dripping and eliminate the risk of biological contamination.

Rack suitable for items with diameter of the mouth larger than 15 mm.

A **drip channel** collects dripping that drains via a drain tube provided. Includes 11 additional peg sockets (Ø 6 mm) for smaller parts.

Comes complete with a mounting kit and fixing template.

**Peg sockets Length: 100 mm**

code	dimensions mm	case quantity	case weight	case volume
19213	450 x 630 x 110	1	4.00	0.045

## Drying rack

PVC coated steel wire drying rack for general labware.

It embodies 55 pegs, and 5 brackets specially designed to hold erlenmeyer flasks and beakers. Pegs are plastic coated for better protection.

Two rings on the rack allow the rack to be mounted on the wall.

It includes a tray in order to avoid drops on the surfaces where the rack is placed.

The protectors can be either red or blue in colour.

**Peg sockets Length: 90 mm**



code	dimensions mm	case quantity	case weight	case volume
19212	640 x 360 x 140	1	2.12	0.130



## Laboratory spatulas

Material: polystyrene.

code	description	length mm	bag quantity	bag weight	bag volume
19593	spatula-spoon	210	10	0.008	0.0005
19596	spatula-spoon	180	10	0.008	0.0005



## Measuring scoops

Material: white polypropylene. **Autoclavable.**  
Made with materials suitable for food use.



code	capacity ml	food use	length mm	bag quantity	bag weight	bag volume
191057	10	✓	100	12	0.06	0.0004
191058	25	✓	135	12	0.10	0.0016
191059	50	✓	160	12	0.16	0.0045
191060	100	✓	200	12	0.29	0.0054
191062	250	✓	260	6	0.27	0.0076
191063	500	✓	315	6	0.46	0.0130
191064	1,000	✓	400	6	0.73	0.0150



## Measuring scoops

Material: high density polyethylene.  
Made with materials suitable for food use.



code	capacity ml	food use	length mm	bag quantity	bag weight	bag volume
191065	25	✓	135	12	0.08	0.0014
191066	65	✓	185	12	0.20	0.0011
191067	110	✓	215	12	0.35	0.0036
191068	150	✓	250	12	0.42	0.0040
191070	350	✓	310	6	0.39	0.0050
191071	750	✓	350	6	0.69	0.0190
191069	1,250	✓	400	6	0.99	0.0115





## PVC Pipette tray

Made of white PVC, resistant to temperatures from  $-20\text{ }^{\circ}\text{C}$  to  $80\text{ }^{\circ}\text{C}$ . **Model 1**, code **19252**, is perfect to fit inside drawers. It includes four compartments that can hold up to thirty pipettes of 1, 2, 5, or 10 ml.

**Model 2**, code **19996**. Sixteen pipettes up to 10 mm diameter can be accommodated longitudinally; laterally, seven pipettes up to 20 mm diameter. Tray edges are ergonomically designed for a better handling. It is also useful with other instruments.



See our range of pipettes on pages 45 and 205.

mod.	code	dimensions mm	case quantity	case weight	case volume
1	<b>19252</b>	426 x 300 x 30	1	0.53	0.006
2	<b>19996</b>	283 x 216 x 40	6	1.38	0.017

## PVC Antiacid trays

Resistant to temperatures from  $-20\text{ }^{\circ}\text{C}$  to  $80\text{ }^{\circ}\text{C}$ . Ideal for photographic purposes thanks to their ribbed interior surface.



code	int. dimensions mm	ext. dimensions mm	quantity	weight	volume
<b>19280</b>	200 x 150 x 45	245 x 195 x 50	1	0.15	0.0007
<b>19281</b>	250 x 200 x 60	305 x 250 x 60	1	0.24	0.0012
<b>19282</b>	320 x 260 x 70	385 x 325 x 75	1	0.47	0.0021
<b>19283</b>	350 x 300 x 80	420 x 375 x 85	1	0.52	0.0026
<b>19284</b>	430 x 330 x 90	505 x 405 x 95	1	0.79	0.0043
<b>19285</b>	520 x 420 x 90	600 x 495 x 100	1	1.15	0.0080

## ABS trays

They withstand temperatures from  $-40\text{ }^{\circ}\text{C}$  to  $85\text{ }^{\circ}\text{C}$ .



code	int. dimensions mm	ext. dimensions mm	body weight g	quantity	weight	volume
<b>195703</b>	320 x 220 x 10	353 x 252 x 21	217	20	5.72	0.014
<b>195705</b>	150 x 100 x 30	201 x 151 x 41	91	20	1.88	0.007
<b>195706</b>	260 x 110 x 30	303 x 151 x 42	134	20	2.76	0.008
<b>195707</b>	310 x 210 x 30	353 x 253 x 41	254	20	6.00	0.019
<b>195709</b>	140 x 90 x 70	202 x 151 x 81	110	20	2.36	0.008
<b>195711</b>	290 x 190 x 70	352 x 252 x 81	299	20	6.64	0.023
<b>195713</b>	380 x 270 x 10	408 x 300 x 21	345	10	3.50	0.014



## Hexagonal weighing dishes

Made of white translucent polystyrene. Easily bent into pouring spouts, the dishes enable non-spill transfer. Biologically inert, contaminant-free, they are resistant to diluted acids, aqueous solutions, alcohols and bases.

**Antistatic.** Suitable for microwave.

Will withstand temperatures from **80 °C** to **-10 °C**.

code	capacity ml	upper Ø (a) x lower Ø (b)	case quantity	case weight	case volume
1911106	9	35 x 25	500	0.28	0.001
1911107	50	64 x 47	500	1.00	0.004
1911108	200	110 x 85	500	2.30	0.007

For other sizes, consult with the sales department.

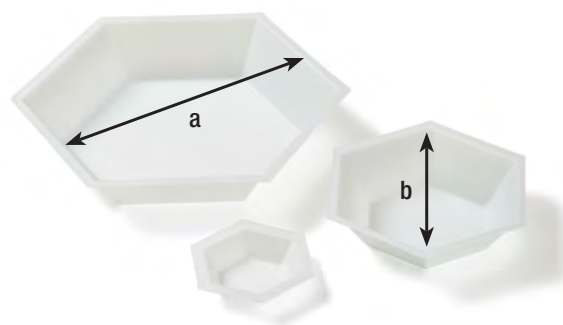

## Squared weighing dishes

Made of white translucent polystyrene.

Easily bent into pouring spouts, the dishes enable non-spill transfer. Biologically inert, contaminant-free, they are resistant to diluted acids, aqueous solutions, alcohols and bases. **Not antistatic.** Suitable for microwave.

Will withstand temperatures from **80 °C** to **-10 °C**.

Made with materials that comply with FDA regulations concerning plastic materials in contact with food (styrene waste under 21 CFR 177.1640).

code	dimensions	weight g	bag quantity	bag weight	bag volume
1911103	41 x 41 x 8	0.34	500	0.32	0.001
1911104	89 x 89 x 25	1.07	500	1.39	0.005
1911105	140 x 140 x 22	3.27	500	3.47	0.013



## Rhomboid weighing dishes

Polystyrene flexible weighing dishes with smooth surfaces to provide accurate pour-outs with minimal sample loss. Biologically inert, contaminant-free, they are resistant to diluted acids, aqueous solutions, alcohols and bases.

Wide, flat bottom to resist tipping.

**Antistatic.**

Suitable for microwave. Will withstand temperatures from **70°C** to **-10°C**.

code	capacity ml	colour	dimensions	bag quantity	bag weight	bag volume
1911110	5	white	55 x 35 x 6	500	0.200	0.0010
1911111	30	white	78 x 56 x 14	500	0.520	0.0028
1911112	100	white	119 x 90 x 19	500	1.340	0.0082
1911114	30	black	78 x 56 x 14	500	0.500	0.0025

For other sizes, consult with the sales department.



## Watch glasses

Made of **autoclavable** polypropylene. Moulded base for more stability. Easy **cleaning**.



code	weight g	Ø mm	case quantity	case weight	case volume
19454	5.5	80	10	0.06	0.002
19455	10	100	10	0.10	0.002





## Laboratory holders

Ideal for holding tubing or thermometers onto the edge of beakers or other vessels. **Autoclavable.**



code	description	bag quantity	bag weight	bag volume
19971	for tubing of up to 9.5 mm Ø Polycarbonate	6 x 6	0.13	0.0013
19972	for thermometers from 3.2 mm to 11 mm Ø Polypropylene	12 x 3	0.17	0.0018

Minimum order quantity: **19971** - 6 units **19972** - 3 units



## Tubing clamps

Material: **autoclavable** acetal.  
These clamps will not distort, rust or corrode.  
Different positions to control flow from full open to complete closure.



code	description	bag quantity	bag weight	bag volume
19505	for tubes of 3.2 to 11 mm (15 positions)	12	0.09	0.0005
19504	for tubes of 11 to 19 mm (12 positions)	6	0.11	0.0007



## «T» connectors

Material: polypropylene. **Autoclavable.**



code	fits tubing Ø mm	Ø mm* valley/crest	Ø mm int. mouth	shape	bag quantity	bag weight	bag volume
19460	6	4.5 / 5.4	2.8	T	20	0.01	0.0002
19461	8	6.9 / 7.6	4.4	T	20	0.23	0.0002
19462	10	8.7 / 9.5	6.3	T	20	0.54	0.0010

\* See the sketch.

## «Y» connectors

Material: polypropylene. **Autoclavable.**



code	fits tubing Ø mm	Ø mm* valley/crest	Ø mm int. mouth	shape	bag quantity	bag weight	bag volume
19465	6	4.7 / 5.7	2.7	Y	20	0.12	0.00018
19467	10	8.9 / 9.9	5.5	Y	20	0.03	0.00002
19468	12	10.5 / 11.6	7.3	Y	20	0.09	0.00003

\* See the sketch.



## Silicone tubing. Non toxic

Silicone for numerous applications in laboratories, medicine, pharmacy and industry. Excellent transparency. No smell. Chemical excellence in general. Excellent durability. Excellent mechanical properties. Made with materials suitable for food use. Material free of latex, phthalates and BPA. **Autoclavable.**

### General technical characteristics:

Material: Silicone elastomer (VMQ) for high temperature vulcanization (HTV).  
 Service temperature: -40° to 200°C. Tips up to 250°C. Hardness: 60° (+/-5) Sh A. Water-repellent and non-stick. Gas permeable. Excellent resistance to UV rays, oxygen, ozone. Good thermal insulator.



code	dimensions mm Ø int. x Ø ext.	bag quantity (meters)	bag weight	bag volume
350051	0.5 x 1	1 x 100	0.08	0.0011
350013	1 x 3	1 x 15	0.12	0.0010
350024	2 x 4	1 x 15	0.21	0.0016
350034	3 x 4	1 x 15	0.21	0.0043
350035	3 x 5	1 x 15	0.25	0.0026
350037	3 x 7	1 x 15	0.49	0.0032
350046	4 x 6	1 x 15	0.50	0.0026
350048	4 x 8	1 x 15	0.77	0.0043
350057	5 x 7	1 x 15	0.34	0.0039
350059	5 x 9	1 x 15	0.82	0.0047
350069	6 x 9	1 x 15	0.61	0.0100
350610	6 x 10	1 x 15	0.82	0.0096
350612	6 x 12	1 x 15	0.21	0.0043
350079	7 x 9	1 x 15	0.62	0.0091
350710	7 x 10	1 x 15	0.69	0.0076
350810	8 x 10	1 x 15	0.62	0.0091
350812	8 x 12	1 x 15	1.09	0.0054
350814	8 x 14	1 x 15	1.84	0.0008
350912	9 x 12	1 x 15	0.81	0.0120
350915	9 x 15	1 x 15	0.21	0.0043
351014	10 x 14	1 x 15	1.39	0.0081
351420	14 x 20	1 x 15	2.72	0.0240
351622	16 x 22	1 x 15	3.64	0.0320
352030	20 x 30	1 x 15	7.00	0.0490

NOTE: Tube thickness =  $\frac{\text{external } \varnothing - \text{internal } \varnothing}{2}$

## Silicone sheets

50 x 50 cm silicone sheets ideal as a laboratory benchtop protection or for use in autoclaves to protect any material.

For cleaning simply use a wet cloth.

**Resistant up to 230 °C.**



code	thickness mm	bag quantity	bag weight	bag volume
350002	2	1	0.60	0.030
350004	4	1	1.20	0.001





### «Straight» and 3 way connectors

Material: polypropylene. **Autoclavable**. Made of one piece.

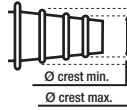

code	fits tubing Ø mm	Ø mm* valley/crest	Ø mm int. mouth	bag quantity	bag weight	bag volume
19510	4-5-6	5.5 / 4.5 / 3	2.0	20	0.16	0.00002
19512	9-8-10	11 / 9 / 6.3	4.5	20	0.06	0.00030
19513	10-11-12	13 / 10.5 / 8.3	6.5	20	0.74	0.00100

\* See the sketch.

### Disconnectors / connectors

Material: polyethylene. Very useful for connecting rubber or plastic tubing of different diameter. Made of two parts.  
Connectors fit tightly together.

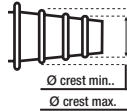

code	fits tubing Ø mm	Ø mm crest max/min	Ø mm int. mouth	bag quantity	bag weight	bag volume
19435	06-07-08	7.6 / 5.3	2.7	20	0.62	0.0010
19535	10-11-12	12.2 / 9.3	5.5	20	1.06	0.0010

\* See the sketch.

### Non-return valve

Material: polypropylene.

**Autoclavable.**

Maximum work pressure: 2 bar (2 kg/cm<sup>2</sup>).

Minimum work pressure: 0,07 bar, at 20 °C.

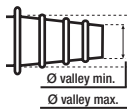

code	Ø ext valves	Ø mm valley max/min	bag quantity	bag weight	bag volume
19418	8-9-10	10.1 / 7.8	10	0.04	0.0002

\* See the sketch.

### Flow indicator

Material: SAN. Perfectly transparent.

The rotation of the red ball allows an immediate visual indication of glass or liquid flow. Very useful for connecting tubes of different diameter from 6.5 to 10 mm.

	code	dimensions mm	tubing mm	bag quantity	bag weight	bag volume
1	19538	102 x 14 x 57	6.5-10	5	0.07	0.0002
2	19539*	90 x 15 x 40	6-11	5	0.08	0.0004

\*Not for use with corrosive fluids or temperatures over 85 °C.



## Cylindrical or octahedral stirring bar assortment pack

Assorted cylindrical or octahedral stirring bars supplied in a convenient transparent plastic box including dividers for magnet classification.

Box includes 2 units of the following stirring bars:

**Code 19400:** (diameter x length in mm): 8x13, 8x15, 10x25, 10x38, 10x51 and 10x64.

**Code 19400.1:** (diameter x length in mm) 6x10, 4,5x15, 6x20, 6x25, 6x30, 8x40, 8x50, 10x60, 10x70.



code	description	quantity	weight	volume
19400	box with 12 octahedral stirring bars	1	0.25	0.0006
19400.1	box with 18 cylindrical stirrings bars	1	0.25	0.0006

## One-hand timer

60 Minute times model "Onehand" non-slip surface. Can be rewound with one hand only.



code	description	Ø x h mm	quantity	weight	volume
19901	one-hand timer	72.5 x 29.5	1	0.24	0.0003

## Digital timers

Digital timer with hours, days and months, 24 h. programme facility, 60 seconds, alarm, includes clip and small bench stand.

These digital timer count forward and down. Both include a LR44 battery.

Code **900400** includes instructions in English and German and code **900600** includes instructions in Spanish, English and French.



mod.	code	description	dimensions mm	quantity	weight	volume
1	900600	digital timer with 2 memories	64 x 61 x 14	1	0.08	0.0003
2	900400	digital timer with 1 memory	52 x 67 x 12	1	0.06	0.0003





## MAGNETIC STIRRING BARS

This section details our vast range of PTFE magnetic stirring bars. A variety of different sizes and colours is available.

- **Micro stirring bars:** for use in the smallest containers.
- **Cylindrical stirring bars:** these are the most common and lend themselves to many general applications. The diameter of the bar chosen will depend on the diameter of the flask used although it is recommended to select the largest stirring bar possible to achieve optimum results.
- **Octagonal stirring bars with pivot ring:** ideal where the base of the container may be slightly curved or irregular.
- **Triangular stirring bars:** these are used primarily to help dissolve solids or sediments. Also used for higher viscous liquids.
- **Ovoid stirring bars:** used in rounded bottom or Erlenmeyer flasks.
- **Special shape stirring bars:** cruciform stirring bars are used in round bottom tubes.



### Stirring bar retriever

Polypropylene coated.  
For the removal of stirrer magnets from vessels of all kinds.  
Includes a magnetic tip, so it is easy to remove the magnets.

code	Ø mm	length mm	bag quantity	bag weight	bag volume
19919	10	300	1	0.04	0.00002

### Micro stirring bars

For use in the smallest containers.



code	Ø mm	length mm	quantity	weight	volume
19852	2	5	1	0.04	0.0001
19855	3	8	1	0.04	0.0001
19856	3	10	1	0.04	0.0001



## Ovoid stirring bars

Used in rounded bottom or Erlenmeyer flasks.

code	dimensions mm	quantity	weight	volume
19806	50 x 20	1	0.004	0.0002



## Octahedral stirring bars with pivot ring

Ideal where the base of the container may be slightly curved or irregular.

code	Ø mm	length mm	quantity	weight	volume
19786	8	15	1	0.04	0.0001
19810	8	22	1	0.06	0.0001
19787	8	25	1	0.06	0.0001
19793	8	28	1	0.06	0.0001
19788	8	38	1	0.06	0.0001
19797	10	51	1	0.08	0.0001
19811	13	75	1	0.08	0.0001



## Cylindrical stirring bars

code	Ø mm	length mm	quantity	weight	volume
19753	3	6	1	0.04	0.0001
19748	3	8	1	0.04	0.0001
19750	4.5	12	1	0.04	0.0001
19751	6	15	1	0.04	0.0001
19756	8	20	1	0.06	0.0001
19757	8	25	1	0.06	0.0001
19758	8	30	1	0.06	0.0001
19763	6	35	1	0.06	0.0001
19764	8	40	1	0.06	0.0001
19698	8	50	1	0.06	0.0001
19705	10	70	1	0.08	0.0001



# High-quality laboratory glassware

Deltalab presents its new and complete range of laboratory glassware, designed to meet the needs of our customers.

The Dglass range stands out for its high quality and is made up of graduated flasks and pipettes, as well as graduated beakers, test tubes and bottles. These products are characterized by their high durability, precision in measurements and resistance to chemicals.

The entire Dglass range is made from transparent glass with a resistance equal to or greater than HGB3. In addition, they have quality certifications according to the ISO 17025 standard, which guarantees their total reliability in the laboratory.

All graduation marks are made using dyes or enamels tested to meet the requirements of the ISO 4794 standard.

All products can be cleaned manually or using an industrial washing machine. However, to reduce the erosion of the glass and graduations, we recommend gentle cleaning with low-alkalinity detergents at a temperature below 70°.



## Volumetric flask

CLASS AS volumetric flasks made of borosilicate glass 3.3 and certified as standard per piece. Adjusted by content (IN).  
Produced in accordance with ISO 1042 standards.  
Calibration certificate accredited to ISO 17025, on request.



code	description	capacity ml	quantity	weight	volume
703	Volumetric flask class AS	25 ml	2	0.082	0.0004
704	Volumetric flask class AS	50 ml	2	0.148	0.0008
705	Volumetric flask class AS	100 ml	2	0.225	0.0012
706	Volumetric flask class AS	200 ml	2	0,298	0.0027
707	Volumetric flask class AS	250 ml	2	0,323	0.0027
708	Volumetric flask class AS	500 ml	2	0.585	0.0049
709	Volumetric flask class AS	1000 ml	2	0.923	0.0084



## Graduated cylinder

Graduated cylinders CLASS AS, made of borosilicate glass 3.3 and certified as standard per piece. Adjusted by content (IN).  
Produced in accordance with ISO 4788 standards.  
Calibration certificate accredited to ISO 17025, on request.



code	description	capacity ml	quantity	weight	volume
750	Graduated cylinder class AS	10 ml	2	0.069	0.0008
751	Graduated cylinder class AS	25 ml	2	0.103	0.0012
752	Graduated cylinder class AS	50 ml	2	0.163	0.0027
753	Graduated cylinder class AS	100 ml	2	0.194	0.0023
754	Graduated cylinder class AS	250 ml	2	0.521	0.0053
755	Graduated cylinder class AS	500 ml	1	0.546	0.0057
756	Graduated cylinder class AS	1000 ml	1	0.870	0.0095



## Glass Pasteur pipettes with open an closed tip

In neutral soda glass, closed at the tip and with cotton in the mouth.  
The opening of the closed part is simple, by lightly pressing with the fingers.

Open tip measurements:  
Ø of the mouth:  $6.95 \pm 0.15$  mm  
Ø tip:  $1.2 \pm 0.15$  mm  
thickness:  $0.53 \pm 0.03$  mm

Closed tip measurements:  
Ø of the mouth: 7.0 mm  
Ø of the tip: 1.4 to 1.6 mm  
thickness: 0.50 mm



code	total length mm	stem length mm	case quantity	case weight	case volume
<b>Open tips</b>					
701	150	59	4 x 250	3.33	0.012
702	230	130	4 x 250	3.50	0.018
<b>Closed tips</b>					
712	230	130	4 x 250	3.68	0.014



## Graduated pipette

Graduated pipettes made of Soda-lime standard glass with serial certificate per piece. Pour-adjusted (Ex).

Graduated pipettes, class AS, are manufactured with a 5s hold time, pour-adjusted (EX + 5s) with colour-coded identification card.

Produced in accordance with ISO 835 standards.

Available with Schellbach stripe for better reading accuracy.  
Calibration certificate accredited to ISO 17025, on request.



code	description	capacity ml	quantity	weight	volume
725	Graduated pipette class AS	1 ml	5	0.166	0.0010
726	Graduated pipette class AS	2 ml	5	0.154	0.0010
727	Graduated pipette class AS	5 ml	5	0.154	0.0010
728	Graduated pipette class AS	10 ml	5	0.178	0.0011
729	Graduated pipette class AS	25 ml	5	0.278	0.0011



## Pipettes with 1 or 2 marks

Pipettes with 1 or 2 calibrations marks made of Soda-lime standard glass and with serial certificate per piece.

Class AS, manufactured with a 5s waiting time, adjusted by pouring (EX + 5s).

With colour-coded identification bands, according to ISO 1769.

Calibration certificate accredited to ISO 17025, on request.

Produced in accordance with ISO 648 standards.



code	description	capacity ml	quantity	weight	volume
715	Pipette 1 mark class AS	1 ml	5	0.157	0.0010
716	Pipette 1 mark class AS	2 ml	5	0.164	0.0010
717	Pipette 1 mark class AS	5 ml	5	0.170	0.0010
718	Pipette 1 mark class AS	10 ml	5	0.209	0.0010
719	Pipette 1 mark class AS	25 ml	5	0.238	0.0013
720	Pipette 2 marks class AS	1 ml	5	0.166	0.0010
721	Pipette 2 marks class AS	2 ml	5	0.154	0.0010
722	Pipette 2 marks class AS	5 ml	5	0.154	0.0010
723	Pipette 2 marks class AS	10 ml	5	0.178	0.0011
724	Pipette 2 marks class AS	25 ml	5	0.278	0.0011



## Bottles for sterilization

Made of soda glass 3.3. **Autoclavable** up to **140 °C**.  
 Graduations printed in white colour. Screw caps (GL45) made of blue polypropylene.  
 Ribbed screw caps for a better handling. Drip ring on bottle neck to avoid dripping. Ideal for chemical reagents and culture media.  
 They can be used to freeze substances up to **-40 °C**.  
 It is recommended to freeze them in an inclined position (ca 45°) and filled up to max. 3/4.

Produced in accordance with ISO 4796 standards.



code	capac. ml	screw	Ø ext. mm	height mm	case quantity	case weight	case volume
402001	100	GL45	56	100	10	1.80	0.004
402002	250	GL45	70	138	10	2.79	0.008
402005	500	GL45	86	176	10	4.22	0.015
402010	1,000	GL45	101	225	10	6.52	0.027
402020	2,000	GL45	136	260	10	10.54	0.059



## Graduated beakers low form

Low-form graduated beakers made of borosilicate glass 3.3 and under ISO 3819 standard.  
 With spout for better pouring.



code	description	capacity ml	quantity	weight	volume
730	Graduated beakers	25 ml	20	0.535	0.0023
731	Graduated beakers	50 ml	10	0.403	0.0029
732	Graduated beakers	100 ml	10	0.596	0.0044
733	Graduated beakers	150 ml	10	0.807	0.0045
734	Graduated beakers	250 ml	10	1.162	0.0111
735	Graduated beakers	400 ml	10	1.655	0.0123
736	Graduated beakers	600 ml	10	2.267	0.0123
737	Graduated beakers	1000 ml	10	3.380	0.0273
738	Graduated beakers	2000 ml	4	2.035	0.0273
739	Graduated beakers	3000 ml	4	3.109	0.0273





# 11. LABORATORY AND INDUSTRIAL PACKAGING





## Polyethylene wide mouth jars with lid and insert plug

Cylindrical jars made of **high-density polyethylene**, with a ribbed screw-on lid and stopper. Body and stopper in translucent natural colour and standard black lid. Supplied unthreaded (except for sterile models, which are supplied covered and bagged).

Sterilised under minimum order of 6 boxes per model. Sterile by radiation (sterile models).

Made of materials suitable for food use.



code	capacity ml	sterile, individual wrap	no sterile, individual wrap	Ø internal mouth mm	Ø body mm	unitary weight g	height with lid mm	case quantity	case weight	case volume	pallet quantity
202810	60	—	—	38	52	8.2	48	200	3.90	0.046	8,000
202809.E	125	—	—	51	60	12	62	200	6.00	0.082	4,000
202802	250	—	—	54	67	20	100	125	4.85	0.080	2,500
202802.1	250	yes	yes	54	67	20	100	125	4.94	0.084	2,500
202802B	250	—	yes	54	67	20	100	125	5.50	0.078	2,500
202814	400	—	—	60	74	27.3	124	130	8.00	0.140	1,560
202814.1	400	yes	yes	60	74	27.3	124	130	8.00	0.140	1,560
202803	500	—	—	67	80	35	131	120	7.70	0.140	1,920
202823.1	500	yes	yes	67	80	35	131	120	7.60	0.140	1,920



code	capacity ml	sterile, individual wrap	no sterile, individual wrap	Ø internal mouth mm	Ø body mm	unitary weight g	height with lid mm	case quantity	case weight	case volume	pallet quantity
202821E.1	500	—	yes	86	103	44.9	93	144	8.31	0.140	1,520
202821E	500	—	—	86	103	44.9	93	144	8.44	0.140	1,520
202821E.3	500	yes	yes	86	103	44.9	93	144	9.20	0.140	1,520
202823	500	—	yes	67	80	35	131	120	8.60	0.130	1,920
202813	750	—	—	86	103	48	127	75	4.56	0.152	900
202813.10	750	yes	yes	86	103	48	127	75	7.20	0.140	1,200
202818	1,000	—	—	86	103	56.7	157	50	5.43	0.140	800
202828G	1,000	yes	yes	86	103	56.7	157	50	5.66	0.140	800
202828	1,000	—	yes	86	103	56.7	157	50	5.66	0.140	800
202815	1,550	—	—	86	113	64.6	181	45	6.00	0.140	720
202815B.0	1,550	yes	yes	86	113	64.6	181	45	6.00	0.140	720
202820	2,000	—	—	86	103	83.1	283	35	5.12	0.140	560
202820.0	2,000	yes	yes	86	103	83.1	283	35	6.10	0.140	560
202839*	2,000	—	—	105	128	73	205	32	5.14	0.140	512

\* This model is supplied with lid.

Please consult minimum order and delivery time for other body or lid colours. They can also be supplied in individual bags.



## Polyethylene beakers

Volumes available range from 60 ml to 1,000 ml.

All models come without lid, except the 1,000 ml beaker, which is available with or without lid.

For use with liquid and solid samples. Manufactured in a flexible material for easy pouring.

code	volume ml	body Ø mm	mouth Ø mm	height mm	weight body g	case quantity	case weight	case volume
242803	230	55	70	78	15.5	700	10.82	0.042
242806	1,000	90	120	132	65.0	120	8.22	0.042
242811*	1,000	90	120	132	65.0	65	5.93	0.042

\* With lid, Beaker and lid are supplied in the same bag,



## Disposable cups

Disposable sample cups, for general sample collection.

Cups are supplied stacked.



code	volume ml	material	mouth Ø x height	case quantity	case weight	case volume
202248	100	polypropylene	57.5 x 62	48 x 100	5.53	0.070
202317	150	polystyrene	70 x 70	30 x 100	8.32	0.080



## Tamper evident buckets, large capacity

Disposable containers made of **autoclavable polypropylene**. Include tight fitting and leakproof lids. All models include a sturdy and convenient white plastic handle for easier carrying. Buckets are supplied with lid apart. **Made with materials suitable for food use.**



code	capacity l	Ø ext. lid mm	Ø int. mouth mm	height whitout lid mm	*body weight g	case quantity	case weight	case volume
222802	3	200	184	138	105	80	9.00	0.140
222803	4.5	225	210	156	134	48	10.46	0.140
222804	5.6	225	211	194	152	45	10.79	0.140
222805	10.6	268	251	265	265	20	8.39	0.140

\* Weight with no lid.



## Jars with lid

Body and lid in white **autoclavable polypropylene**.

Self sealing security lid.

Code **241013**, **241014** and **241015** embody a plastic handle.

Jars are supplied uncapped.

Cases per pallet: 24, excepting code **241010**, palletized in 40 cases.

**Made with materials suitable for food use.**



code	nominal cap. ml	Ø int. mouth x Ø base x h without lid mm	*weight g	case quantity	case weight	case volume
241010	250	84 x 79 x 61	13	150	3.04	0.042
241011	550	107 x 98 x 79	24	250	5.01	0.103
241013	1,000	107 x 94 x 144	32	150	7.31	0.082
241014	1,560	135 x 118 x 138	48	150	10.12	0.130
241015	2,000	163 x 144 x 156	72	48	5.37	0.075

\* Weight with no lid.



## Buckets with spout

Natural **low density polyethylene** buckets with a stainless metal handle. Include a spout for easier pouring.

Moulded-in graduations. Very sturdy construction.

These buckets may be printed with your name and logo.



code	capacity l	dimensions mm	quantity	weight	volume
19905	9	270 x 200 x 250	1	0.58	0.014
19906	12	300 x 220 x 280	1	0.70	0.018
19907	15	340 x 250 x 310	1	0.85	0.026



## Industrial jugs

Made of thick **rigid polypropylene**. Natural colour.

Recommended for industrial use.

code	capacity l	mouth Ø mm	height mm	weight ut. g	case quantity	case weight	case volume
470007	5	190	240	400	5	1.86	0.030

## Round jugs with handle

Polypropylene. **Autoclavable to 121 °C**. Moulded-in graduations



code	capacity l	graduation ml	Ø mm	height mm	case quantity	case weight	case volume
470000	0.5	25	80	120	60	4.40	0.066
470001	1	50	125	140	48	4.60	0.086
470002	2	50	155	180	36	6.40	0.110
470003	3	100	165	180	27	7.10	0.130
470005	5	250	185	230	12	5.00	0.106

Minimum order quantity: 1.



## Self sealing security jars

High-quality workmanship, body in **autoclavable polypropylene**. Screw cap in high density polyethylene with strips. Security sealing with tag for easy opening. Tamper evident system. External moulded ring. Smooth internal side. Each jar specifies on its bottom its capacity, and the material it is made of. Supplied uncapped. **Made with materials suitable for food use.**



code	volume ml	max. body Ø mm	base Ø mm	height Ø mm	lid external Ø mm	weight ut. without lid g	case quantity	case weight	case volume
202911N	100	55.8	50.0	59.1	56.0	15.0	150	3.40	0.042
202912N	250	71.8	65.0	83.4	72.0	23.3	115	4.80	0.082
202913N	350	94	87.7	68.0	96.0	27.0	80	3.64	0.082
202914N	500	94	87.7	105.3	96.0	36.0	100	6.15	0.140
202915N	1,000	111.6	110.8	123.8	111.8	62.0	60	7.13	0.140
202916N	1,250	111.6	110.8	153.0	111.8	73.0	45	5.32	0.140



## Square containers with star-shaped caps

Colour: translucent white. Containers and insert plugs made of **polyethylene**. Star-shaped screw caps made of polypropylene. Tagging points on neck and cap for a tamper proof closure or for labeling. All models have moulded-in graduations. Containers are supplied plugged and capped. Not recommended for liquids transport.

**Made with materials suitable for food use.**



code	capacity ml	graduation each ml	dimensions mm	neck Ø mm	body weight g	case quantity	case weight	case volume	pallet quantity
444608	25	12.5	32 x 34 x 52	18	6	500	6.60	0.090	12,000
444609	50	10	38 x 38 x 70	23	15	400	7.50	0.074	9,600
444610	100	20	42 x 48 x 90	33	22	600	18.20	0.195	9,600
444611	250	50	57 x 60 x 110	33	32	300	13.80	0.195	4,800
444612	500	100	70 x 80 x 138	44	55	150	10.50	0.192	2,400
444613	1,000	100	80 x 103 x 176	58	97	80	11.16	0.173	1,280
444614	2,000	100	100 x 134 x 210	58	177	40	9.16	0.170	640



### Bottles with standard, narrow neck

Bottles made of **autoclavable**, natural colour **polypropylene**. Hermetical closure. Easy opening and closing caps thanks to its size. Grippled, in order to ease its usage with gloves. Cap and body with holes for sealing or labeling. Neck and cap with vents. Graduation: 100 ml model, every 20 ml and 1,000 ml every 100 ml.



code	volume ml	neck DIN	mouth Ø mm	body Ø mm	height mm	body weight g	case quantity	case weight	case volume
191597	100	GL18	13	48	106	18.5	100	1.82	0.032
191603	1,000	GL32	23	95	222	100.9	80	8.80	0.180

### Bottles with standard, wide neck

Wide neck bottles made of **autoclavable polypropylene**, or **polyethylene** (not autoclavable).

Body and caps in natural colour. Hermetical closure.

Easy opening and closing caps thanks to its size. Grippled, in order to ease its usage with gloves.

Neck and cap with vents. Graduation: 100 ml model, every 20 ml; 250 ml, every 25 ml; 500 ml, 1,000 ml, and 2,000 ml, every 100 ml.



Made of polyethylene, not autoclavable:

code	volume ml	neck DIN	mouth Ø mm	body Ø mm	height mm	body weight g	case quantity	case weight	case volume
191610	100	GL32	24	48	103	25.7	100	2.78	0.036
191612	250	GL45	38	60	140	39.2	5 x 50	2.06	0.180
191614	500	GL45	38	75	168	55.9	5 x 25	9.30	0.180
191616	1,000	GL63	55	95	206	109.3	68	9.30	0.180
191618	2,000	GL63	55	120	249	145.2	30	6.30	0.180



Made of polypropylene, autoclavable:

code	volume ml	neck DIN	mouth Ø mm	body Ø mm	height mm	body weight g	case quantity	case weight	case volume
191623	100	GL32	24	48	103	26.6	100	2.98	0.038
191625	250	GL45	38	60	140	40.8	250	12.40	0.180
191627	500	GL45	38	75	168	56.5	125	8.50	0.180
191629	1,000	GL63	55	95	206	100.2	68	8.84	0.180
191631	2,000	GL63	55	120	249	175.5	30	6.30	0.180



## Wide neck graduated containers with star-shaped cap

Colour: translucent white.

Bottles and insert plugs made of **high density polyethylene**.

Star-shaped screw caps made of polypropylene.

Tagging points on neck and cap for a tamper proof closure.

Sloping shoulders for easy pouring.

Bottles are supplied plugged and capped.



code	volume ml	graduation ml	internal mouth Ø mm	body Ø mm	height mm	body weight g	case quantity	case weight	case volume	pallet quantity
19408	50	10	24	40	75	13.20	100	1.65	0.019	9,600
19409	100	20	24	50	90	18.30	100	2.37	0.027	8,400
19410	250	25	34	60	125	35.80	50	2.16	0.037	3,600
19411	500	50	34	75	160	50.70	20	1.20	0.024	1,120
19412	1,000	100	45	95	200	92.20	20	1.95	0.046	960







### Graduated narrow neck bottles

Made of translucent **polyethylene**.

Designed for the storage of acids and bases. Include a ribbed screw cap for a better handling, and an insert plug.

Feature sloping shoulders for easy pouring.

Tagging points on neck and cap for a tamper proof closure and for labeling.

Bottles have the following moulded-in graduations: code **19317**, every 10 ml; **19319**, every 20 ml; **19323**, every 25 ml, **19324**, every 50 ml, **19325** and **19326**, every 100 ml.

Supplied capped.



code	volume ml	neck Ø mm	bottom Ø mm	height mm	case quantity	case weight	case volume
<b>19319</b>	125	18.5	46	107	6 x 100	15.48	0.151
<b>19323</b>	250	23	60	131	6 x 50	12.78	0.151
<b>19324</b>	500	23	74	157	6 x 25	9.00	0.195
<b>19325</b>	1,000	33	94	205	4 x 20	9.00	0.187
<b>19326</b>	2,000	33	112	266	2 x 20	8.40	0.151



### Graduated narrow neck opaque bottles

Opaque cylindrical bottles made of **dark grey polyethylene**, designed for the storage of light sensitive liquids or solid substances. Include a black screw cap and an insert plug for a positive leakproof seal.

Ribbed caps for a better handling.

Heavy duty bottles, with sloping shoulders for easy pouring.

Tagging points on neck and cap for a tamper proof closure.

Body and cap with holes for sealing or labeling. Supplied capped.

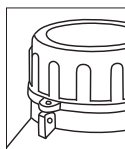

code	volume ml	neck Ø mm	bottom Ø mm	height uncapped mm	case quantity	case weight	case volume
<b>193241</b>	500	23	75	157	6 x 25	9.00	0.195
<b>193251</b>	1,000	33	95	208	4 x 20	9.70	0.192

Minimum order quantity: 1 bag.

### Narrow neck, high resistance bottles

Bottles made of translucent, white, **high density polyethylene**, designed for the storage of acids and bases.

Blue screw cap on a combination of high and low density polyethylene. Screw caps are ribbed for a better handling.

Sloping shoulders for easy pouring. Heavy duty bottles.

Supplied uncapped.



See page 249

code	volume ml	neck Ø mm	bottom Ø mm	height mm	case quantity	case weight	case volume
<b>44270000</b>	500	30	79	176	70	4.86	0.076
<b>44280000</b>	1,000	30	96	211	50	6.70	0.110



## Tamper evident, polyethylene bottles

Translucent cylindrical bottles made of **high density polyethylene with PP screw cap** and LDPE insert plug, designed for the storage of alcohol. Caps are ribbed for a better handling while working with gloves. Insert plugs are dispensed pierced. Tamper evident cap. No graduation. Supplied uncapped.



code	capac. ml	int. neck Ø mm	bottom Ø mm	height mm	body weight g	case quantity	case weight	case volume	pallet quantity
14	125	19	45	106	10	140	2.44	0.043	5,600
24	250	19	58	128	18	80	2.10	0.044	3,200
34	500	19	73	160	31	100	4.30	0.107	1,200
44	1,000	19	82	230	46	60	5.00	0.110	720



## Tamper evident bottles, tall models

Translucent cylindrical bottles made of natural colour **low density polyethylene**, with red tamper evident closures. Caps are ribbed for a better handling while working with gloves. Bottles specially designed with tamper evident rings to ensure a positive seal. Bottles are supplied uncapped. To fully seal them, screw cap in a normal way and then screw again to fully position the tamper evident ring. To open, unscrew cap. The ring, automatically broken, will remain on the neck of the bottle.

code	capac. ml	body Ø mm	neck Ø mm	height mm	body weight g	case quantity	case weight	case volume	pallet quantity
282305	500	66	37	200	35.0	100	4.98	0.100	1,600
282306	1,000	87	37	230	52.0	60	4.22	0.140	960



## Screw cap containers with seal and dropper

Made of **white polypropylene**. White watertight screw closing system with dropper-plug and blue security seal. Hermetical closure. Mouth diameter: 10.2 mm. Supplied uncapped.

code	volume ml	Ø base mm	height mm	body weight g	case quantity	case weight	case volume	pallet quantity
53020	20	24.6	65	3.50	2,000	12.70	0.122	32,000
53125	125	42.2	134.7	15.50	275	5.88	0.114	4,400
53250	250	50.8	167.3	21.50	200	5.95	0.100	3,200



## Rectangular bottles

Body and cap made of **polyethylene**.

Bottles with blue screw caps, including seal ring and internal joint.

Tamper evident system.

Body in natural colour, graduated (moulded):

250 ml model, graduated each 50 ml.

500 and 1,000 ml models, graduated each 100 ml.

Supplied uncapped.



code	volume ml	internal mouth Ø mm	dimensions (A x B x C) mm	weight g	case quantity	case weight	case volume	pallet quantity
292819G	250	30.3	58 x 58 x 115	21	175	5.90	0.096	3,360
292820G	500	30.8	87.5 x 67 x 131.5	35	153	9.70	0.140	2,448
292821G	1,000	30.8	88.5 x 67 x 228	62	82	6.41	0.140	1,360



## Nozzle bottles

Cylindrical bottles with screw caps, made of **high density polyethylene**, with a narrow nozzle design. Natural colour.

Cut the nozzle tip with scissors before liquid dispensing.

No graduation.

Bottles and caps are supplied in separated bags.



code	volume ml	neck Ø mm	bottom Ø mm	height mm	case quantity	case weight	case volume
272301	50	20	35	75	160	2.10	0.027
272303	125	20	48	100	135	2.52	0.045
272304	250	20	59	143	75	2.24	0.047



## Squared bottles

Bottles with screw cap and insert plug, made of **polyethylene**.  
 Bottles and insert plugs are white (translucent), caps are red.  
 Ribbed caps for a better handling when using gloves.  
 Supplied capped.

code	volume ml	mouth Ø mm	dimensions mm	weight g	case quantity	case weight	case volume	pallet quantity
292819	250	37	58 x 58 x 103	21	210	6.00	0.096	3,360
292820	500	50.5	77 x 77 x 116	35	165	8.18	0.140	2,640
292821	1,000	50.5	96 x 75 x 172	62	96	7.55	0.140	1,536





### Drum with screen and childproof cap

Made of white colour **high density polyethylene**.

They embody a handle and a graduated screen which allows the user to see the content.

**Childproof, tamper evident**, ribbed screw cap with insert plug.

Drums are supplied non screwed.

**Dimensions:** 132.5 x 187 x 290 mm

**Made with suitable for food use and ADR approval.**

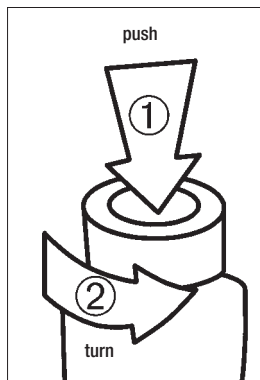

code	capacity l	total cap. ml	Ø int. mouth mm	body weight g	case quantity	case weight	case volume	pallet quantity
202505	5	5,380	40	190	16	3.25	0.14	256

### Cylinder with handle

Made of **polypropylene**. **Autoclavable at 121 °C**.

The handle provides a secure, solid grip for superior control, specially when handling large volumes.

Pouring is safer and more convenient, as the cylinder is specially designed to ensure a total liquid delivering. 89 x 29 mm hand opening for easy handling.

Hexagonal base to prevent tipping and rolling.

Accurate and easy to read graduated double scale on the cylinder.



code	volume l	graduation ml	height mm	bottom Ø mm	Ø cylinder int. mm	Ø cylinder ext. mm	quantity	weight	volume
191578	1	10	440	146	59	64	1	0.62	0.020
191579	2	20	490	161	81	87	1	0.56	0.020



## Stackable drums with tamper evident caps

Made of natural colour **high density polyethylene**. They embody a **handle** and a **tamper evident**, ribbed screw red **cap**, made of HDPE, with internal joint and internal security ring.

Hermetical closure when the cap is totally screwed.

**ONU ADR** compliant. Drums and caps are supplied non screwed.



code	capacity l	total capacity ml	minimum wall thickness mm	dimensions mm	quantity	weight	volume	pallet quantity
206020	20	20,900	1.20	242 x 298 x 365	1	1.00	0.023	48
206025	25	25,550	1.20	242 x 298 x 443	1	1.14	0.028	48



## Wide mouth drums with security cap

Body made of natural colour and translucent **polyethylene**.

Cap made of blue polyethylene. Cap with seal and internal joint.

It incorporates a black plastic handle.

Suitable for solids and semi-solids.



code	capacity l	Ø external body mm	Ø internal mouth mm	height mm	quantity	weight	volume	pallet quantity
202705	5	168	97	288	11	3.65	0.133	176
202710	10	210	97	353	6	3.24	0.134	96





### Drums with tap

Made of **high density polyethylene**. (Code **19375** is made of polypropylene). Heavy duty drums, wall thickness 2 mm. With two handles for easy transport. Can be used at temperatures below 0 °C. The tap includes a seal ring to ensure a leakproof seal. Drums are supplied complete with tap (also available spare tap). Each drum includes a screw cap and a plug for added security. **Be sure to tighten the drums' thread firmly.**

code	capacity l	Ø neck mm	Ø base mm	height mm	quantity	food use	weight	volume
19660	5	52.5	165	345	1	✓	0.85	0.019
19662	10	52.5	210	425	1	✓	0.50	0.016
19664*	25	79.5	280	565	4		5.76	0.17
19666*	50	79.5	350	700	2		4.80	0.17

#### Spare tap:

19375	-	-	-	-	1		0.005	0.0001
-------	---	---	---	---	---	--	-------	--------

\*Minimum order quantity: 1.

### Wide and narrow neck drums

Heavy duty drums made of **high density polyethylene**. The intended use of these drums is the storage of solids and powders, not for liquids due to their **non-hermetic closure**. Handle for greater comfort when transporting it.

Made with **materials suitable for food use**.



#### Wide neck bottles:

code	capacity l	Ø neck mm	Ø body mm	height mm	quantity	weight	volume	pallet quantity
191640	5	94	170	340	1	0.43	0.009	200
191642	10	108	210	415	1	0.90	0.014	90



#### Narrow neck bottles:

code	capacity l	Ø neck mm	Ø body mm	height mm	quantity	weight	volume	pallet quantity
191646	10	52.5	210	425	1	0.90	0.014	90



## Stackable drum with tamper evident screw cap

Made of **high density polyethylene**.

It is provided with a sealing screw cap with grip.

This drum has four flat sides suitable for sticking information labels.

They are differentiated by two main characteristics: they can be easily stacked joining the tops and the bottoms together, and they can be palletised thanks to their reduced overall dimensions.

All of them are **ONU ADR** compliant, meeting all the standards for the transport of hazardous, toxic and noxious products.

**Made with materials suitable for food use.**



code	nominal capacity l	total capacity l	dimensions mm	Ø mouth mm	DIN	quantity	weight	volume	pallet quantity
202605	5	5.5	198 x 148 x 240	44	51	1	0.27	0.007	200
202610	10	11.6	224 x 193 x 305	44	51	1	0.47	0.017	100
<b>NEW</b> 202620N	20	21.8	295 x 243 x 385	44	51	1	0.79	0.027	48
202625	25	26.9	245 x 295 x 435	44	51	1	1.10	0.031	48
202630	30	34.5	332 x 290 x 428	49	61	1	1.26	0.036	36





## Wide mouth storage drums with tap and plug

Body and cap made of **polyethylene**. Screw cap with non hermetical plug. Using Teflon at thread tap is recommended to ensure a complete sealing. They embody a tap, and two black folding handles at the top. Not designed to transport liquids. External mouth diameter: 150 mm.

code	capacity l	Ø base mm	height mm	quantity	weight kg	volume
209030	30	355	457	1	1.51	0.059
209050	50	355	675	1	2.35	0.084



## Large deep trays

Made of natural **high density polyethylene**. Stackable. Include ergonomically designed handles.



code	dimensions mm	height mm	tray volume l	quantity	weight kg	volume
19603	550 x 430	310	50	1	1.76	0.069
19604	630 x 440	340	65	1	3.00	0.090
19605	720 x 470	360	90	1	4.50	0.120

## Funnels

Material: **polypropylene**. Autoclavable.



code	external Ø mm	internal Ø mm	exit Ø (mm)	length (mm)	stem length (mm)	quantity	weight	volume
194171	80	75	5	83	30	1	0.03	0.0001
194172	100	90	8	100	35	1	0.03	0.0005
194175	180	175	12	170	60	1	0.09	0.0013
194176	220	210	17	205	75	1	0.17	0.0028
194177	260	250	21	245	85	1	0.29	0.0081
194178	300	290	24	285	105	1	0.37	0.0110



## Industrial drums

These drums are produced in **high density polyethylene**. Their particular top, which has a **perfectly stiffened rim obtained** during the moulding phase, prevents the opening from becoming deformed and the lid from becoming detached as a consequence of any drops or violent shocks.

They feature a metal washer that ensures a perfect closure also suitable to place a tamper evident seal.

Thanks to their **airtight seal**, they are **suitable for transport by sea, road or railway** and, thanks to their construction characteristics and qualities; they **fully meet the current ONU ADR standards for transport of hazardous products**.

Incinerable (excluding the metal closure).

These drums are produced using selected top-quality raw materials, they feature excellent drop-impact resistance even at low temperature (−20 °C) and stability against corrosion from chemical agents which may cause stress cracking.

Their **internal surface is perfectly smooth**, and this makes it easy to fully empty and completely clean the inside from any powder, paste or semi-dense products. All references have two handles for easy carrying except code **208128**.

code	capacity l	external body Ø mm	external mouth Ø mm	internal mouth Ø mm	height mm	food use	quantity	weight kg	volume	pallet quantity
<b>CYLINDRICAL DRUMS</b>										
208030	30	320	252	255	502	✓	1	2.50	0.08	48
208060	60	405	327	400	610	✓	1	3.02	0.15	27
208128	120	480	400	390	800	✓	1	5.48	0.30	18
<b>RECTANGULAR DRUMS</b>										
208031	30	285	275	235	52	✓	1	1.89	0.033	100
208061	60	360	445	423	62	✓	1	2.99	0.078	48



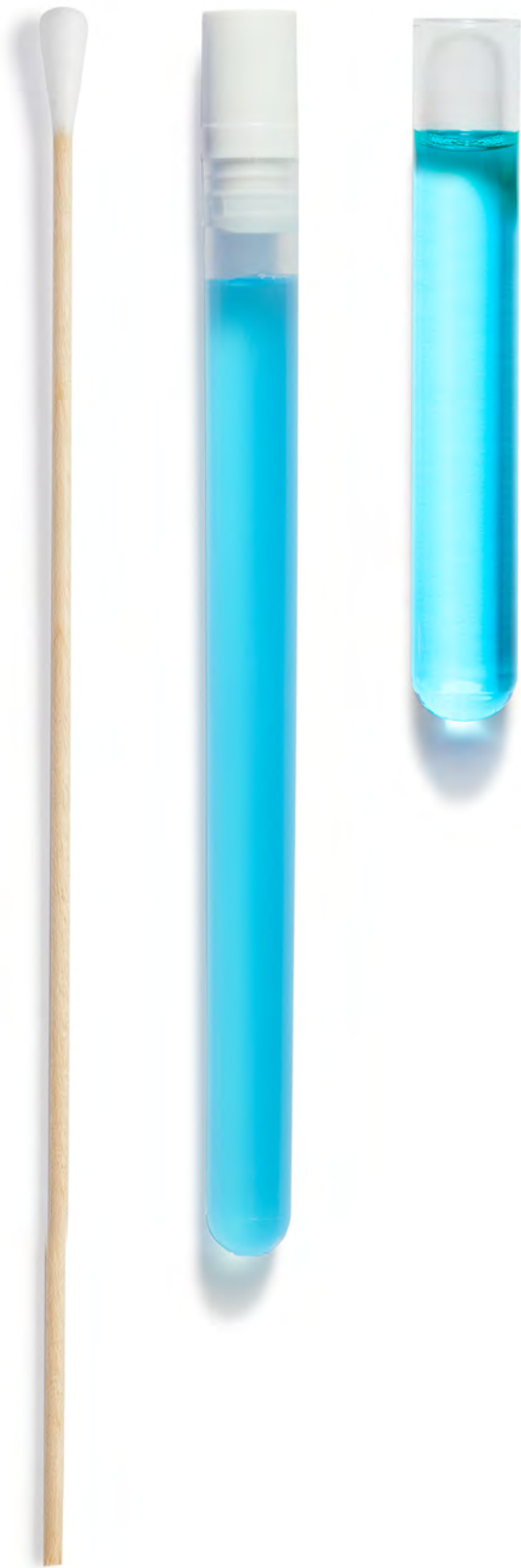

# 12. TECHNICAL INFORMATION AND INDEXES



## CHEMICAL RESISTANCES

	PELD		PEHD		PP		PS		TPX		ABS		PMMA		PC		PVC		PTFE	
°C	20	50	20	50	20	50	20	50	20	50	20	50	20	50	20	50	20	50	20	50
1.4 - dioxane	▲	■	▲	▲	■	■	●	●	■	■			●	●	■	■	●	●	▲	▲
Acetaldehyde	▲	●	▲	■	▲	●	●	●	▲	●	●	●	●	●	■	●	■	●	▲	▲
Acetic acid	▲	▲	▲	▲	▲	▲	■	■	▲	▲	●	●	●	●	▲	■	▲	■	▲	▲
Acetone	■	●	▲	▲	▲	▲	●	●	▲	▲	■	■	●	●	●	●	●	●	▲	▲
Acrylonitrile	▲	▲	▲	▲	■	●	●	●	●	●			●	●	●	●	●	●	▲	▲
Adipic acid	▲	▲	▲	▲	▲	▲	▲	▲	▲	▲			▲	▲	▲	▲	▲	■	▲	▲
Aluminium chloride	▲	▲	▲	▲	▲	▲	▲	▲	▲	▲			▲	▲	●	●	▲	■	▲	▲
Aluminium hydroxide	▲	▲	▲	▲	▲	▲	■	■	▲	■			■	■	■	●	▲	▲	▲	▲
Allyl alcohol	▲	▲	▲	▲	▲	▲	▲	■	▲	■			●	●	▲	■	■	●	▲	▲
Amino acids	▲	▲	▲	▲	▲	▲	▲	▲	▲	▲					▲	▲	▲	▲	▲	▲
Ammoniac	▲	▲	▲	▲	▲	▲	■	●	▲	▲			▲	▲	●	●	■	■	▲	▲
Ammonic hydroxide (30 %)	▲	▲	▲	▲	▲	▲	■	●	▲	▲	▲	■	▲	▲	●	●	▲	■	▲	▲
Ammonium chloride	▲	▲	▲	▲	▲	▲	▲	▲	▲	▲	▲	▲	■	■	■	■	▲	■	▲	▲
Amyl acetate	■	●	▲	■	■	●	●	●	▲	■			▲	▲	●	●	●	●	▲	▲
Amyl alcohol	▲	▲	▲	▲	▲	▲	■	■	▲	▲					▲	▲	■	■	▲	▲
Amyl chloride	●	●	●	●	●	●	●	●	●	●			●	●	●	●	●	●	▲	▲
Aniline	▲	■	▲	▲	▲	▲	●	●	▲	■	●	●	●	●	■	●	●	●	▲	▲
Aqua regia	●	●	●	●	■	●	■	●	■	■	●	●	●	●	●	●	■	■	▲	▲
Benzaldehyde	▲	▲	▲	▲	▲	▲	●	●	▲	▲	●	●	●	●	■	●	●	●	▲	▲
Benzene	■	●	▲	▲	▲	■	●	●	▲	■	●	●	●	●	●	●	●	●	▲	▲
Benzine	■	●	▲	▲	■	■	●	●	▲	■			▲	▲	■	●	▲	▲	▲	▲
Benzoid acid	●	●	●	●	●	●	●	●	●	●			●	●	■	■	■	■	▲	▲
Boric acid (10 %)	▲	▲	▲	▲	▲	▲	▲	▲	▲	▲	▲	▲	▲	▲	▲	▲	▲	▲	▲	▲
Bromine	●	●	●	●	●	●	●	●	●	●			●	●	●	●	●	●	▲	▲
Bromoform	●	●	●	●	●	●	●	●	●	●			●	●	●	●	●	●	▲	▲
Butyl acetate	■	■	▲	▲	■	■	●	●	▲	■	●	●	●	●	●	●	●	●	▲	▲
Butyl alcohol	▲	▲	▲	▲	▲	▲	■	●	▲	■	●	●	■	●	■	■	■	■	▲	▲
Calcium chloride	▲	▲	▲	▲	▲	▲	▲	▲	▲	▲			▲	▲	▲	▲	■	●	▲	▲
Calcium hydroxide	▲	▲	▲	▲	▲	▲	▲	■	▲	▲			▲	▲	●	●	▲	▲	▲	▲
Calcium hypochlorit	▲	▲	▲	▲	▲	▲	▲	▲	▲	■			■	■	■	●	■	●	▲	▲
Carbon sulphate	●	●	●	●	●	●	●	●	●	●			●	●	●	●	●	●	▲	▲
Carbon tetrachloride	●	●	■	●	●	●	●	●	●	●			■	●	●	●	●	●	▲	▲
Citric acid	▲	▲	▲	▲	▲	▲	▲	■	▲	▲	▲	▲			▲	■	■	■	▲	▲
Cupric sulphate	▲	▲	▲	▲	▲	▲	▲	▲	▲	▲			▲	▲	▲	▲	▲	■	▲	▲
Chlorine (10 %)	■	●	■	●	■	●	●	●	■	●			■	●	■	■	■	●	▲	▲
Chlorine water	●	●	●	●	●	●	●	●	■	●	▲	▲	●	●	●	●	●	●	▲	▲
Chloroform	●	●	▲	■	●	●	●	●	■	●	●	●	●	●	●	●	●	●	▲	▲
Chlorydic acid (35 %)	▲	▲	▲	▲	▲	▲	■	■	▲	▲			■	●	●	●	■	●	▲	▲
Chromic acid (10 %)	▲	▲	▲	▲	▲	▲	■	■	▲	▲			■	●	▲	■	▲	■	▲	▲
Chromic acid (50 %)	▲	■	▲	■	■	■	●	●	■	■			●	●	■	●	▲	●	▲	▲
Chromic sulphate blend	▲	●	▲	●	●	●	■	■	■	●			●	●	●	●	▲	■	▲	▲
Decahydronaphthalene	■	■	■	■	●	●	●	●	■	●			●	●	●	●	▲	■	▲	▲
Dichlorobenzene	■	●	■	●	■	●	●	●	●	●	●	●	●	●	●	●	●	●	▲	▲
Diethylene glycol	▲	▲	▲	▲	▲	▲	■	●	▲	▲			●	●	■	■	●	●	▲	▲
Dimethyl formamide	▲	▲	▲	▲	▲	▲	●	●	▲	▲			●	●	●	●	■	●	▲	▲
Dimethyl sulphoxide	▲	▲	▲	▲	▲	▲	●	●	▲	▲			●	●	●	●	●	●	▲	▲
Ether	●	●	■	●	■	●	●	●	●	●	●	●	●	●	●	●	●	●	▲	▲
Ethyl acetate	▲	▲	▲	▲	▲	▲	●	●	▲	■	●	●			●	●	●	●	▲	▲
Ethyl alcohol (100%)	▲	▲	▲	▲	▲	▲	●	●	▲	■	■	■	●	●	▲	■	▲	■	▲	▲
Ethylene chloride	●	●	●	●	■	●	●	●	●	●	●	●	●	●	●	●	●	●	▲	▲
Ethylene oxide	■	■	■	■	■	●	●	●	■	●			●	●	■	●	■	●	▲	▲
Fluorine	●	●	●	●	●	●	●	●	■	●			●	●	■	■	▲	▲	▲	▲
Formaldehyde (40 %)	▲	▲	▲	▲	▲	▲	●	●	▲	▲	■	●	●	●	▲	■	■	●	▲	▲
Formic acid (98-100 %)	▲	▲	▲	▲	▲	▲	▲	■	▲	▲	■	■	●	●	▲	■	●	●	▲	▲
Fuel oil	■	●	▲	■	▲	▲	●	●	■	■			■	●	▲	■	●	●	▲	▲

°C	PELD		PEHD		PP		PS		TPX		ABS		PMMA		PC		PVC		PTFE	
	20	50	20	50	20	50	20	50	20	50	20	50	20	50	20	50	20	50	20	50
Hexane	●	●	▲	■	▲	■	■	●	■	●	●	●	▲	▲	●	●	■	●	▲	▲
Hydrofluoric acid (40 %)	▲	▲	▲	▲	▲	▲	▲	▲	▲	▲			●	●	●	●	■	●	▲	▲
Hydrofluoric acid (70 %)	▲	●	▲	■	▲	■	●	●	▲	■			●	●	●	●	●	●	▲	▲
Hydrogen peroxide (35%)	▲	▲	▲	▲	▲	▲	▲	▲	▲	▲	●	●	●	●	▲	▲	▲	■	▲	▲
Iodine	●	●	●	●	▲	▲	■	●	▲	■			●	●	■	●	●	●	▲	▲
Isobutyl alcohol	▲	▲	▲	▲	▲	▲	■	■	▲	▲			■	●	▲	▲	▲	■	▲	▲
Isopropyl alcohol	▲	▲	▲	▲	▲	▲	■	■	▲	▲			■	●	▲	▲	▲	■	▲	▲
Isopropyl benzene	■	●	▲	■	■	●	●	●	●	●			●	●	●	●	●	●	▲	▲
Lactic acid	▲	▲	▲	▲	▲	▲	▲	▲	▲	▲	▲	▲	■	●	▲	▲	■	■	▲	▲
Mercurous chloride	▲	▲	▲	▲	▲	▲	▲	■	▲	▲			▲	▲	▲	▲	●	●	▲	▲
Mercury	▲	▲	▲	▲	▲	▲	▲	▲	▲	▲			▲	▲	▲	▲	▲	▲	▲	▲
Methyl acetate	■	●	■	■	▲	■	●	●	▲	▲	●	●			●	●	●	●	▲	▲
Methyl alcohol	▲	■	▲	▲	▲	▲	■	●	▲	▲	■	●	●	●	▲	■	▲	■	▲	▲
Methyl propyl ketone	▲	■	▲	▲	▲	■	●	●	■	■			●	●	●	●	●	●	▲	▲
Methylene chloride	●	●	■	●	●	●	●	●	●	●	●	●	●	●	●	●	●	●	▲	▲
Mineral oil	▲	■	▲	▲	▲	▲	▲	▲	▲	▲			▲	▲	▲	▲	▲	▲	▲	▲
Monochloroacetic acid	▲	▲	▲	▲	▲	▲	●	●	▲	▲			■	●	■	●	▲	▲	▲	▲
Nitric acid (10 %)	▲	▲	▲	▲	▲	▲	●	●	▲	▲	▲	▲	▲	■	▲	■	▲	■	▲	▲
Nitric acid (50 %)	■	■	■	●	■	●	●	●	■	●			■	■	▲	■	■	●	▲	▲
Nitric acid (70 %)	●	●	●	●	●	●	●	●	■	●	●	●	■	●	●	●	●	●	▲	▲
Nitrobenzene	●	●	■	●	●	●	●	●	●	●	●	●	●	●	●	●	●	●	▲	▲
Oxalic acid	▲	▲	▲	▲	▲	▲	▲	▲	▲	▲	▲	■	▲	▲	▲	▲	▲	▲	▲	▲
Ozone	▲	▲	▲	▲	▲	▲	■	■	▲	▲			▲	▲	▲	▲	▲	■	▲	▲
Perchloric acid	▲	●	▲	●	▲	●	●	●	■	●	●	●	●	●	●	●	■	●	▲	▲
Perchloroethylene	●	●	●	●	●	●	●	●	●	●			■	●	●	●	●	●	▲	▲
Phenol (100 %)	▲	■	▲	▲	▲	▲	●	●	■	■			●	●	●	●	●	●	▲	▲
Phosphoric acid (85 %)	▲	▲	▲	▲	▲	▲	▲	■	▲	▲	▲	▲	●	●	▲	▲	▲	■	▲	▲
Phtalat dibutyllic	■	●	■	●	▲	■	●	●	▲	■			●	●	●	●	●	●	▲	▲
Potassium chloride	▲	▲	▲	▲	▲	▲	■	■	▲	▲			▲	▲	▲	▲	▲	■	▲	▲
Potassium hydroxide	▲	▲	▲	▲	▲	▲	■	■	▲	▲	▲	▲	▲	▲	●	●	■	■	▲	▲
Potassium permanganate	▲	▲	▲	▲	▲	▲	▲	▲	▲	▲	■	■	▲	▲	▲	▲	▲	▲	▲	▲
Propylene glycol	▲	▲	▲	▲	▲	▲	▲	▲	▲	▲	▲	▲			▲	■	●	●	▲	▲
Propylene oxide	▲	▲	▲	▲	▲	▲	●	●	▲	▲					●	●	●	●	▲	▲
Pyridine	▲	■	▲	■	■	■	●	●	▲	■	●	●	●	●	●	●	■	●	▲	▲
Salicylic acid	▲	▲	▲	▲	▲	▲	▲	▲	▲	▲							■	●	▲	▲
Salicylic aldehyde	▲	▲	▲	▲	▲	▲	●	●	▲	▲					■	■	●	●	▲	▲
Silver acetate	▲	▲	▲	▲	▲	▲	■	■	▲	▲			■	■	▲	▲	■	■	▲	▲
Silver nitrate	▲	▲	▲	▲	▲	▲	■	■	▲	▲			▲	▲	▲	▲	■	■	▲	▲
Sodium acetate	▲	▲	▲	▲	▲	▲	▲	▲	▲	▲			●	●	▲	▲	■	■	▲	▲
Sodium dichromate	▲	▲	▲	▲	▲	▲	▲	▲	▲	▲			▲	▲			▲	▲	▲	▲
Sodium hydroxide	▲	▲	▲	▲	▲	▲	▲	▲	▲	▲	▲	▲			●	●	▲	▲	▲	▲
Sulfuric acid (60 %)	▲	▲	▲	▲	▲	▲	●	●	▲	▲			●	●	■	■	■	●	▲	▲
Sulfuric acid (98 %)	■	●	■	●	●	●	●	●	▲	▲	●	●	●	●	●	●	●	●	▲	▲
Tartaric acid	▲	▲	▲	▲	▲	▲	▲	▲	▲	▲			■	■	▲	▲	▲	▲	▲	▲
Tetrahydrofuran	●	●	■	●	●	●	●	●	■	●	●	●	●	●	●	●	●	●	▲	▲
Toluene	■	●	■	■	■	●	●	●	■	●	●	●	●	●	●	●	●	●	▲	▲
Trichloroethane	●	●	■	●	●	●	●	●	●	●			●	●	●	●	●	●	▲	▲
Trichloroethylene	●	●	■	●	●	●	●	●	●	●	●	●	●	●	●	●	●	●	▲	▲
Triethylene glycol	▲	▲	▲	▲	▲	▲	▲	■	▲	▲			■	■	▲	■	■	●	▲	▲
Tripropylene glycol	▲	▲	▲	▲	▲	▲	▲	▲	▲	▲			■	■	▲	■	■	●	▲	▲
Turpentine	■	●	■	●	●	●	●	●	■	■	●	●	▲	▲	●	●	▲	▲	▲	▲
Urea	▲	▲	▲	▲	▲	▲	▲	▲	▲	▲			▲	▲	●	●	■	●	▲	▲
Vinylidene chloride	●	●	■	●	●	●	●	●	●	●			●	●	●	●	●	●	▲	▲
Xylol	■	●	■	●	●	●	●	●	■	●	●	●	●	●	●	●	●	●	▲	▲
Zinc chloride (10 %)	▲	▲	▲	▲	▲	▲	▲	▲	▲	▲			●	●	▲	▲	▲	■	▲	▲
Zinc sulphate (10 %)	▲	▲	▲	▲	▲	▲	▲	▲	▲	▲	●	●	■	■	▲	▲	▲	■	▲	▲

▲ = Excellent / very good chemical resistance

■ = Good / limited chemical resistance

● = Poor chemical resistance

## CHEMICAL RESISTANCES

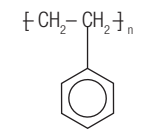
	POLYSTYRENE	POLYETHYLENE HIGH DENSITY	POLYETHYLENE LOW DENSITY	POLYPROPYLENE
GENERAL PROPERTIES	PS Crystal (GPPS)	PEHD	PELD	PP Homopolymer
Structure	Amorphous structure 	Structure with few ramifications, greater compaction $\text{[-CH}_2\text{-CH}_2\text{-]}_n$	Very branched chain structure, greater flexibility $\text{[-CH}_2\text{-CH}_2\text{-]}_n$	Partially crystalline $\text{[-CH}_2\text{-CH(CH}_3\text{)-]}_n$
Optical properties	TRANSPARENT	TRANSLUCENT	TRANSLUCENT	TRANSLUCENT
Mechanical resistance	Rigid and hard but fragile Low impact resistance	Rigid Very good impact resistance	Less stiffness and toughness than PEHD Good impact resistance	Rigid
Density	1.04 - 1.05 g/cm <sup>3</sup>	0.924 - 0.980 g/cm <sup>3</sup>	0.918 - 0.927 g/cm <sup>3</sup>	0.898 - 0.950 g/cm <sup>3</sup>
Max. temperature	70° C	80° C	75° C	121° C
Min. temperature	-10° C	-50° C	-50° C	0° C*
Autoclavable	NO	NO	NO	YES
Gas sterilization	DOSES LIMITED	YES	YES	YES
Gamma irradiation Sterilization	YES	YES	YES	DOSES LIMITED
Beta irradiation Sterilization	YES	YES	YES	DOSES LIMITED
Water absorption	0.098 - 0.11 %	0.010 - 0.011 %	0.010 - 0.011 %	0.010 - 0.10 %
Properties	- Insulator, low electrical conductivity - Sparkly	- Excellent thermal and chemical resistance - Easily charges static electricity	- Good thermal and chemical resistance - Easily charges static electricity	- Resists better high temperatures - Great resistance to stress cracking - Lightweight

\*There are special blends of PP like those from our cryovials, which are able to withstand up to -196 °C.

	POLYSTYRENE	HIGH DENSITY POLYETHYLENE	LOW DENSITY POLYETHYLENE	POLYPROPYLENE
GENERAL CHEMICAL RESISTANCE	PS	PEHD	PELD	PP STANDAR
Oils	LIMITED	LIMITED	LOW	GOOD
Acids	LIMITED*	GOOD	GOOD*	GOOD*
Alcohol	GOOD	GOOD*	GOOD	GOOD
Bases	GOOD	GOOD	GOOD	GOOD
Ketones	NULL	LIMITED	LIMITED	LIMITED
Esters	LOW	LIMITED	LIMITED	LIMITED
Fats	GOOD	GOOD	GOOD	GOOD
Hydrocarbons -aromatics	NULL	LIMITED	LOW	LOW
Hydrocarbons Chloride	See**	LIMITED	LIMITED	See**
Hydrocarbons Halogenated	NULL	LOW	NULL	LOW
Metals (Cu, Mn, Co)	See**	See**	See**	LIMITED
Oxidants	NULL	LOW	LOW	LOW

\* LOW for certain acids and depending on the concentration.

\*\* The chemical resistance of plastics is detailed in the specific table of resistance according to the different chemical compounds.



## STERILISATION METHODS

### TYPES OF STERILIZATION

METHOD	Dry heat	Autoclave, Super Heated Steam under pressure	Ethylene Oxide ("EO Gas")
PROCEDURE	Direct action of dry heat. For example: 171 for 60', 160 for 120' or 140 for 180'.	Action of 3 elements: temperature, water steam and pressure 121 °C (20') (+1 atm)	Exposure of the material to the gas for a time that can reach up to 8h, at a temperature between 40°C and 50°C and with a relative humidity between 50% and 60%.
RECOMMENDED FOR	Glassware, metals and liquids.	Glassware, fabrics, liquids etc. All materials resistant to heat above 121°C and moisture.	All materials with some exceptions. It is often used when materials to be sterilized are sensitive to steam or radiation.
PRECAUTIONS	High temperatures may damage fragile metals.	It is not recommended for some types of plastic. In the case of closed containers, the caps must not be adjusted (steam must be allowed to enter and exit easily).	Requires a subsequent ventilation to ensure sterilised products are free of residual gases that may be toxic.
LIMITATIONS	The own material's limitations. High heat soaking may unacceptably affect material properties.	Generally for low volume products.	Ethylene oxide is toxic and explosive.

**STERILE A STERILIZATION TYPE:** in this case the parts are not sterilized at the end of its manufacture process since is the process by itself which is able to obtain a sterile product. This is because the entire process from injection of different plastic components to the assembly is protected by a sterile atmosphere, thanks to the cowl of the entire installation and the placement of laminar flows that create an overpressure sterile air inside the facilities.

### CENTRIFUGATION

#### Conversion G y R.P.M.

The **relative centrifugal force (RCF)** can be determined using the formula:

$$FCR = 1.118 \times 10^{-6} \times r \times n^2$$

r= radius of the rotor (mm); distance between the axis of the rotor and the farthest wall of the tube.

n= rotating speed (revolutions per minute).

The result is expressed in terms of acceleration (g); 1 g is equal to 9.807 m/s<sup>2</sup>.

It is recommended that the centrifuge caps fit in size and shape to the tubes to be centrifuged.

#### CONVERSION (°F - °C - °K)

°F (Fahrenheit) = (°C x 1.8) + 32	°C (Celsius) = (°F - 32) x 0.556	°K (Kelvin) = °C + 273.15
-----------------------------------	----------------------------------	---------------------------

## TYPES OF STERILIZATION

METHOD	By ionizing radiation (gamma rays)	By ionizing radiation (beta rays)
PROCEDURE	Photons emitted by the radioisotope Co-60.	High energy electrons generated in a particle accelerator.
RECOMMENDED FOR	Widely used in industries to sterilise single use material. Sterilisation doses are calculated from bioburden counts.	Widely used in industries to sterilise single use material. Sterilisation doses are calculated from bioburden counts.
PRECAUTIONS	Limitations in some applications, as some material properties may be unacceptably altered by this method.	Limitations in some applications, as some material properties may be unacceptably altered by this method.
LIMITATIONS	The effects are cumulative, so the material that has been sterilized by this method cannot be re-sterilized by many other conventional methods (eg ethylene oxide), after its initial use.	The electron beam has limited penetration power, so the density of the product to be sterilized must be taken into account. The effects are cumulative, so the material that has been sterilized by this method cannot be re-sterilized by many other conventional methods (eg ethylene oxide), after its initial use.

The sterilization indicator labels are small round stickers that change their colour when the material is properly sterilized:

Radiation: from yellow to red.

Ethylene oxide: from violet to green.

## CONVERSION CHART XG - R.P.M.

r \ xg	1,000 xg	1,500 xg	2,000 xg	2,500 xg	3,000 xg	3,500 xg	4,000 xg	4,500 xg	5,000 xg	10,000 xg	15,000 xg
50 mm	rpm 4,227	5,177	5,978	6,683	7,321	7,908	8,454	8,967	9,452	13,367	16,371
75 mm	3,451	rpm 4,227	4,881	5,457	5,978	6,457	6,903	7,321	7,717	10,914	13,367
100 mm	2,989	3,661	rpm 4,227	4,726	5,177	5,592	5,978	6,340	6,683	9,452	11,576
125 mm	2,673	3,274	3,781	rpm 4,227	4,630	5,001	5,347	5,671	5,978	8,454	10,354
150 mm	2,440	2,989	3,451	3,859	rpm 4,227	4,566	4,881	5,177	5,457	7,717	9,452
175 mm	2,259	2,767	3,195	3,572	3,913	rpm 4,227	4,519	4,793	5,052	7,145	8,751
200 mm	2,113	2,588	2,989	3,342	3,661	3,954	rpm 4,227	4,483	4,725	6,683	8,185
225 mm	1,993	2,440	2,818	3,151	3,451	3,728	3,985	rpm 4,227	4,456	6,301	7,717
250 mm	1,890	2,315	2,673	2,989	3,274	3,537	3,781	4,010	rpm 4,227	5,978	7,321

Description	page
<b>A</b>	
ABS trays	264
Absorbent paper	250
Acetal polymer racks	226
Adhesion microscope slides	109
Adhesive labels	246
Adhesive sealing film	76
Aluminum racks	231
Aluminum sealing foil	76
Analytical funnels	258
Anticoagulants and preservatives in containers	92
Assembling rack	225
Autoclave resistant red bags	245
Automatic slide dispenser	118
AYRE plastic spatula	147
AYRE wood spatula	147
<b>B</b>	
Bags for Autoclave	245
Baskets for autoclave	237
Beakers with three spouts	257
Bed pan	251
Biopsy and tissue cassettes	104
Biopsy bags	101
Biopsy cassettes	104
Biopsy cassettes. Histosette I	102
Blood collection tubes with pierceable and re-sealable rubber caps	91
Blood group test plate	89
Blood-plasma. Edta tubes: dipotassium	87
Blue containers 60 and 150 ml	130
Bottle carrier with folding handlers	236
Bottle with thiosulfate for water analysis 120 ml	51
Bottles for sterilization	275
Bottles for water sampling	146
Bottles with standard, narrow neck	284
Bottles with standard, wide neck	284
Büchner funnels	259
Buckets with spout	282
Burette clamps	260
<b>C</b>	
Canes for cryovials	175
Capillary tubes sealing wax	92
Caps for screw thread microtubes	64, 65, 172, 173
Caps for the above tubes	175
Caps polyethylene	155
Cardboard waste containers	243
Cassette for biopsy 6 compartments	101
Cassettes for biopsy. Histosette II	103
Cassettes for tissue	102
Cassettes for tissue. Histosette I	102
Cassettes for tissue. Histosette II	103
Cassettes without lid	101
Cell and Tissue Culture Dishes	61

Description	page
Cell and Tissue Culture Flasks	60
Cell and Tissue Culture Multiwell Plates	60
Cell Scrapers (normal and rotatable)	61
Cell spreader. Sterile	37
Cell strainer	61
Cellulose acetate syringe filters - DeltaGo	48
Centrifugal tubes 15 ml and 50 ml	41, 158
Circular support to house 6 single-channel pipettes	200
Cobas Mira cuvette segments	94
Colour coded inserts	174
Coloured adhesive tapes for sample identification	246
COMBI Rack for PCR tubes	221
Combi rack height 128	226
Conical measuring flasks	257
Conical tube 50 ml	42, 43, 62, 158, 159
Conical tubes	154
Conical tubes 15 ml	42, 62, 159
Connectors «Straight» and 3 way	268
Connectors with «T» shape	266
Connectors with «Y» shape	266
Contact plates	35
Containers	125
Containers 120 ml	129
Containers 40 ml	124
Containers and tubes for vacuum system	134
Containers uncapped 120 ml	128
Containers with boric acid 30 ml	124
Containers with spoon 120 ml	128
Coplin type staining jar	114
Coulter counter cups	95
Cover slides	107
CRYOINSTANT: Cryoplates for conservation of microbiological strains	25
Cryovials printed without graduation	175
Cryovials with external threads	66, 174
Cryovials with graduation and band	175
Cryovials with internal threads	66, 174
Cups 25 ml	141
Cuvette rack 42 well	222
Cylinder with handle	290
Cylindrical container graduated up to 2 litres with handle	137
Cylindrical or octahedral stirring bar assortment pack	269
Cylindrical slide mailer	117
Cylindrical stirring bars	271
Cytology brush	147
<b>D</b>	
Deep well plate (96 round wells)	77
Deep well plate (96 square well, round bottom)	77
Deep well plate (96 wells or 12 rectangular channels)	77
Dental containers	251
Digital timers	269
Disconnectors / connectors	268
Disposable cups	131, 280

Description	page
Dividers to W-Coat and W-Coat AIY	179
Double-sided pipetting reservoir	200
Drum with screen and childproof cap	290
Drums with tap	292
Drying rack	262
<b>E</b>	
E.S.R. semi micro system TAKIVES with self-levelling system	88
E.S.R. with self-levelling system	88
Economical storage box	106
Edta: tripotassium	87
Edta: tripotassium. Rubber cap	87
Emergency eyewash bottle	247
Enrichment LIM Broth medium	24
Enrichment Selenite medium	24
Enrichment Thioglycolate medium	24
Erlenmeyer flasks	255
Extra long pipettes	203
<b>F</b>	
Fast read plate for urinary sediment cell count	94, 131
Filter paper	250
Flask weight ring	261
Flat bottom screw threaded vials	164
Flexible PCR plate 96 well	73
Flocked swabs with Amies transport medium	22
Flocked swabs with Cary Blair transport medium	22
Flocked swabs with ViCUM® transport medium	23
Flocked swabs with Virus® transport medium	23
Flocked swabs without transport medium	21
Flow indicator	268
Forceps	106
Freezing cardboard storage box, pre-assembled compartments	214
Funnels	258, 294
<b>G</b>	
General features of our caps	156
General purpose pipettes	202
Glass Pasteur pipettes with open an closed tip	204
Glass Pasteur pipettes with open an closed tip	273
Graduated 0.5 ml PCR tubes	70
Graduated beakers	256
Graduated beakers low form	275
Graduated blue beakers	256
Graduated container 200 ml	130
Graduated containers 60 ml	126
Graduated cylinder	273
Graduated measuring cylinders pentagonal base	254
Graduated microtube 2 ml	169
Graduated microtube 5 ml	169
Graduated microtubes. DNase, RNase free 1.5 ml	168
Graduated narrow neck bottles	286
Graduated narrow neck opaque bottles	286
Graduated pipette	274
Graduated pipettes	201

Description	page
Gridded cellulose nitrate filters - DeltaGo	47
<b>H</b>	
Handrop® digital - MC pipettes	198
Handrop® digital - SC pipettes	198
Handrop® stand for pipettes	200
Hexagonal weighing dishes	265
High speed funnels	258
Hinged lid container 50 ml	140
Histology mould	100
Hydrophobic PTFE & Hydrophilic PTFE/L syringe filters - DeltaGo	49
<b>I</b>	
Incubation rack 24 well	218
Industrial drums	295
Industrial jugs	282
Instrument trays	236
Integral wash bottles	249
Interlocking tube racks 20 well	219
Iodoacetate lithium + heparin lithium tubes	86
Isofreeze Rack with temperature indicator	217
IsoFreeze reversible racks with lid	218
Isothermal bags	146
<b>J</b>	
Jar for anaerobiosis incubation	34
Jars with lid	98, 281
<b>K</b>	
Kit for the detection of sexually transmitted infections	27
<b>L</b>	
Laboratory holders	266
Laboratory spatulas	263
Laboratory storage cabinet	105
Large deep trays	294
Latex gloves	253
Leak proof screw cap containers	99
Lids for cassettes	101
Lithium heparin tubes	86
Long-handled dippers	54
Low profile PCR plate 96 well	74
Low profile skirted PCR plate 96 well	73
Low profile, semi-skirted plate 96 wells	75
Low profile, semi-skirted white plate	75
<b>M</b>	
Macrotip 2 - 10 ml	195, 196
Mailing container	89
Manual code reader W-READER 2D and 1D	178
Measuring cylinders with pentagonal base	254
Measuring scoops	263
Meat sampling kit	57
Mega cassettes	103
Metal tray histology	100
Metalic cryoracks for sample storage	179
Micro stirring bars	270

Description	page
Microhaematocrit capillary tubes	92
Micropipettes	203
Microscope slide boxes	118
Microscope slide labels 23 x 23 mm	110
Microtitre plates, sterile	36
Microtube racks 50 well	219
Microtube racks with lift-off telescopic lid	215
Microtubes 0.5 ml	166
Microtubes 1.5 ml	166
Microtubes rack 5ml	220
Microtubes with attached caps 2 ml	168
Microtubes with secure lock pick-up tab 1.5 ml	167
Microtubes, Beckman® type 0.4 ml	165
Microtubes, Vitatron® type 0.5 ml	165
Modular storage drawers	106
Moulded 90 or 100 mm Petri dish rack	35
Moulded contact plate rack	35
Mounting medium for microscopy	110
<b>N</b>	
Narrow neck, high resistance bottles	286
Nasal self-sampling kit with virus medium	27
Needle collection container	241
Nichrome wire loops	37
Nitrile gloves	253
Non Coded Tubes	176
Non graduated serological pipettes. Sterile	204
Non-return valve	268
Nozzle bottles	288
Nylon syringe filters - DeltaGo	49
<b>O</b>	
Octahedral stirring bars with pivot ring	271
One-hand timer	269
Opaque skirted 96 well PCR plate	73
Ovoid stirring bars	271
Owder funnels	259
<b>P</b>	
Paraffin	100
PCR racks with lid	217
PCR sealing mat	76
PCR tubes 0.2 ml	67
PCR tubes in strips 0.2 ml	68
PCR workstations	220
PES membrane filters - DeltaGo	48
PET 8 strip caps polyethylene	178
Petri Dish 120 x 120 mm squared	33
Petri Dish 140 x 20 mm	33
Petri Dish 55 x 14 mm	33
Petri Dish 90 x 14 mm	32
Petri Dish 90 x 14 mm, three compartments	32
Petri Dish 90 x 14 mm, two compartments	32
Petri Dish 90 x 15 mm with internal cross	33
Petri Dish 90 x 15 mm, four compartments	32

Description	page
Petri Dish 90 x 25 mm	33
Petri dish baskets	34
Pipette pumps	44, 207, 248
Pipette rack	222
Pipette rinsing set	261
Pipette stand	260
Pipette trays	207
Pipettes with 1 or 2 marks	274
Pipetting bulb	44, 206, 248
Pipetting bulbs	206
Pipetting reservoir	200
Plastic tongue depressors	250
Plastic tray for blood collection tubes	234
Plate skirted 384 well	70
Plug Style caps W-SEAL	178
Polycarbonate membranes - DeltaGo	47
Polycarbonate racks for cryovials	210
Polyethylene beakers	280
Polyethylene wide mouth jars with lid and insert plug	98, 278
Polypropylene containers 60 ml	127
Polystyrene containers	126
Polystyrene racks for cryovials	210
Polystyrene round bottom tubes capped	153
Polystyrene round bottom tubes, capped and labelled	153
Premium 1.5 microtube. Safety lock	167
Pressure cap for glass tubes	161
PVC Antiacid trays	264
PVC Pipette tray	264
<b>R</b>	
Rack 10x10 height 37	214
Rack 1x1 height 45	227
Rack 1x1 height 70	227
Rack 4x4 height 45	214
Rack 5x5 round hole height 105	229
Rack 5x5 round hole height 128	229
Rack 7x7 height 50	213
Rack 7x7 height 80	228
Rack 7x7 height 96	228
Rack 8x8 round hole height 45	213
Rack 8x8 round hole height 50	213
Rack 9x9 height 45	212
Rack 9x9 height 50	212
Rack 9x9 height 70	227
Rack 9x9 height 80	228
Rack 9x9 height 95	212
Rack 9x9 height 96	229
Rack for refill	195
Rack for sedimentation cones	259
Racks 80 well	216
Racks for 96 PCR tubes with lid	220
Racks for bags	236
Racks for containers up to 23 mm Ø	164, 233

Description	page
Racks for containers up to 28 mm Ø	233
Racks for containers up to 30 mm Ø	234
Racks for containers up to 38 mm Ø	235
Racks for containers up to 47 mm Ø	235
Racks for containers up to 58 mm Ø	235
Racks with lid	215
Real Time PCR tubes 0.2 ml	67
Real Time PCR tubes in strips 0.2 ml	69
Re-caps	155
Rectangular base for burettes	260
Rectangular bottles	288
Rectangular containers, graduated up to 2 litres	138
Rectangular graduated until 3 litres container with handle	135
Rectangular waste container (PP)	243
Reversible 96 well racks with lid	221
Reversible racks with removable handles	216
Rhomboid weighing dishes	265
Robotic and conductive tips for TECAN	197
Robotic Tips for Hamilton (300µl and 1,000µl)	197
Robotic Tips for Qiagen (300µl and 1,100µl)	197
Rotary pipette stand	260
Round baskets with handle	237
Round bottom glass tubes	162
Round bottom polystyrene tubes	150
Round incubation racks	218
Round jugs with handle	282
<b>S</b>	
Safety containers	242
Safety containers for solid waste type II and III	240
Safety glasses	247
Safety gloves	252
Safety labelling	241
Safety lock microtubes	167
Sample cups	94, 95
Sample storage system	78, 79, 180, 181
Scintillation vials	95
Screw cap container 200 ml	130
Screw cap containers 160 ml	129
Screw cap containers with seal and dropper	287
Screw cap microtubes, with cap. Sterile	64, 172
Screw cap tubes 12 ml, round bottom	40
Screw caps for the above tubes	163
Screw thread microtubes	64, 65, 172, 173
Screw thread tamper evident microtubes	65, 173
Screw threaded glass tubes	163
Security screw cap containers	99, 136, 141
Sedimentation cone «IMHOFF»	259
Self sealing security jars	283
Semi-skirt plate 96 well	74
Serum glucose serotub	83
Serum tubes with clot accelerator and gel serum separator	84
Serum tubes with clot accelerator and granule serum separator	85

Description	page
Set of mixed Combi rack	224
Silicone and TPE tourniquet	83
Silicone sheets	267
Silicone tubing. Non toxic	267
Single channel and variable volume NICHIPET PREMIUM pipettes	199
Single use racks	226
Single variable volume NICHIPET EXII	199
Slide mailer	116
Slide printer microscope slides	109
Slide storage boxes	117, 118
Slide storage system for 100 slides. Stackable	119
Slide storage system for 50 slides. Stackable	119
Slide tube mailer	116
Slidefolders	115
Slides	107
Special paediatrics	91
Special purpose pipettes	203
Specimen transport kangaroo bags	144
Spectrophotometer cuvettes	93
Speed sedimentation citrate for paediatrics	88
Square baskets with optional lid	237
Square containers with star-shaped caps	283
Squared bottles	289
Squared containers, graduated up to 2.7 l	139
Squared weighing dishes	265
Stackable drum with tamper evident screw cap	293
Stackable drums with tamper evident caps	291
Stackable Petri dish incubation tray	36
Stacking PCR work up rack	221
Staining jar	114
Staining jar and dish	112
Staining jars with lid	112
Staining racks	114
Staining tray	110
Stainings racks for microscope slides	237
Stainless steel racks	231
Standard 1.5 ml microtubes	166
Standard plate 96 well	74
STAR FROST® ADHESIVE slides	108
STAR FROST® slides	108
Sterile bags for STOMACHER® blenders	56
Sterile bottles for water sampling	53
Sterile calibrated loops	38, 39
Sterile culture tubes in polystyrene	40, 63, 157
Sterile homogeniser full size filter bag	55
Sterile homogeniser lateral filter bag	55
Sterile jars for water sampling	52
Sterile serological pipettes	45, 63, 205
Sterile single use Straw-like pipettes	204
Sterile Whirl-Pak® blender bags with and without filter	56
Sterile Whirl-Pak® sampling bags	143
Sterilization indicator tapes	244

Description	page
Stirring bar retriever	270
Streaking needles	38
Styrofoam racks without lid	219
Surface kit	31
Swab for surface control: Aerobic	29
Swab for surface control: E.Coli and Coliforms	31
Swab for surface control: Listeria spp	29
Swab for surface control: Molds and yeasts	30
Swab for surface control: Salmonella spp	30
Syringes	89, 145
<b>T</b>	
Tamper evident bottles, tall models	287
Tamper evident buckets, large capacity	281
Tamper evident, buckets with lid	98
Tamper evident, polyethylene bottles	287
Test tube baskets	222
Tip 0.1 - 10 µl	185
Tip 0.1 - 200 µl	188
Tip 0.5 - 20 µl	185
Tip 1 - 200 µl	188
Tip 100 - 1,000 µl	192, 193
Tip 2 - 100 µl	186
Tip 2 - 20 µl	186
Tip 2 - 200 µl	187, 190, 195
Tip 2 - 30 µl	186
Tip 2 - 300 µl	190
Tip 20 - 300 µl	191
Tip 200 - 1,000 µl	193
Tip 5 - 1,000 µl	193
Tip 5 - 200 µl	189, 190, 191, 195
Tip 5 to 100/200 µl	187
Tip 50 - 1,000 µl	191, 195
Tip 50 - 1,250 µl	192
Tissue embedding sponge	100
Tissue grinders-homogenisers	55
Traditional swabs in tube without transport medium Human DNAsa, RNAsa and DNA free	16, 66
Traditional swabs in tube without transport medium sterile	16
Traditional swabs without transport medium non sterile	14
Traditional swabs without transport medium sterile	15
Transport swab with Amies medium	18
Transport swab with Cary Blair medium	19
Transport swab with Chlamydia medium	20
Transport swab with Liquid Amies medium	18
Transport swab with Stuart medium	19
Tubes for small blood volumes	91
Tubes round bottom 12 ml screw cap	157
Tubes with W-2D Datamatrix coding	177
Tubing clamps	266
<b>U</b>	
Ultra clear polypropylene round bottom tubes	152
Universal polypropylene containers 30 ml	123

Description	page
Universal polystyrene containers 30 ml	122
Universal racks	223
Universal test tube racks	225
Urine collection bottle	251
Urine container set	131
<b>V</b>	
Vacuum container with an innovative sterility seal 60 ml	133
Vacuum filtration	62
Vacuum pump	261
Vaginal self-sampling kit	27
Vaginal speculum	147
Volumetric flask	273
Volumetric flasks with stopper	255
<b>W</b>	
W-2DRP I Tubes with coding and Right Position System	177
Wash bottles	249
Watch glasses	265
W-Coat	179
Whirl-Pak® bags with flat wires	142
Whirl-Pak® bags with sodium thiosulfate	54
Whirl-Pak® stand-up bags	142
Whirl-Pak® surface sampling bags	57
White strip zip-lock bags	144
Wide and narrow neck drums	292
Wide mouth drums with security cap	291
Wide mouth storage drums with tap and plug	294
Wide neck graduated containers with star-shaped cap	285
Wood tongue depressors	250
W-RACK 96 Cryoboxes (empty)	178
<b>Z</b>	
Zip-lock bags	144

code	page	code	page	code	page	code	page	code	page
14	287	15003	56	19375	292	19604	294	120003	250
24	287	15004	56	19384	247	19605	294	120010	250
27	88	15005	55	19385	247	19660	292	122000	55
29	88	15006	56, 236	19386	247	19662	292	132832	88
34	287	19139	260	19400	269	19664	292	140064	92
44	287	19140	260	19408	285	19666	292	141746	94, 131
90	241	19146	258	19409	285	19698	271	150611	147
330	224	19147	258	19410	285	19700	236	150613	147
701	204, 273	19148	258	19411	285	19705	271	150614	147
702	204, 273	19150	258	19412	285	19748	271	160264	92
703	273	19152	258	19418	268	19750	271	161364	92
704	273	19153	258	19423	257	19751	271	161464	92
705	273	19166	259	19424	257	19753	271	161964	92
706	273	19167	259	19425	257	19756	271	191047	244
707	273	19168	259	19435	268	19757	271	191048	244
708	273	19169	259	19441	259	19758	271	191049	244
709	273	19172	258	19442	259	19763	271	191055	259
712	204, 273	19173	258	19443	259	19764	271	191056	259
715	274	19174	258	19445	259	19786	271	191057	263
716	274	19175	258	19454	265	19787	271	191058	263
717	274	19195	206	19455	265	19788	271	191059	263
718	274	19200	44, 206, 248	19460	266	19793	271	191060	263
719	274	19201	44, 206, 248	19461	266	19797	271	191062	263
720	274	19212	262	19462	266	19806	271	191063	263
721	274	19213	262	19465	266	19810	271	191064	263
722	274	19217	261	19467	266	19811	271	191065	263
723	274	19218	261	19468	266	19852	270	191066	263
724	274	19219	261	19500	106	19855	270	191067	263
725	274	19221	261	19501	106	19856	270	191068	263
726	274	19252	207, 264	19503	106	19901	269	191069	263
727	274	19254	260	19504	266	19905	282	191070	263
728	274	19262	260	19505	266	19906	282	191071	263
729	274	19265	260	19510	268	19907	282	191087	114
730	275	19266	260	19512	268	19919	270	191104	113
731	275	19267	260	19513	268	19922	117	191105	113
732	275	19270	252	19535	268	19923	116	191106	113
733	275	19277	118	19538	268	19924	116	191107	113
734	275	19278	118	19539	268	19926	116	191108	113
735	275	19280	264	19540	118	19971	266	191220	246
736	275	19281	264	19563	225	19972	266	191222	244
737	275	19282	264	19564	225	19973	222	191223	244
738	275	19283	264	19565	225	19996	207, 264	191395	261
739	275	19284	264	19566	225	44125	103	191461	255
750	273	19285	264	19567	225	44140	103	191462	255
751	273	19319	286	19568	225	44141	103	191463	255
752	273	19323	286	19570	225	44143	103	191464	255
753	273	19324	286	19575	54	44145	103	191465	255
754	273	19325	286	19576	54	44147	103	191484	255
755	273	19326	286	19577	54	44240	101	191485	255
756	273	19351	112	19586	251	44245	101	191486	255
845	78, 180	19353	112	19591	251	53020	287	191487	255
1164	88	19354	112	19593	263	53125	287	191488	255
1361	88	19355	112	19596	263	53250	287	191489	255
15001	56	19360	114	19603	294	120002	250	191578	290



code	page	code	page	code	page	code	page	code	page
191579	290	192951	101	200070	191	200358	143	206020	291
191597	284	192952	101	200071	192	200359	143	206025	291
191603	284	193241	286	200072	187	200361	142	208030	295
191610	284	193251	286	200074	190	200363	143	208031	295
191612	284	193914	206	200075	194	200364	143	208060	295
191614	284	194171	258, 294	200076	190	200365	142	208061	295
191616	284	194172	258, 294	200077	191	200373	56	208128	295
191618	284	194175	258, 294	200078	187	200374	56	209030	294
191623	284	194176	258, 294	200079	188	200376	56	209050	294
191625	284	194177	258, 294	200082	192	200381	57	210002	202
191627	284	194178	258, 294	200083	196	200382	57	210003	202
191629	284	195703	264	200100	245	200390	27	210004	202
191631	284	195705	264	200103	95	200391	27	210005	203
191633	249	195706	264	200121	202	200392	27	210006	203
191634	249	195707	264	200180	29	200398	31	210022	202
191637	249	195709	264	200181	29	200399	31	210023	202
191638	249	195711	264	200182	30	200400	166	210024	202
191640	292	195713	264	200183	30	200401	166	210030	203
191642	292	196102	55	200184	31	200405	166	222802	98, 281
191646	292	196105	55	200200	32	200407	166	222803	98, 281
191721	256	196110	55	200201	33	200410	166	222804	98, 281
191722	256	196115	55	200202	32	200420	219	222805	98, 281
191723	256	196302	55	200203	32	201110	203	232820	242
191724	256	196305	55	200208	35	202248	131, 280	232821	242
191725	256	196310	55	200209	32	202317	131, 280	232822	242
191726	256	196315	55	200210	32	202506	290	232826	242
191727	256	199075	194	200214	33	202605	293	232828	242
191822	256	199083	189	200215	33	202610	293	232829	242
191823	256	200000	202	200218	35	202625	293	232831	242
191824	256	200001	202	200219	33	202630	293	240007	240
191825	256	200002	201	200310	245	202705	291	240011	241
191826	256	200003	201	200311	245	202710	291	240021	241
191827	256	200004	201	200312	245	202801	278	240028	241
191828	256	200005	202	200318	245	202802	98, 278	240065	243
191829	256	200006	201	200320	245	202803	98, 278	241010	98, 281
192470	261	200007	201	200321	245	202809	98, 278	241011	98, 281
192471	261	200009	189	200322	245	202810	98, 278	241013	98, 281
192472	261	200012	191	200325	143	202813	98, 279	241014	98, 281
192562	254	200014	195	200326	143	202814	98, 278	241015	98, 281
192563	254	200015	196	200329	143	202815	279	242000	240
192564	254	200016	187	200330	143	202818	98, 279	242803	280
192565	254	200017	190	200332	143	202820	279	242806	280
192566	254	200018	193	200333	143	202823	279	242811	280
192567	254	200019	191	200340	143	202828	279	243500	240
192572	254	200020	193	200341	143	202839	279	244109	219
192573	254	200021	193	200342	56, 143	202840	136	244111	219
192574	254	200024	185	200343	56, 143	202841	136	246000	240
192575	254	200026	188	200345	143	202842	136	270055	243
192576	254	200028	194	200346	143	202843	136	270060	243
192932	100	200029	192	200347	143	202844	136	272301	288
192933	100	200034	201	200349	143	202845	99	272303	288
192934	100	200037	201	200351	56, 143	202846	99	272304	288
192935	100	200050	203	200356	142	202847	99	282305	287
192950	101	200060	203	200357	143	202848	136	282306	287

<b>code</b>	<b>page</b>	<b>code</b>	<b>page</b>	<b>code</b>	<b>page</b>	<b>code</b>	<b>page</b>	<b>code</b>	<b>page</b>
282310	288	300800	150	310202	15	407003	138	409702	129
282311	288	300807	40, 63, 157	318000	197	407005	139	409703	128
282320	53	300808	40, 63, 157	318001	197	407006	139	409711	130
282321	53	300903	153	318002	197	407008	138	409726	129
282323	53	300904	153	318003	197	408001	137	409752	128
282324	53	300907	153	318006	197	408002	79, 181	409756	128
282330	53	300908	153	318009	197	408003	79, 181	409766	51
282331	53	301200	154	350002	267	408005	79, 181	409802	125
282333	53	301201	154	350004	267	408025	254	409826	125
282334	53	301202	154	350013	267	408050	254	409852	125
282340	52	301212	154	350024	267	408100	254	409902	130
282341	52	301213	154	350034	267	408250	254	420046	140
282350	52	301402	40, 157	350035	267	408500	254	420056	140
282351	52	301403	40, 157	350037	267	408600	135	429900	43, 159
292601	54	301700	151	350046	267	408601	135	429901	43, 159
292602	54	302000	93	350048	267	408610	135	429910	43, 159
292605	54	302100	93	350051	267	408702	134	429920	43, 159
292606	54	302400	93	350057	267	408720	134	429926	43, 159
292819	289	302713	38	350059	267	408721	134	429927	43, 159
292820	289	302714	38	350069	267	408726	134	429930	41, 62, 158
292821	289	302733	38	350079	267	409001	66, 174	429931	41, 62, 158
300100	151	302734	38	350610	267	409002	66, 174	429940	41, 62, 158
300200	15	302743	39	350612	267	409003	66, 174	429942	41, 62, 158
300201	15	302744	39	350710	267	409004	79, 181	429945	41, 62, 158
300202	15	302745	39	350810	267	409005	78, 358	429946	42, 159
300203	15	302753	39	350812	267	409009	78, 180	429950	41, 62, 158
300205	14	302754	39	350814	267	409010	78, 180	429951	41, 62, 158
300210	15	302755	39	350912	267	409011	78, 180	430130	141
300230	14	302762	37	350915	267	409012	78, 180	440131	100
300232	14	302764	37	351014	267	409050	256	440132	100
300243	14	302780	37	351420	267	409100	256	440139	100
300250	16	302792	37	351622	267	409107	66, 174	440141	101
300251	16	302794	37	352030	267	409108	66, 174	440142	147
300252	16	303100	93	400400	152	409109	66, 174	440143	101
300253	16	303101	93	400500	152	409110	175	440144	101
300260	14	303102	93	400700	152	409120	175	440147	101
300261	16	303103	93	400705	152	409132	175	440149	101
300263	16	304000	93	400800	152	409135	175	440150	147
300264	21	304210	24	401100	152	409202	123	440151	147
300267	21	304211	24	401200	154	409222	123	440161	104
300280	19	308502	155	401201	154	409250	256	440171	104
300281	18	308506	155	401204	154	409402	124	440181	104
300285	18	308602	155	401301	89	409426	124	440191	104
300287	18	309202	122	401302	89	409500	256	441142	250
300290	19	309222	122	401402	40, 157	409501	127	444142	147
300291	19	309316	131	401403	40, 157	409502	127	444150	147
300295	19	309324	131	401410	66, 174	409511	130	444242	147
300300	150	309402	124	401700	152	409520	133	444608	283
300400	150	309502	126	402001	275	409526	127	444609	283
300500	150	309526	126	402002	275	409531	133	444610	283
300700	151	309552	126	402005	275	409552	127	444611	283
300702	153	309752	129	402010	275	409602	123	444612	283
300704	153	309903	130	402020	275	409700	129	444613	283
300705	151	310200	15	407001	138	409701	129	444614	283

code	page	code	page	code	page	code	page	code	page
445140	103	617402	161	900074	146	979930	116	100-6006	49
445141	103	621101	91	900076	146	983045	55	100-6007	49
445143	103	621610	91	900078	146	983047	56, 236	100-6008	49
445145	103	621611	91	900093	73	989910	115	1020LG	253
445147	103	621613	91	900095	73	989919	115	1020LM	253
454140	102	668811	38	900098	73	989921	115	1020LP	253
454141	102	701034	155	900100	95	989945	115	182295F	131
454147	102	701061	155	900101	95	989951	110	191221.1	246
454148	102	705000	92	900110	74	989952	110	191221.2	246
454241	102	705595	155	900111	74	989953	110	191221.3	246
470000	282	705722	155	900112	75	989956	115	191221.4	246
470001	282	707094	85	900117	165	999802	200	191221.5	246
470002	282	713100	163	900118	165	1501118	91	191221.6	246
470003	282	716100	163	900122	74	1501308	91	191221/1	246
470005	282	716125	163	900123	73	1501418	91	191221/2	246
470007	282	716150	163	900156	77	1501818	91	191221/3	246
481000	254	801075	162	900170	77	1911103	265	191221/4	246
482000	254	801275	162	900198	77	1911104	265	191221/5	246
490050	257	805000	111	900204	164	1911105	265	191221/6	246
490100	257	805001	111	900205	164	1911106	265	191637.04	249
490250	257	805013	111	900211	164	1911107	265	191637.06	249
490400	257	805040	111	900212	164	1911108	265	191637.10	249
490900	257	805050	111	900220	164	1911110	265	191638.04	249
491000	256	805120	111	900225	164	1911111	265	191638.06	249
492000	256	805130	111	900300	76	1911112	265	191638.10	249
493000	256	805140	111	900301	76	1911114	265	19274.5	119
495000	256	805150	111	900305	76	44270000	286	19276.1	118
554140	102	806030	111	900306	77	44280000	286	19276.A	117
554141	102	808000	111	900310	77	44300000	249	19276.B	117
554147	102	808001	111	900320	76	44310000	249	19277.1	118
554148	102	808100	111	900330	76	430100100	141	19277.B	117
555260	104	808101	111	900384	70	444602903	141	19278.2	118
555262	104	808200	111	900400	269	444603202	141	19278.3	118
555264	104	813100	162	900600	269	444603204	141	19278.A	117
555265	104	816100	162	901030	246	444603300	141	19278.B	117
600300	85	816150	162	901031	246	444603402	141	19279.5	119
600400	85	816160	162	901075	162	200070NR	191	19279.7	119
600602	83	818150	162	901275	162	100-1001	47	192922.04	100
600800	84	820150	162	901407	226	100-1002	47	19400.1	269
600801	84	900007	165	901410	226	100-1003	47	19591/T	251
601402	87	900008	95	901531	241	100-1004	47	199014N	187
601603	87	900010	36	901533	241	100-2001	47	199014RC	187
601702	87	900011	36	901600	110	100-3001	48	199076RC	190
601802	86	900012	36	910022	94	100-3002	48	199078N	187
601803	86	900015	36	910023	95	100-4001	48	199078RC	187
602002	86	900019	94	910026	95	100-4002	48	199084RC	185
602003	86	900020	95	913100	162	100-4003	48	200003.CC	201
611603	87	900022	94	916100	162	100-4004	48	200006.CC	201
611604	87	900023	94	916150	162	100-5001	49	200009B	189
617000	163	900024	94	917000	164	100-5002	49	200009R	189
617100	163	900025	116	918000	164	100-6001	49	200009REF	189, 195
617145	163	900028	116	918150	162	100-6002	49	200010FR	186
617200	163	900050	204	922000	164	100-6004	49	200012B	191
617300	163	900073	146	928000	164	100-6005	49	200012R	191

code	page	code	page	code	page	code	page	code	page
200012REF	191	202828G	279	3071**	155	409003V	174	4092.6N	168
200014FR	195	202911N	283	3072**	155	409007.M	64, 172	4092.6NS	168
200014R	195	202912N	283	3081**	155	409007.N	64, 172	4092.7N	169
200015R	196	202913N	283	3082**	155	409008.M	64, 172	4092.8N	169
200015RF	196	202914N	283	309222.0	122	409008.N	64, 172	409202.B	124
200016B	187	202915N	283	309324.E3	131	4091.1N	167	409222.0	123
200016R	187	202916N	283	309324.PS	131	409102.1	175	4094.1A	67
200016REF	187, 195	282323.BU	53	310206K	21	409103.1	66, 174	4094.1AM	67
200028R	194	282324.BU	53	310207K	21	409105.1	66, 174	4094.1N	67
200028RF	194	292819G	288	319324.E10	131	409106.1	66, 174	4094.1R	67
200029F	192	300212.1	15	319324.E13	131	409106.2	175	4094.2A	70
200029R	192	300252DNA	16, 66	326-19	185	409107.1	175	4094.2AM	70
200029RF	192	300260.1	14	326-37	185	409108.1	175	4094.2N	70
200032.0	201	300280.2	19	327-16	192	409109.1	175	4094.2R	70
200062.0	201	300281/1	18	327-19	185	409110.1	64, 172	4094.3N	68
200070R	191	300284.SE	18	327-23	186	409110.2	64, 172	4094.4N	68
200071NR	192	300299.SE	20	327-24	186	409110.2T	65, 173	4094.5BP	69
200075RF	194	300800.1	150	327-30	191	409110.3	64, 172	4094.5N	67
200076R	190	300800.2	150	327-30R	191	409110.4	64, 172	4095.1BP	69
200076RF	188, 190	300900*	151	327-31R	192	409110.4T	65, 173	4095.1N	68
200077F	191	301-01	185	327-33	187	409110/1	175	4095.1NP	68
200077FR	191	301-01F	185	327-33R	187	409110/4	175	4095.2N	68
200077R	191	301-01FR	185	327-34	187	409111/2	65, 173	4095.4N	68
200079FS	188	301-01R	185	327-34R	187	409111/3	65, 173	4095.5N	70
200079R	188	301-09	185	327-36	186	409111/4	65, 173	4095.6N	68
200080.1	192	301-10	185	327-36R	186	409111/5	65, 173	4095.7N	68
200080.1R	192	301-11	185	327-37R	185	409111/6	65, 173	4095.9N	67
200082F	192	301403.G	157	327-40	189	409111/7	65, 173	409502G	126
200082NR	192	304213KF	24	400800.1	152	409112/0	65, 173	409502G.4	126
200082R	192	304221KF	22	400900*	152	409112/1	65, 173	409526.1	127
200083R	196	304222KF	22	4020NG	253	409112/2	65, 173	409526.0	127
200200.4	32	304223KF	22	4020NM	253	409112/4	65, 173	409526G	126
200200.5	33	304224KF	22	4020NP	253	409112/6	65, 173	4096.2N	68
200200E	32	304225F	22	407001/T	138	409113.1	64, 172	4096.3N	68
200201.B	33	304230F	23	407001OBT	138	409113.2	64, 172	409726.G	129
200204A	33	304233.2S	23	407005.0	139	409113.3	64, 172	409756.B	128
200209E	32	304233F	23	407005/T	139	409113.4	64, 172	429900SP	43, 159
200393.VSP	57	304234KF	23	407006/T	139	409113/1	25	429926.10	43, 159
200393P	57	304236KF	23	407008.0	138	409113/2	25	429926.25	43, 159
200396P	31	304238KF	23	407008OBT	138	409113/3	25	429927.10	43, 159
200400P	166	304239KF	23	408001.1	137	409113/4	25	429927.25	43, 159
200500.1	37	304243KF	23	408001.0	137	409113/5	25	430100.1	141
200510.1	37	304243KFI	23	4080010/T	137	409113/6	25	430130.1	141
202620N	293	304244K	27	408001OBT	137	409115/2	64, 172	440139D	100
202802.1	278	304260KF	22	408702.G	134	409115/3	64, 172	440142.0	147
202802B	278	304305KF	23	408726.G	134	409115/4	64, 172	441142.1	250
202813.10	279	304305KF.2S	23	408900.K	134	409115/6	64, 172	441142.2	250
202814.1	278	304305KFI	23	408910.K	134	4092.1N	166	441242.2	250
202815B.0	279	3050**	155	409002.1	66, 174	4092.1NS	166	617000*	163
202820.0	279	3053**	155	409003.1	66, 174	4092.2N	168	720.1	137
202821.E3	279	3055**	155	409003.2	66, 174	4092.3N*	168	770000P	198
202821E	279	3058**	155	409003A	174	4092.3NS	168	770005P	198
202821E.1	98, 279	3066**	155	409003AM	174	4092.4N	167	770040P	198
202823.1	279	3070**	155	409003R	174	4092.5N	167	770050P	198

code	page	code	page	code	page	code	page	code	page
770060P	198	C-256	233	D-240	164, 233	M 250330	144	M-213	200
770070P	198	C05	251	D-250	164, 233	M 300400	144	M-300	234
770080P	198	D01	251	D300000	62	M 5555	144	M-410	215
770110P	198	D03	251	D300001	62	M 5555B	144	M-450	215
770210P	198	D100001	107	D300002	62	M 6080	144	M-500	215
770220P	198	D100002	107	D300003	62	M 6080B	144	M-501	215
770240P	198	D100003	107	D300004	62	M 70100	144	M-502	215
770320P	198	D100004	107	D300005	62	M 70110B	144	M-503	215
770340P	198	D100005	107	DS10	105	M 80120	144	M-510	215
801175T	162	D100006	107	DS36	105	M 80120B	144	M-511	215
900010.1	36	D100010	109	DS40	106	M 80160	144	M-512	215
900011.1	36	D100011	109	DS42	106	M-010.1	216	M-513	215
900012.1	36	D100018	109	DS51	105	M-010.2	216	M-520	223
900015.1	36	D100019	109	DS52	105	M-010.5	216	M-521	223
900030.C	45, 63, 205	D100024	109	DS63	105	M-010.6	216	M-522	223
900031.C	45, 63, 205	D100025	109	F-210	232	M-010.7	216	M-523	223
900032.1C	204	D101818	107	FB534S	179	M-015	220	M-540	220
900032.C	45, 63, 205	D102020	107	FB545S	179	M-020AM	212	M-541	220
900033.C	45, 63, 205	D102222	107	GS-02	83	M-020N	212	M-542	220
900034.C	45, 63, 205	D102240	107	H-200	237	M-020R	212	M-550	220
900036.C	45, 63, 205	D102424	107	H-210	237	M-020V	212	M-551	220
900037.C	45, 63, 205	D102432	107	H-215	237	M-021AM	221	M-552	220
900038.C	45, 63, 205	D102440	107	H-220	237	M-021R	221	M-553	220
900041.C	45, 63, 205	D102450	107	H-290	237	M-021V	221	M-554	221
900043.C	45, 63, 205	D102460	107	H-600	34	M-022	218	M-560A	226
900113B	75	D-200	164	H-601	34	M-024	218	M-561A	226
900130.C	45, 63, 205	D200001	60	H-610	35	M-026	218	M-563A	216
900136.C	45, 63, 205	D200002	60	H-611	35	M-028.5	219	M-563NA	216
900144.C	45, 63, 205	D200003	60	H-615	36	M-028.6	219	M-570	218
900146.C	45, 63, 205	D200004	60	H-626	34	M-033AM	211	M-571	218
901031.2	246	D200005	60	H-627	34	M-033R	211	M-572	217
A100010	108	D200006	60	I-240	127, 235	M-033V	211	M-581	217
A100011	108	D200010	60	I-250	127	M-034AM	211	M-585	217
A100013	108	D200011	60	JS1	89, 145	M-035AM	211	M-600	214
A100014	108	D200012	60	JS2	89, 145	M-035R	211	M-603	214
A100018	108	D200013	60	JS3	89, 145	M-035V	211	M-606	214
A100019	108	D200014	60	JS4	89, 145	M-036AM	210	M-607	214
A-200	232	D200015	60	JS5	89, 145	M-036B	210	M-610	214
A-201	232	D200020	60	JS6	89, 145	M-050	222	M-640	221
A20100	110	D200021	60	JS8	89, 145	M-060	222	M-641	221
A-202	232	D200022	60	JS9	89, 145	M-061AM	210	MLTSTD2	200
A20250	110	D200023	60	L-240	235	M-061NA	210	N 160230	144
A20500	110	D200024	60	L-250	235	M-062B	210	N-240	235
A-210	232	D200025	60	M 100150	144	M-062R	210	N-250	235
A-211	232	D200030	61	M 100150B	144	M-063B	210	NPP-10	199
A-212	232	D200031	61	M 110110	144	M-063R	210	NPP-100	199
A-231	232	D200032	61	M 120180	144	M-064AM	210	NPP-1000	199
A-240	232	D200033	61	M 120180B	144	M-064V	210	NPP-10000	199
A-250	232	D200034	61	M 150220	144	M-100	222	NPP-2	199
B-200	232	D200035	61	M 160220B	144	M-201	200	NPP-20	199
BOX-RN1000	195	D200060	61	M 180250	144	M-203	200	NPP-200	199
BOX-RN300	195	D200100	61	M 180250B	144	M-205	200	NPP-5000	199
C-211	233	D200150	61	M 200300	144	M-211	200	NPX2-10	199
C-254	233	D-230	164, 233	M 200300B	144	M-212	200	NPX2-100	199

code	page
NPX2-1000	199
NPX2-10ML	199
NPX2-2	199
NPX2-20	199
NPX2-200	199
NPX2-5000	199
P0100000	89
R-215	237
R-240	237
R-250	237
R-281	234
R-282	234
R-283	234
R-292	234
R-293	234
RC845TP	78, 180
S-003	114, 237
S-004	114, 237
T-200	236
TQ	83
U-0537A	214
U-0537N	214
U-105105A	229
U-1145A	227
U-1145N	227
U-1170A	227
U-1170N	227
U-15128A	229
U-15128AM	229
U-15128N	229
U-4445A	214
U-4445N	214
U-50128A	226
U-50128R	226
U-50128V	226
U-7750A	213
U-7750N	213
U-7780A	228
U-7780N	228
U-7780NA	228
U-7796V	228
U-8845A	213
U-8850A	213
U-9581N	212
U-9950CAM	212
U-9950CN	212
U-9950CNA	212
U-9950CR	212
U-9950CV	212
U-9970A	227
U-9980A	228
U-9980N	228
U-9996A	229
U-9996N	229

code	page
V 160230	144
W000050	178
W000059CL	178
W000120	178
W000129CL	178
W001400	178
W030940	179
W051100	176
W052960CL	177
W053100	177
W053960CL	177
W058100	176
W-100	44, 207, 248
W-110	44, 207, 248
W-120	44, 207, 248
W121100	176
W122960CL	177
W123100	177
W123960CL	177
W128100	176
W128960	176
W310990	179
W350900	179
W350990	179
W370900	179
W370990	179
W990000	178
W990001	178
W990002	178
W990003	178
W990004	178
W999600	178
W999601	178
W999602	178
W999603	178
W999604	178
Z-050	231
Z-075	231
Z-100	231
Z-250	231
Z-300	231
Z-500	231
Z-600	231
Z-700	231
Z-800	231

Direction and coordination  
Brand & Communication, DELTALAB member of SCGP

Photography  
Files of DELTALAB member of SCGP  
Christian Ribas

Graphic concept, design and digital image  
Brand & Communication, DELTALAB member of SCGP

Printed by  
VANGUARD GRÀFIC S.A.

Printed in Spain

November, 2024

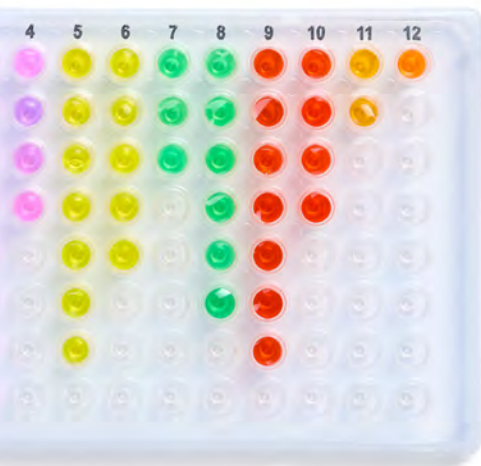

 **deltalab**  
member of **SCGP**

Plaza de la Verneda, 1 P. I. La Llana  
08191 Rubí · Barcelona · Spain  
T. +34 93 699 50 00 · F. +34 93 699 45 12  
info@deltalabgroup.com · www.deltalabgroup.com